

Scintillating Fibres – Tracking Particles With (a little) Light

The new Fibre Tracker for LHCb

Christian Joram
CERN, EP-DT

CBPF, Rio de Janeiro
01/09/2017

Outline

- LHCb LS2 upgrade
- What are **scintillating fibres** and how do they work?
- How can we **track particles** with scintillating fibres ?
- A bit of **history**
- A few slides on **Silicon Photomultipliers (SiPM)**
- The **LHCb SciFi Tracker**
- What makes it **difficult** (and interesting)?

- LHCb is an atypical collider experiment with classic fixed target geometry.
- Its mission is to measure rare phenomena in the beauty and charm sector in particular CP violation, and to look for signs of new physics (beyond the standard model).
- For this purpose it has powerful vertexing, tracking, calorimetry, particle identification
- It's in operation since 2010.

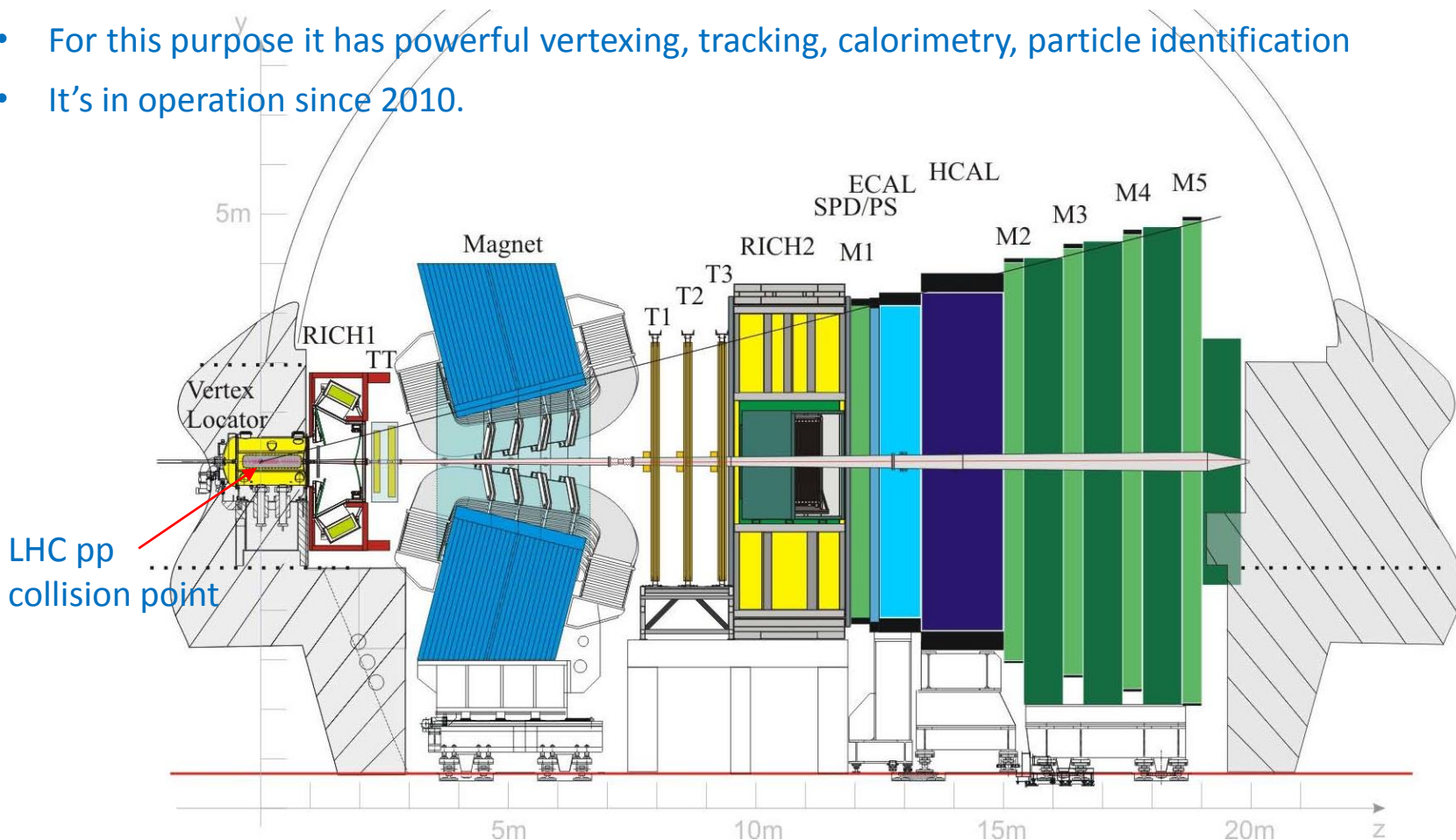

- In 2019/2020 (during LHC Long Shutdown 2), LHCb will undergo a very major upgrade.
 - 5x higher instantaneous luminosity. Aim for 50 /fb over 10 years.
 - Three detectors will be replaced. All other detectors obtain fast 40 MHz readout electronics.
 - Full software trigger for every bunch crossing.
- New VELO, Si pixel based
 - New Upstream tracker (UT), Si- μ strip
 - SciFi Tracker, scintillating fibres

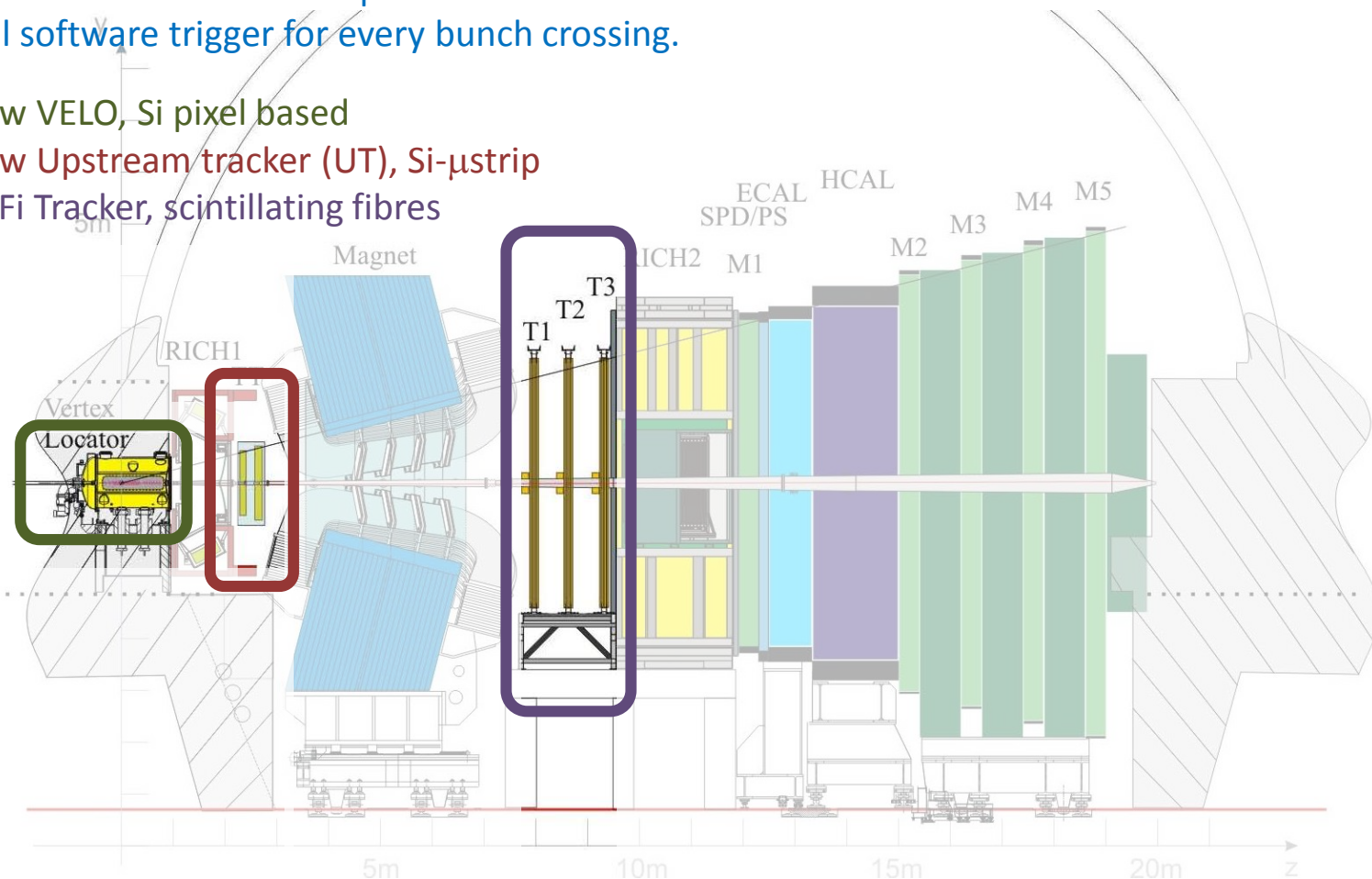

Why to replace the Outer Tracker?

OT technology: Straw tubes, i.e. cylindrical drift tubes

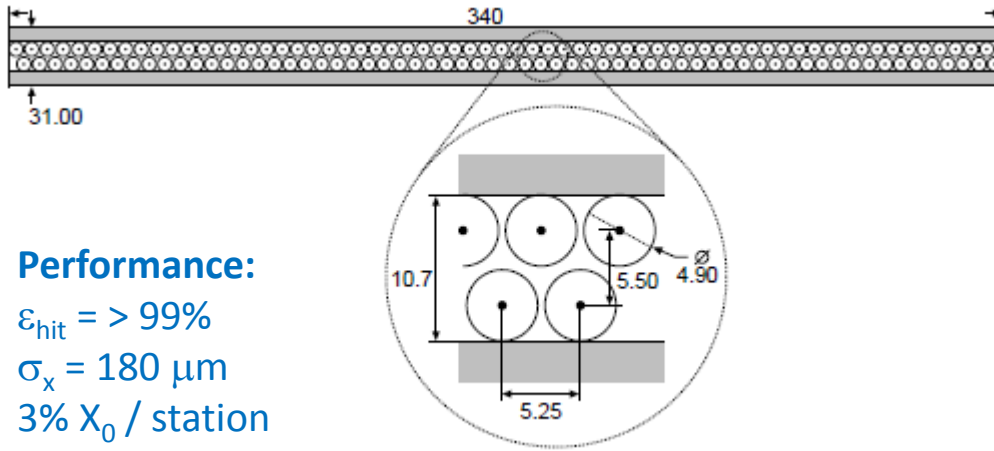

Performance:

- $\epsilon_{hit} = > 99\%$
- $\sigma_x = 180 \mu\text{m}$
- 3% X_0 / station

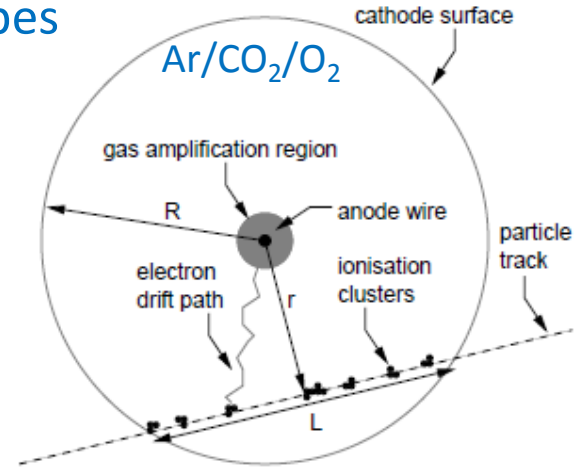

Drift time ≤ 50 ns

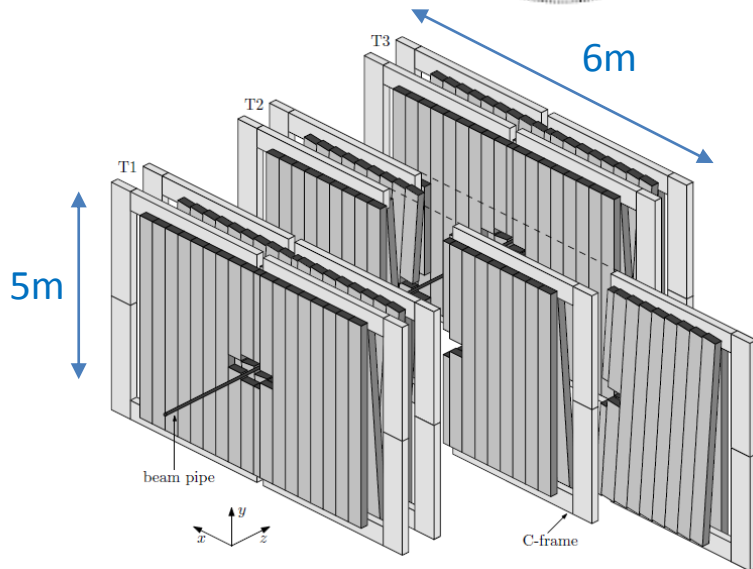

Issues when upgrading the luminosity at LHCb by a factor 5 and switching to 40 MHz readout:

- drift time will spill over to next measurement
- occupancy of straws will approach 100%



The region close to the beam pipe is complemented by the Inner Tracker (Si micro strip technology).

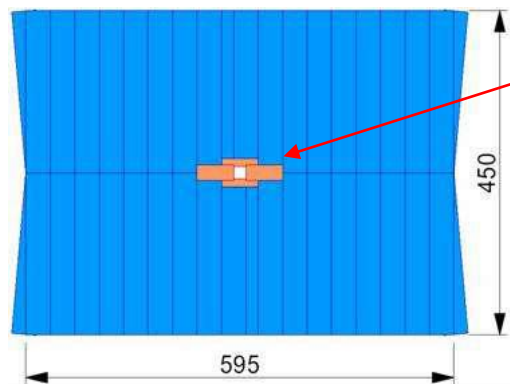

2% of the area
20% of the tracks

- No intrinsic performance issue.
- New 40 MHz readout needed
- IT area would need to be enlarged
- Integration of a Si tracker in the middle of another detector is a mess → up to 30% X_0 of material.

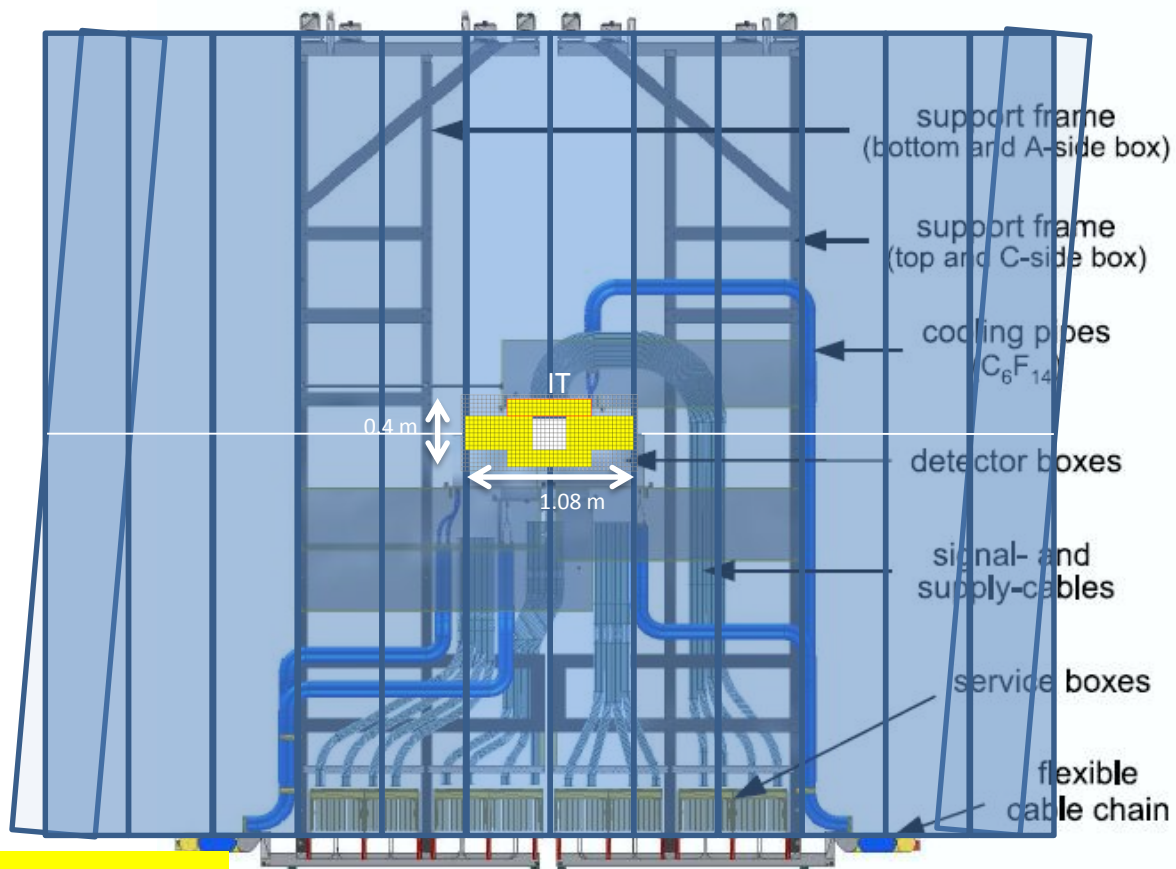

→ Replace both IT and OT by a single technology

What are scintillating fibres and how do they work?

What is a scintillator ?

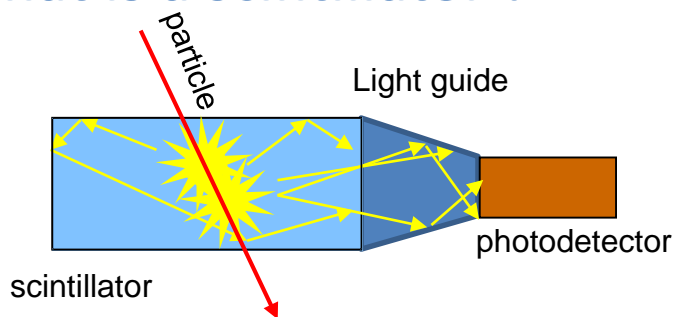

Energy deposition by an ionizing particle or photon (γ)

- generation
- transmission
- detection

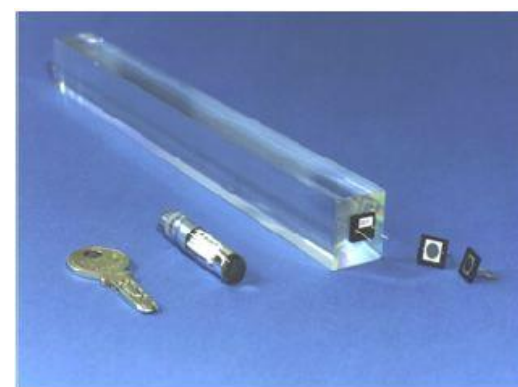

Two categories



Organic scintillators (plastics or liquid solutions)

- Polystyrene + some dopants
- Little light (<math> < 10^4 </math> photons / MeV)
- Low density $\rho \sim 1\text{g/cm}^3$
- Fast (ns)
- Cheap
- Radiation “soft”
- Can be used for fibres!

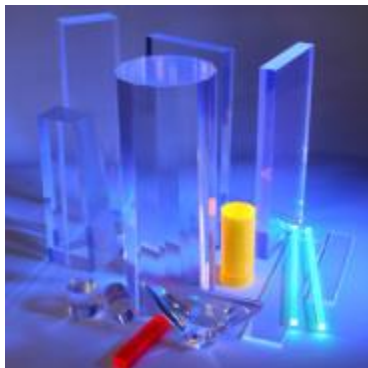

Inorganic (crystals)

- More light (up to 70000 ph/MeV)
- High density $\rho \sim 5\text{-}10\text{ g/cm}^3$
- Expensive



Don't confuse scintillators with lead glass !



The light generation in lead glass is actually based on the Cherenkov effect. Lead glass is the poor man's crystal. High density, but little light output.

Refraction

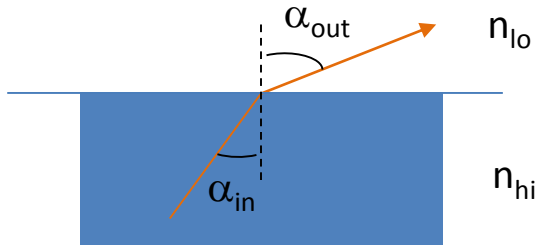

Total internal reflection

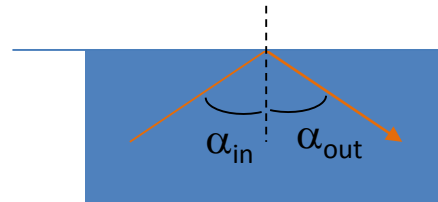

$$\alpha_{crit} = \text{asin}(n_{lo}/n_{hi})$$

$$\alpha_{in} > \alpha_{crit} \rightarrow \alpha_{out} = \alpha_{in} \quad R = 100\%$$

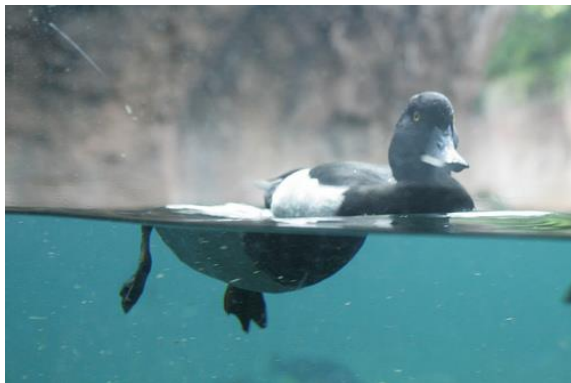

α_{crit}

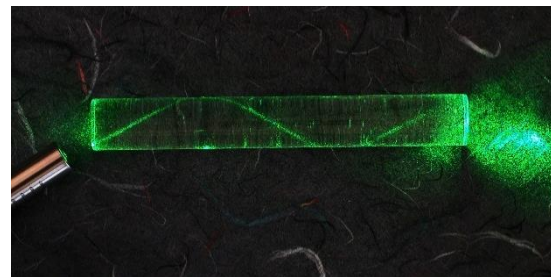

Jean-Daniel Colladon, a 38-year-old Swiss professor at **University of Geneva**, demonstrated (by accident) light guiding or **total internal reflection** for the first time in **1841**.

He had actually studied law (!) and worked on speed of sound in water and water jets.

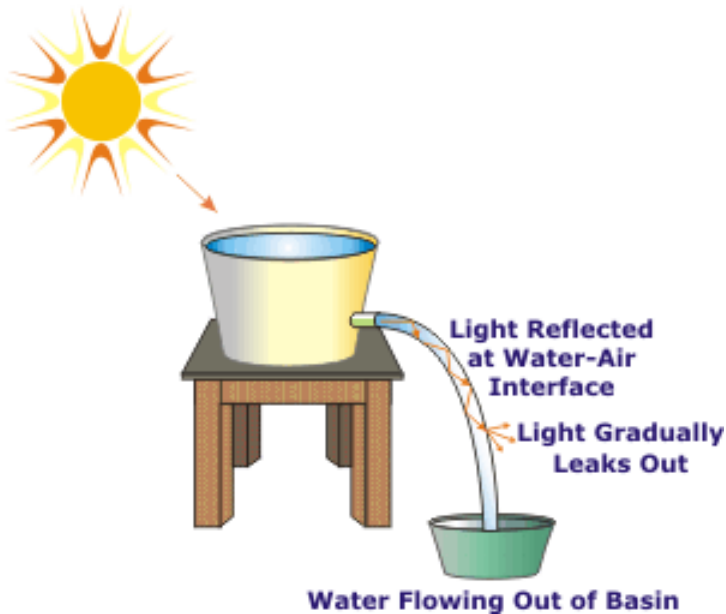

Basics of scintillating fibres

- Scintillating fibre = Polystyrene (PS) core + plexiglass (PMMA) cladding

$n \sim 1.59$

$n \sim 1.49$

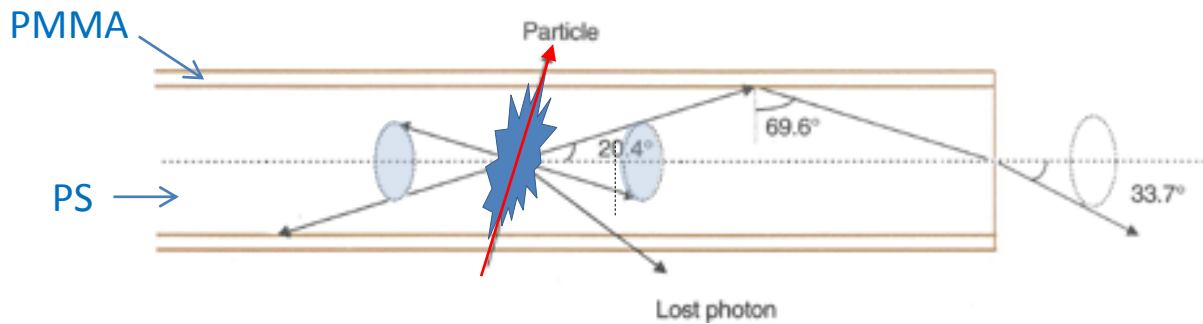

$$\theta_{crit} = \text{asin}\left(\frac{1.49}{1.59}\right) = 69.6^\circ$$

$$\epsilon_{trap} \geq \frac{1}{4\pi} \int_0^{20.4^\circ} 2\pi \sin\theta d\theta$$

$$\geq 3.1\% \quad (\text{per side})$$

- Why \geq ?

There are also 'cladding rays' and helical paths. They usually survive only over short distances.

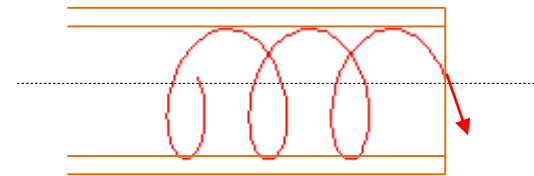
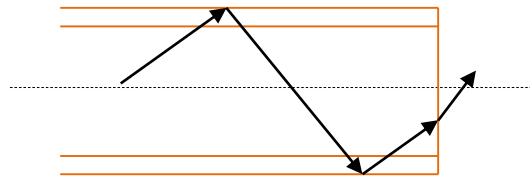

- **Double cladded fibres** make use of an extra layer of a fluorinated polymer with lower refractive index ($n = 1.42$) (CERN RD7 / Kuraray 1990). This is still state-of-the-art!

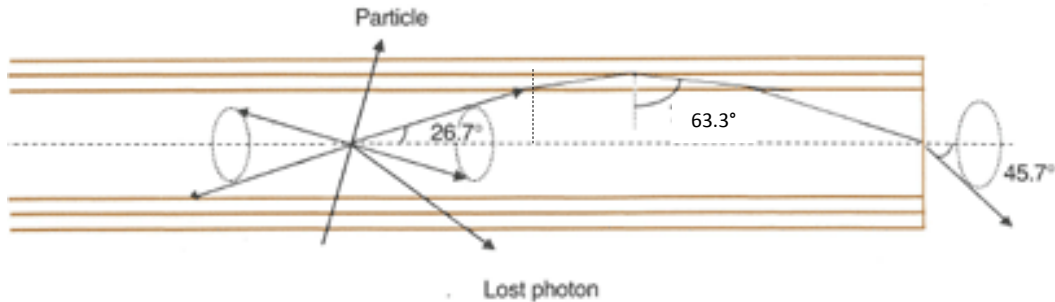

$$\epsilon_{trap} \geq \frac{1}{4\pi} \int_0^{26.7^\circ} 2\pi \sin\theta d\theta$$

$$\geq 5.4\% \quad (\text{per side})$$

- Scintillating fibres exist also in **other geometries and flavours**

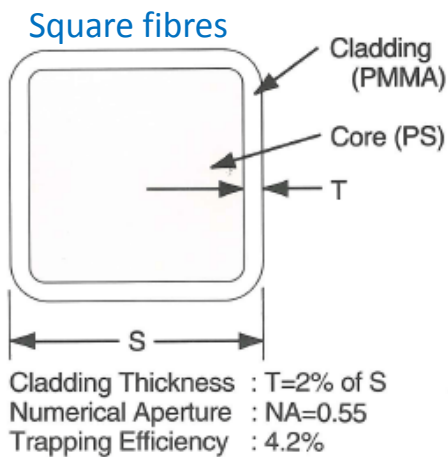

C.D. Ambrosio et al.,
NIM A 325 (1993), 161

glass capillaries with
liquid scintillator

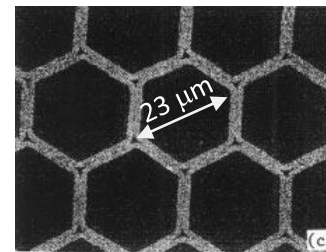

Annis P, et al. NIM A367
(1995) 377

Micro-fluidic detector study

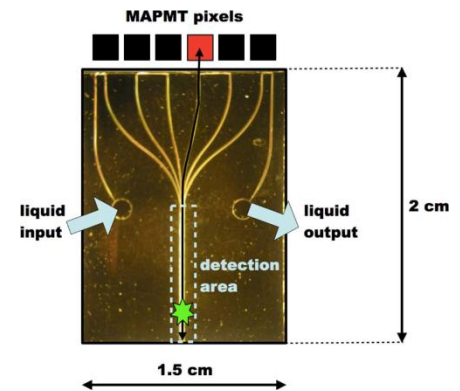

A. Mapelli et al., IEEE TNS
58, NO. 3, JUNE 2011

Emission spectrum of Kuraray SCSF-78 fibre

(baseline for LHCb Tracker TDR)

as function of distance from excitation point

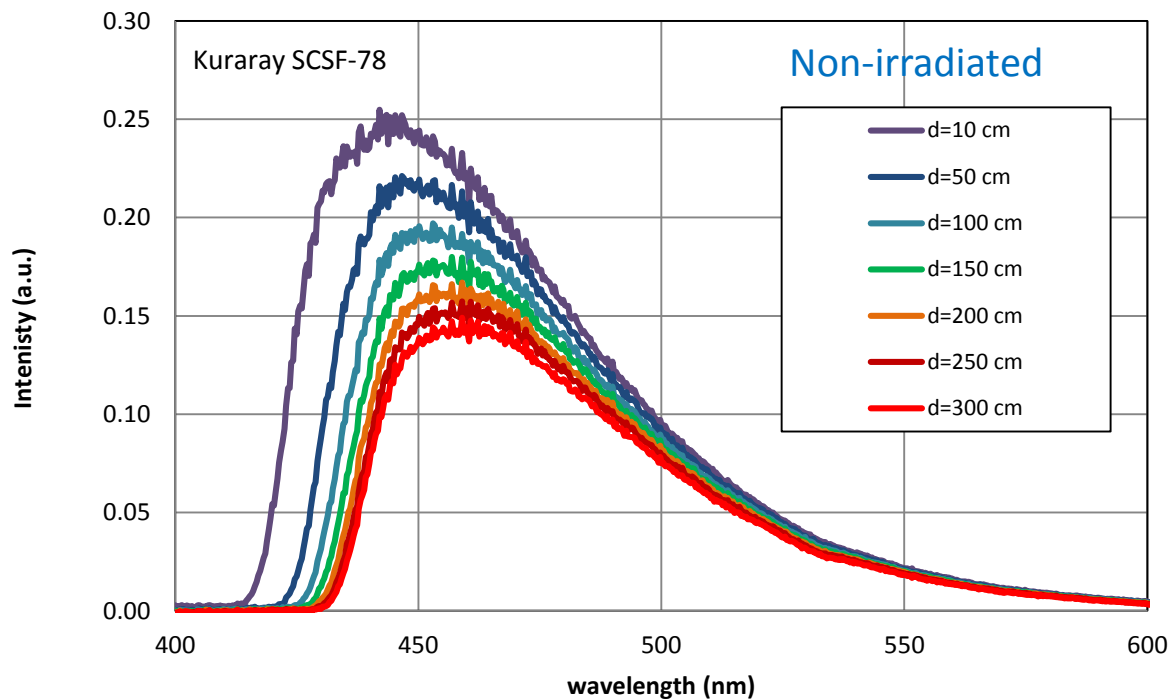
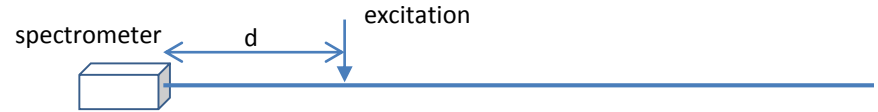

- Light is attenuated during propagation
- Blue light is stronger absorbed than green and red

$$I = I_0 \cdot e^{-\frac{d}{\Lambda}}$$

$\Lambda(\lambda)$ attenuation length

Attenuation in a 3.5 m long SCSF-78 fibre (\varnothing 0.25 mm) in air, averaged over emission spectrum

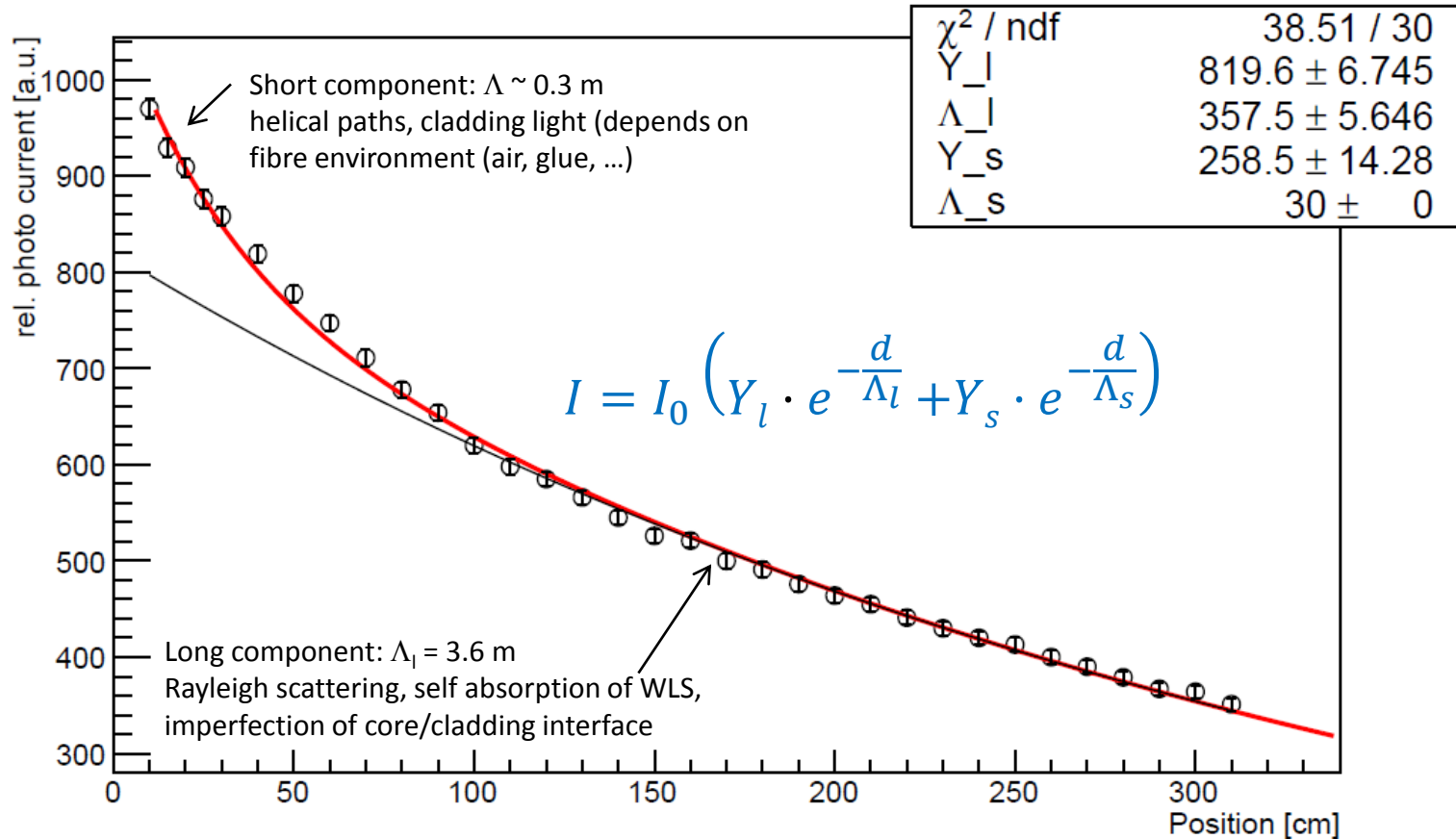

How can we track particles with scintillating fibres ?

Tracking = localising particles along their path

- High resolution → use thin fibres
- High efficiency → use thick fibres
- Low background ● → low noise photodetectors

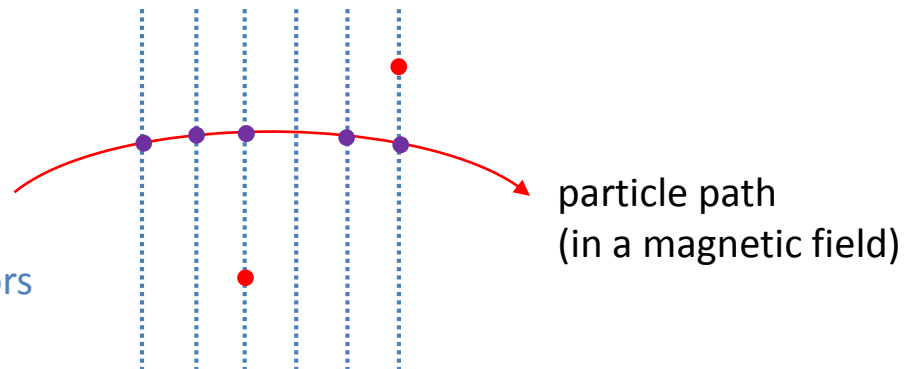

Future location of our SciFi tracker in LHCb

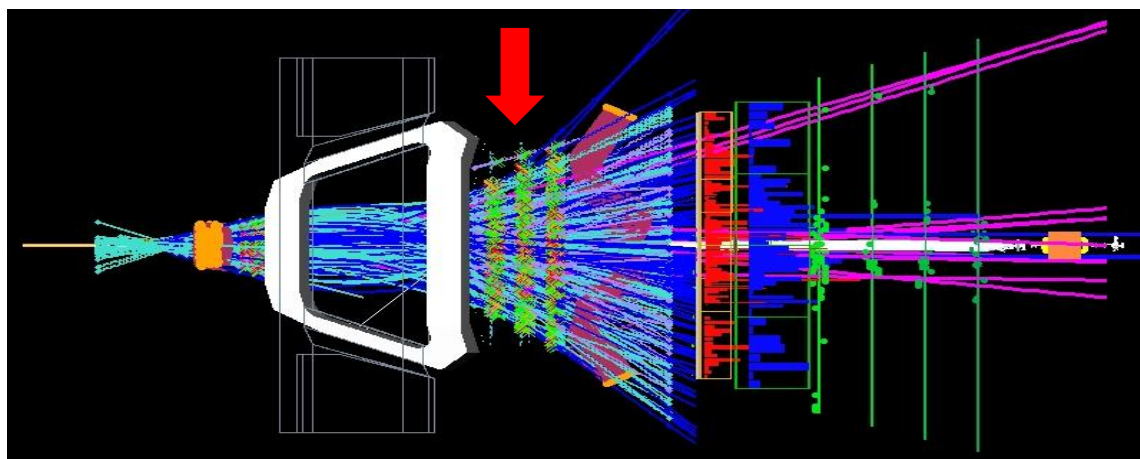

Trackers based on scintillating fibres

- Fibres give lots of geometrical flexibility
- They have low mass and are (almost) self supporting
- All non-active material can be at the end of the fibres

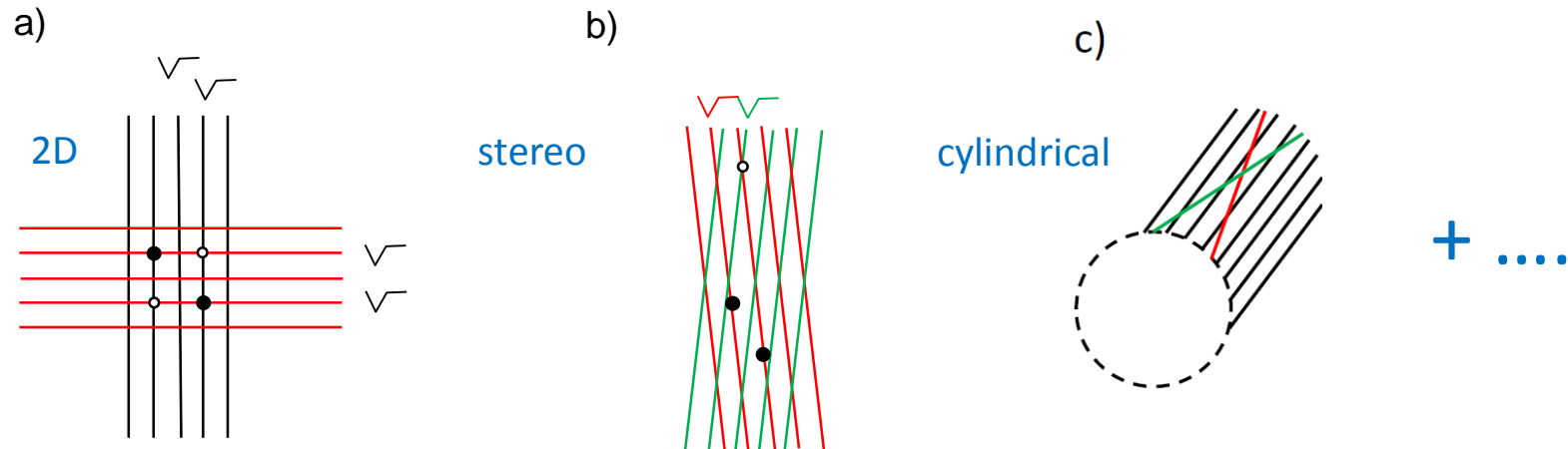

But ...

- Fibres give relatively little light
- They are non very radiation hard
- Building a fibre tracker is a lot of work (companies just deliver fibres)

Back-of-the-envelope estimate of photoelectric yield in a 0.25 mm double cladded fibre, 2 m from photodetector. Non-irradiated.

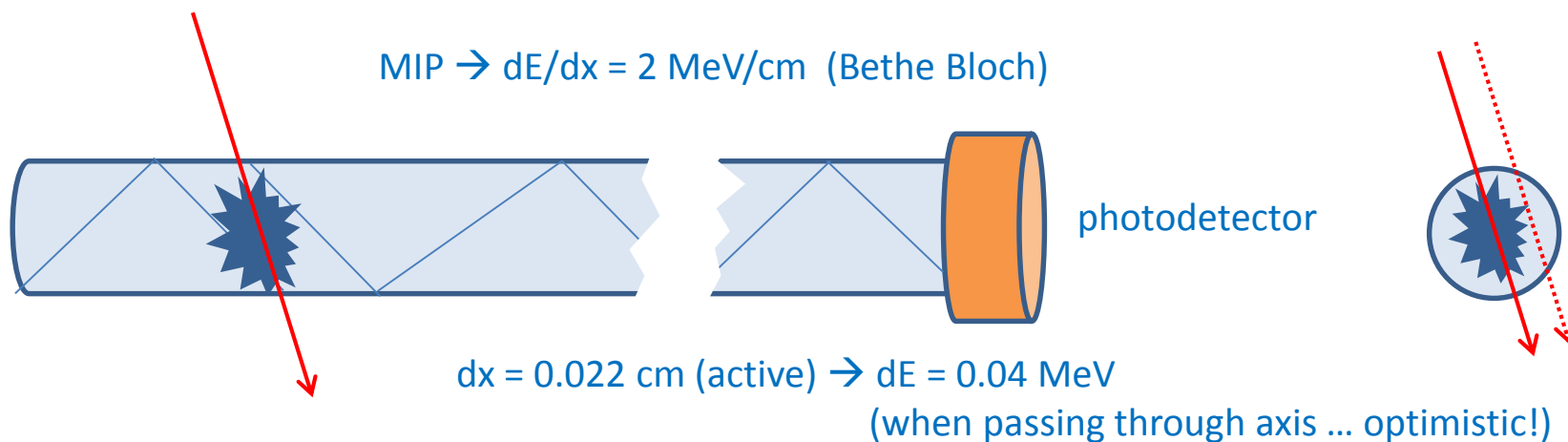

- Scintillation yield: $dY_\gamma/dE = 8000 \text{ ph / MeV}$
- Trapping inside fibre (1 hemisphere): 5.4%
- Attenuation losses over 2 m: 50%
- Efficiency of photodetector (typ. PMT): 20%

$$\rightarrow Y_\gamma = 320$$

$$\rightarrow Y_\gamma \sim 16$$

$$\rightarrow Y_\gamma \sim 8$$

$$\rightarrow Y_{\text{p.e.}} \sim 1-2$$

VERY little light !

- \rightarrow Need more traversed fibre thickness
- \rightarrow Need higher photodetector efficiency
- \rightarrow Need to recover light in the second hemisphere

A bit of SciFi history

A bit of history

After the discovery of Colladon (1841), it took **116 years** before scintillating fibres were used as particle detectors

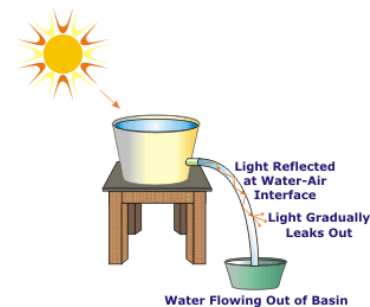

Filament Scintillation Counter*

Rev. Sci. Instrum. 28, 1098 (1957);

GEORGE T. REYNOLDS AND P. E. CONDON

*Palmer Physical Laboratory, Princeton University,
Princeton, New Jersey*

The above result indicates that a minimum ionizing particle passing through a filament of 1-mm diameter (index of refraction 1.58) would, on the average, result in 110 photons appearing at the end of the filament,

..... . Viewed with image intensifier tubes currently being developed,^{3,4} these filaments would provide a solid scintillation chamber capable of fast timing and good space resolution

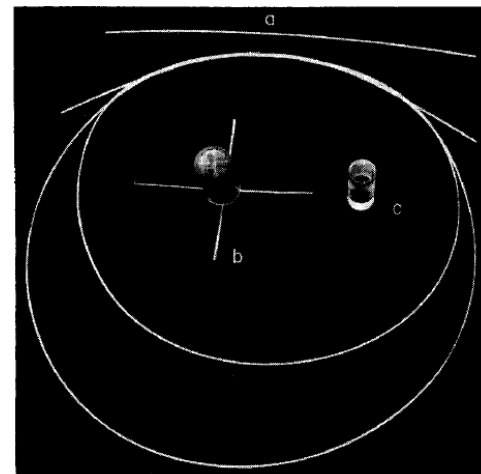

First (?) non-cladded scintillating plastic fibre.

Upgrade of the **UA2** experiment (1985-87).

J. Alitti et al. , NIM A 273 (1988) 135

The first major collider application of scintillating fibre tracking technology.

- Outer tracking and pre-shower measurement for electron identification.
- **60,000** single-clad, blue-emitting scintillating fibres of **1 mm in diameter** and 2.1 m long
- developed and produced (!) at Saclay. $\Lambda > 1.5$ m.
- Light propagates to 32 collector plates which are readout by **32 image-intensified CCDs** (32000 pixels each).

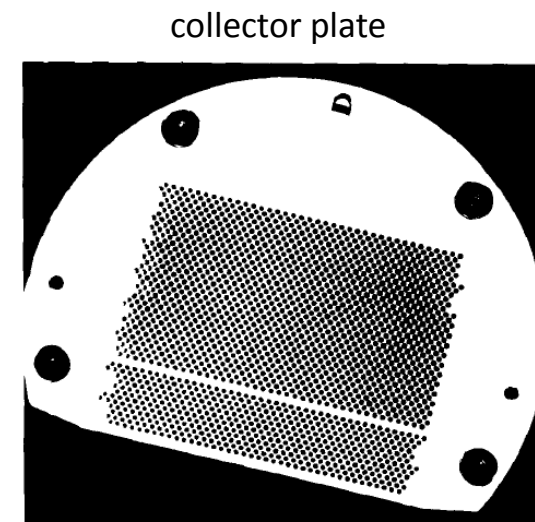
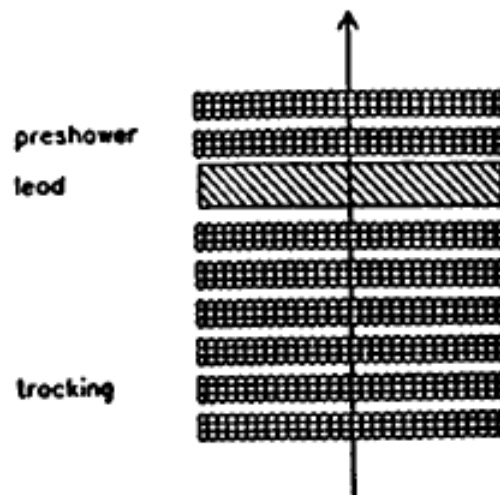
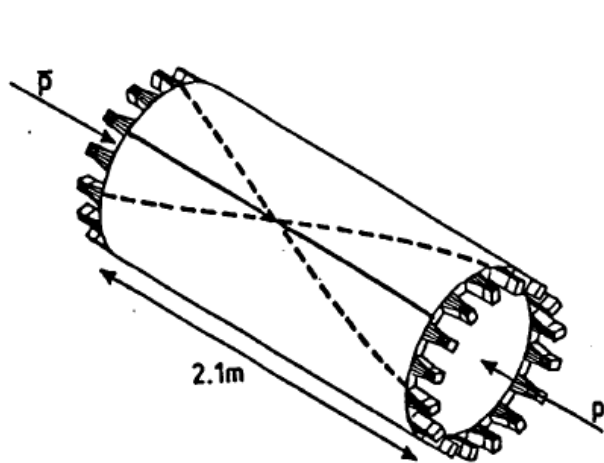

UA2 readout system

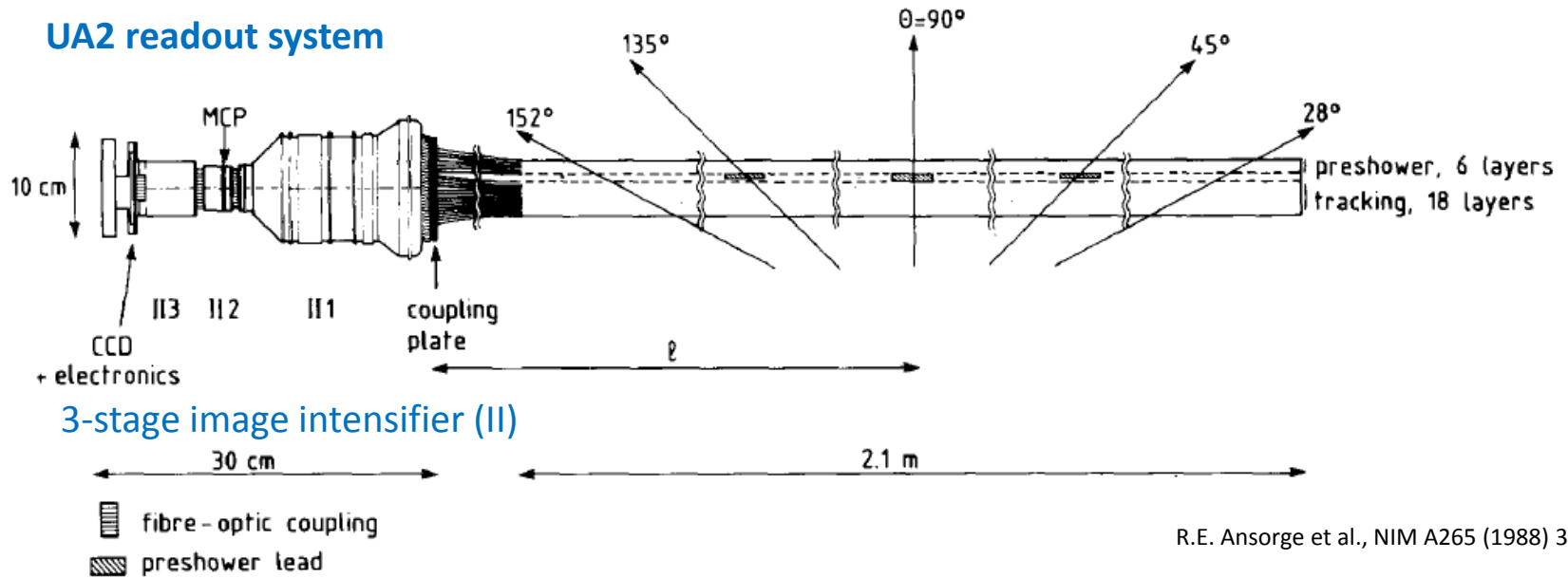

R.E. Ansorge et al., NIM A265 (1988) 33-49

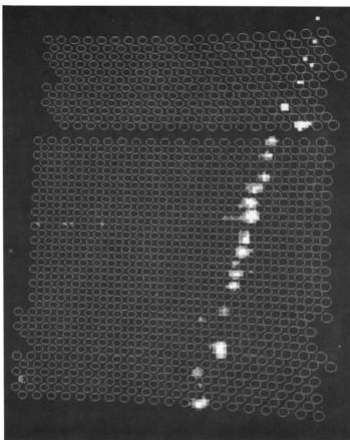

CCD image (circles show calculated fibre positions)

Performance

- 2.8 p.e. per fibre (1mm)
- Single fibre efficiency: >91%
- $\sigma_{\text{hit}} = 0.35 \text{ mm}$, $\sigma_{\text{track}} = 0.2 \text{ mm}$
- Readout time $\sim 10 \text{ ms}$

CHORUS

Annis P, et al.
NIM A 367
 (1995) 367

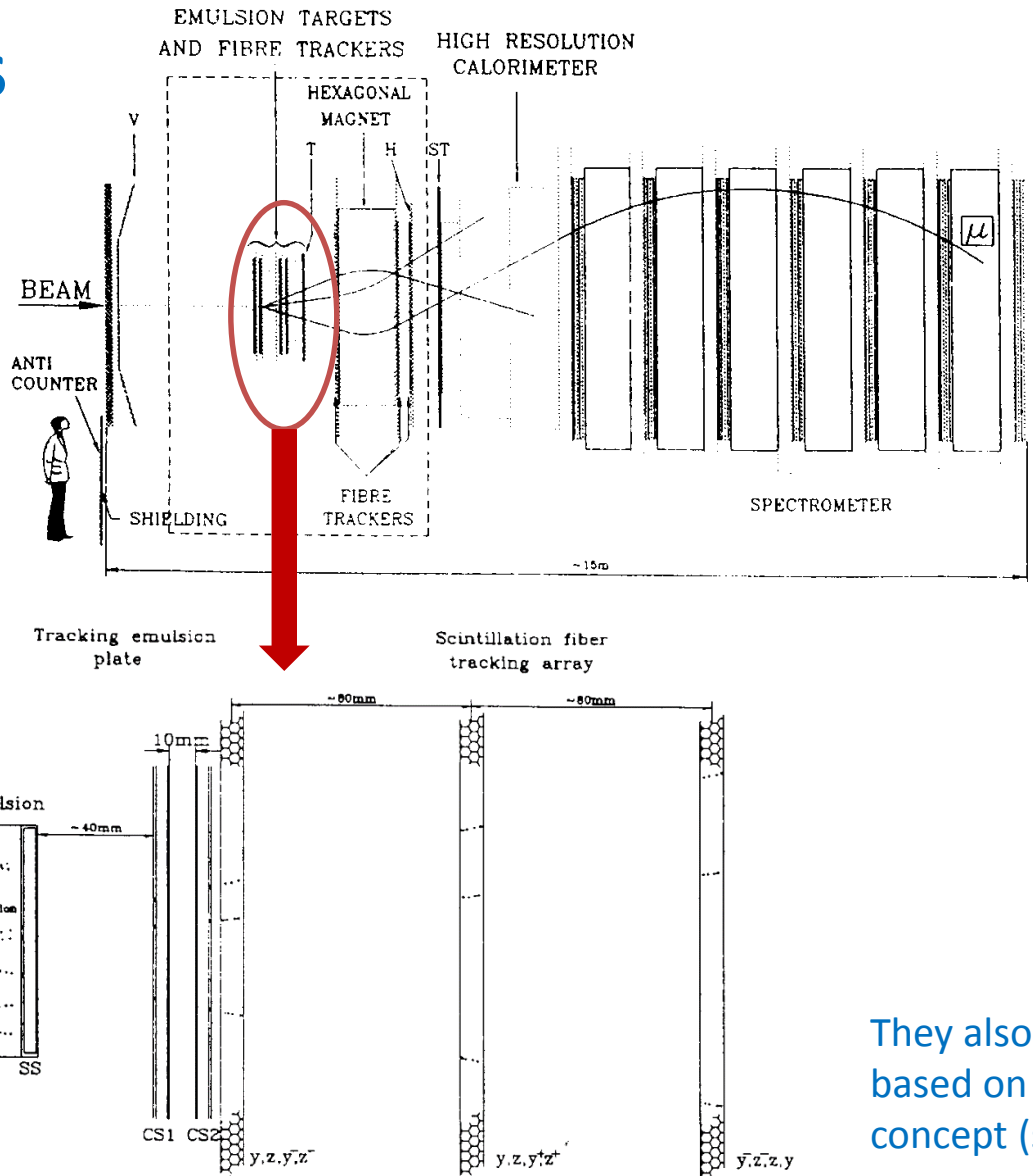

- 10^6 scintillating fibres of $\varnothing 500 \mu\text{m}$
- 58 image-intensifier chains + CCD,
- similar to UA2.

The scintillating fibre-tracking layers provide pre-localisation of the regions to be scanned in the emulsion.

They also tested a micro-vertex tracker based on the liquid-in-capillary concept (see photo on slide 14).

DØ

The upgraded DØ detector comprises a 80,000-channel central fiber tracker (CFT).

V.M. Abazov et al, A 565 (2006) 463–537

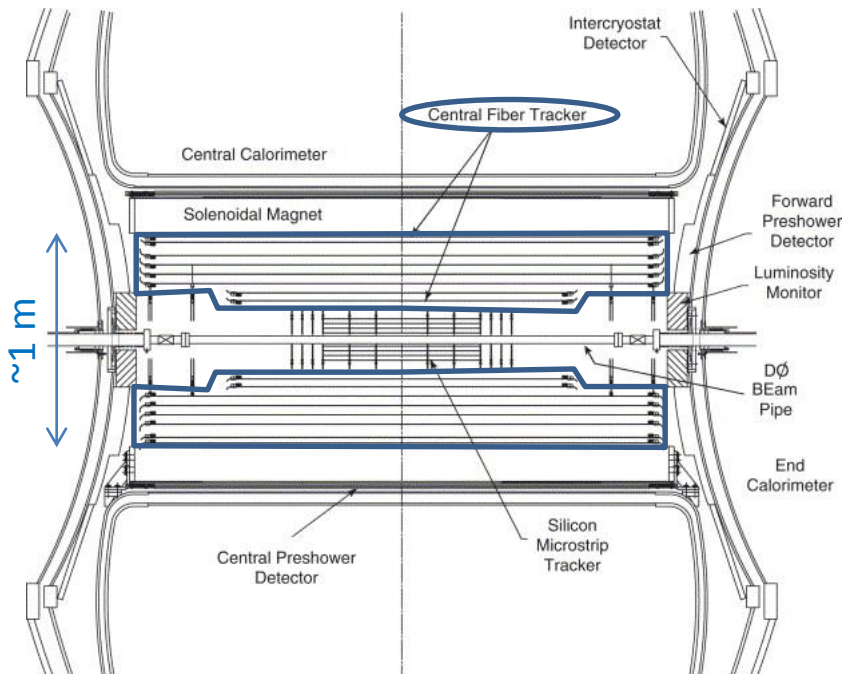

Ø 835 µm fibres are arranged in 'Doublet' structure

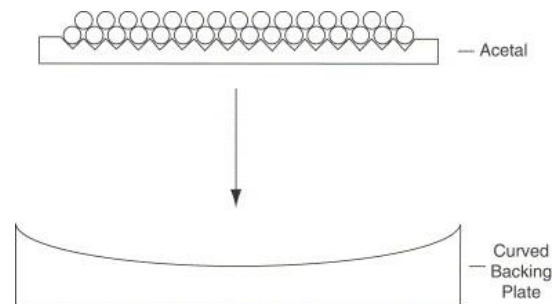

- 8 concentric layers (axial + stereo)
- $L_{\text{fibre}} \sim 2 \text{ m} + O(10)\text{m}$ clear waveguide
- Total = 200 km of scintillating and 800 km of clear fibres

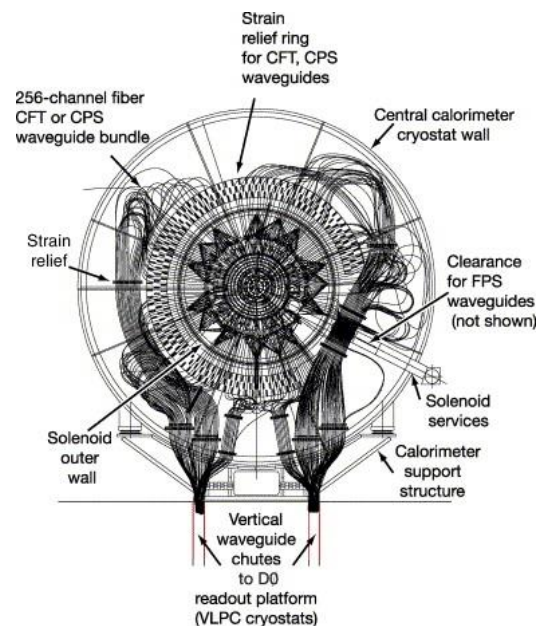

Very innovative readout in D0: Visible Light Photon Counters (VLPC)

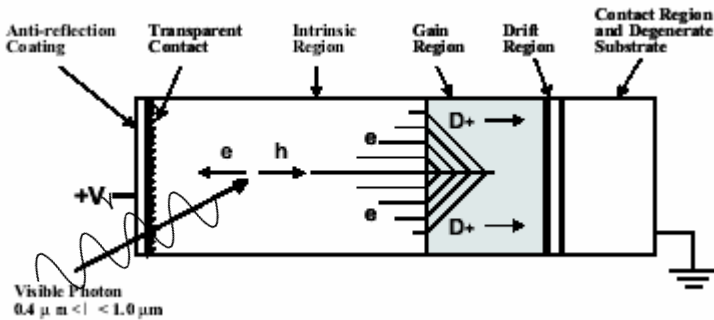

Si:As avalanche photodiode
 Very high QE: ~ 75%
 High gain: ~40.000
 ! Needs to be operated at T=9K!

LED calibration spectrum

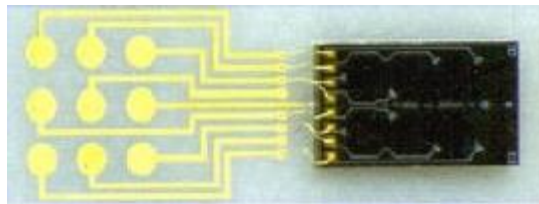
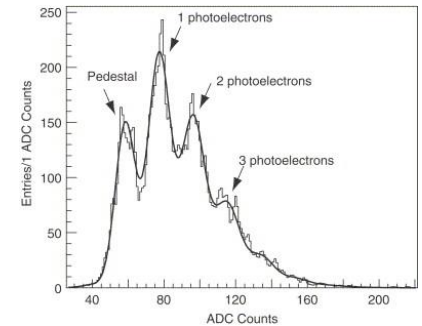

D0 used chips with 8 VLPCs (Ø 1mm).
 128 chips fit in a cassette

Performance (partly from test stand)

B. Baumbaugh et al. IEEE TNS 43, NO. 3, JUNE 1996

- Yield: ~10 pe / fibre
- Hit efficiency: 99.5%
- Doublet hit resolution: 100 μm
- Fast readout: CFT contributes to the L1 trigger (every 132 ns)

Same technology is also used in the MICE experiment <http://mice.iit.edu/>

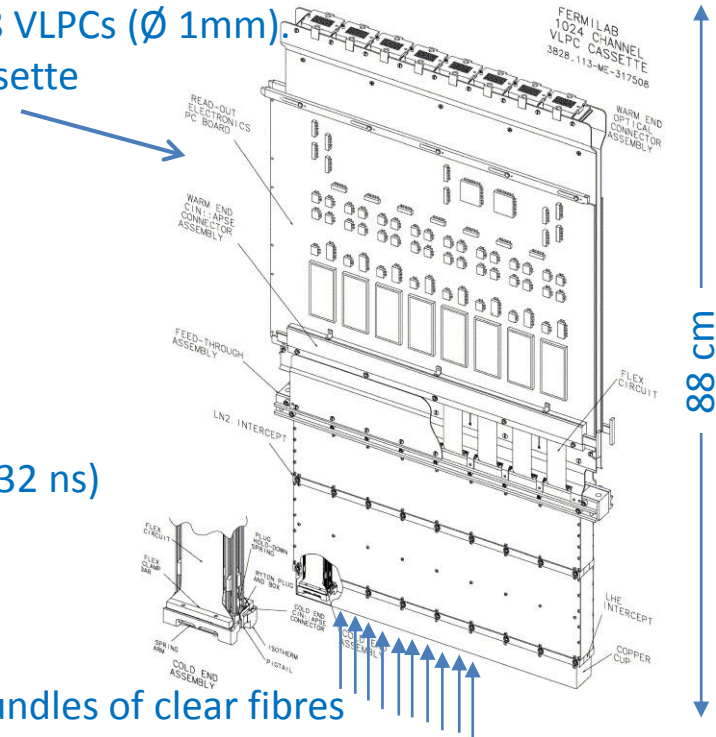

Bundles of clear fibres

Forward detector in Roman Pots for luminosity and $\sigma_{\text{tot}}(\text{pp})$ measurement

4 RP stations are located at ± 240 m from ATLAS in LHC tunnel

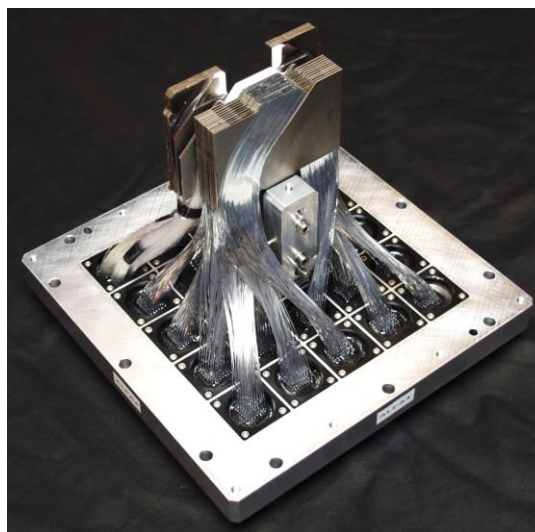
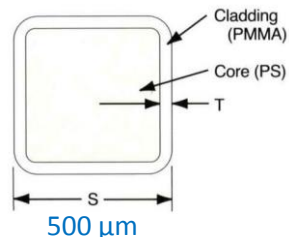
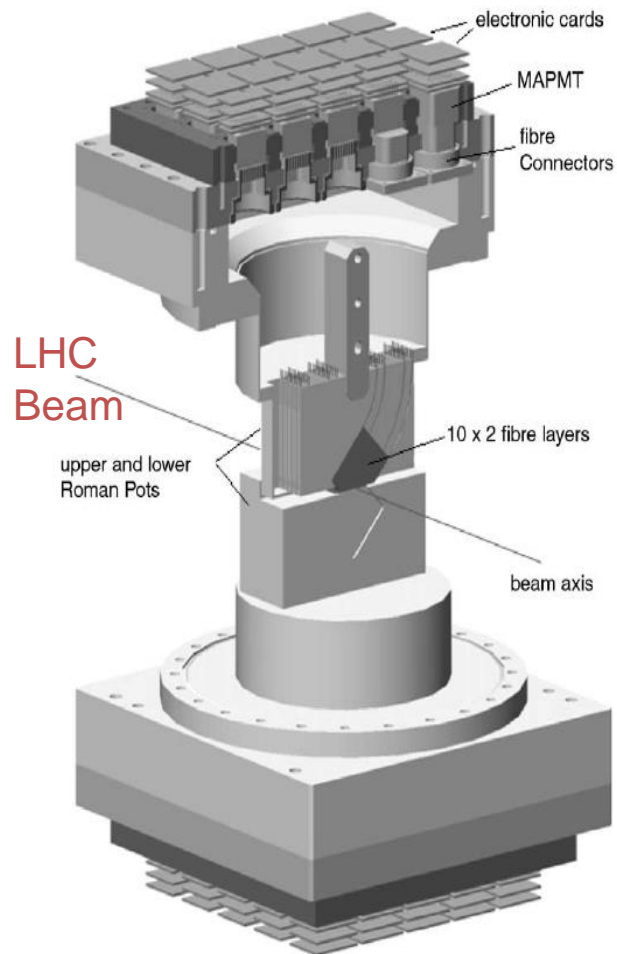

- Total $\sim 11,000$ fibres, $500 \mu\text{m}$ squared, ~ 35 cm long, aluminized for reduced cross-talk.
- UV geometry with 2×10 staggered layers. Active area is only about $3 \times 3 \text{ cm}^2$.
- Readout (at 40 MHz) by 184 Multi-anode (64 ch.) PMTs.

Performance:

- Yield: $\sim 4 \text{ pe / fibre}$
- Track resolution: $\sim 25 \mu\text{m}$

A short recap of SiPM technology

Silicon Photomultipliers (SiPM) - What makes them so attractive for SciFi ?

A photodetector for reading the scintillation light from a fibre requires

	Image intens. CCD	(MA)PMT	SiPM	
High sensitivity (PDE)	0	0	+	~ 40%
High charge amplification	+	+	+	~ 10 ⁷
High speed (multi-MHz)	-	+	+	
Small size	0	-	+	~ mm ²
Low cost (per channel)	-	-	+	few CHF
Immunity to magnetic field	-	-	+	
Radiation tolerant	0	0	-	

PIN photodiode

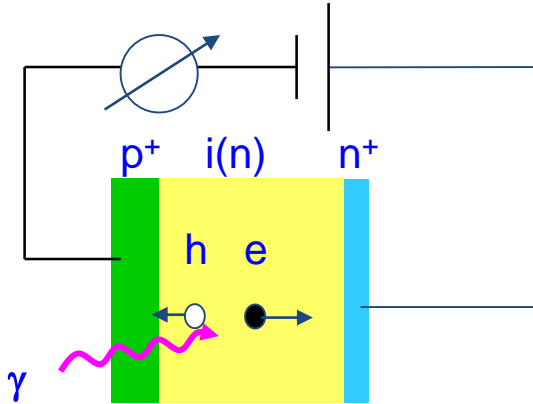

- High QE (~80%)
- $U_{\text{bias}} = \text{small (or even 0)}$
- No charge gain ($G=1$)
- 1 photon \rightarrow 0 or 1 electron
- Can't detect single/few photons

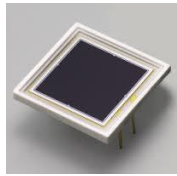

$A = 1\text{cm}^2$



Avalanche Photodiode (APD)

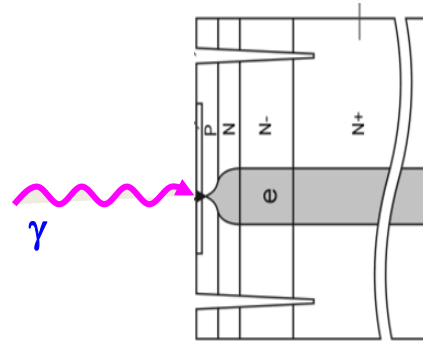

- High QE (~80%)
- $U_{\text{bias}} = \text{few } 100\text{ V}$
- 'small' avalanche, self terminating
- Charge gain $G \sim \text{few } 100$
- Can't detect single/few photons

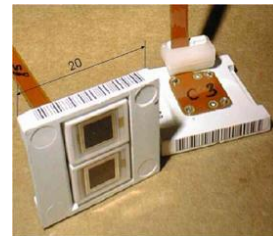

CMS ECAL

SiPM

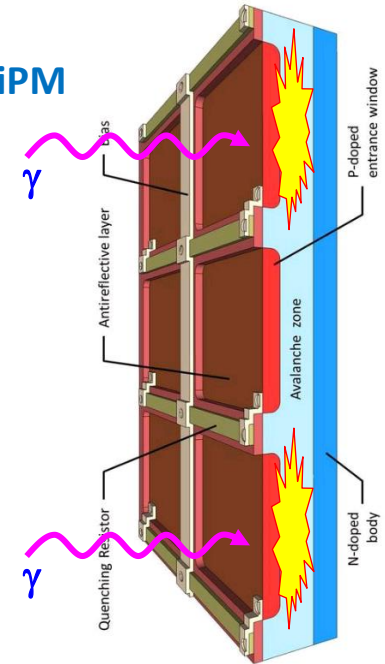

Multi-pixel array of APD

- operated in Geiger mode, i.e. above break down
- $G \sim 10^6 - 10^7$
- forced quenching
- Every pixel is just a binary detector ($0/\geq 1$)
- Parallel connection of all pixels gives a quasi-analog detector

100 – several 10000 pix / mm²

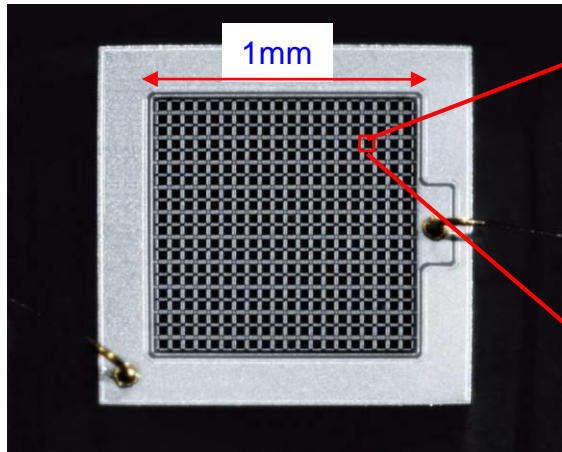

Sizes up to 6x6 mm² now standard.

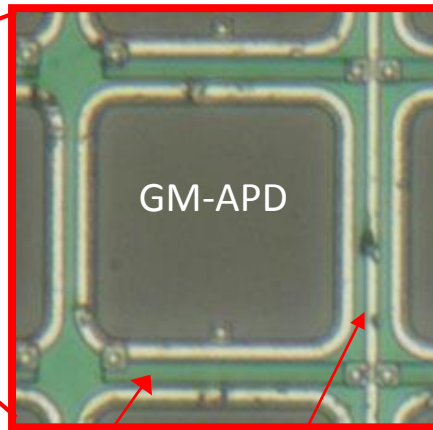

Only part of surface is photosensitive!

Photon detection efficiency

$$PDE = QE \cdot \epsilon_{geom} \cdot \epsilon_{avalanche}$$

=f(OV)

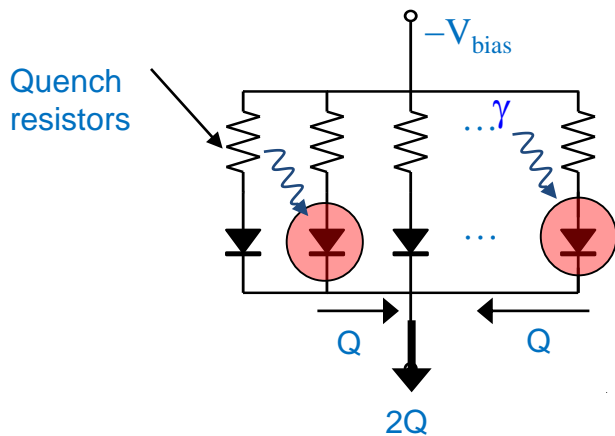

quench resistor bias bus

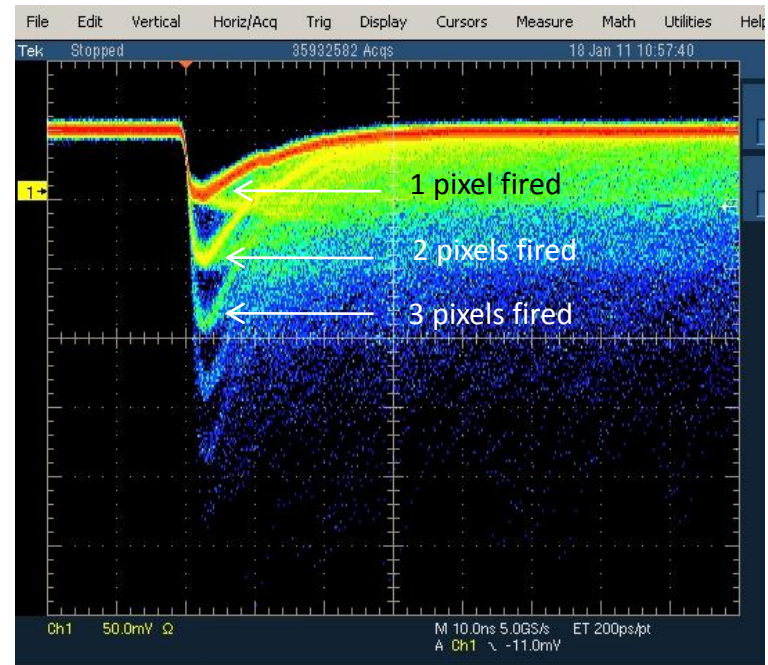

- 1 GM-APD is a binary device.
- The operation of many GM-APDs in parallel leads to a quasi-analog detector with photon counting properties.

The LHCb SciFi Tracker

General layout of the detector geometry:

3 stations with 4 planes each X-U-V-X (like the OT)

Requirements:

- $\sigma_x < 100\mu\text{m}$ (bending plane)
- Low mass, 1% X_0 per layer
- Readout every 25 ns
- Radiation tolerant up to 35 kGy and 10^{12} n/cm²

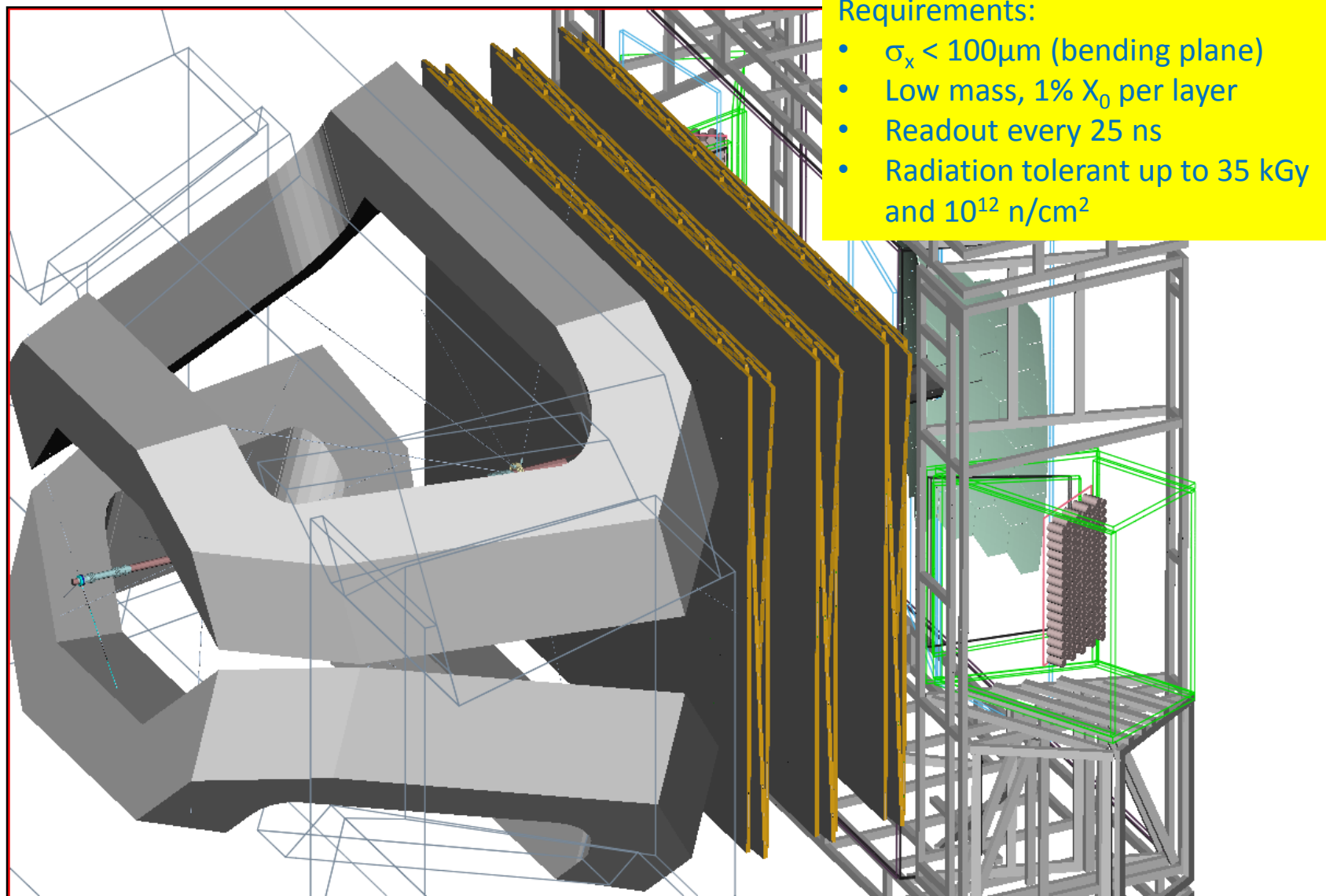

SciFi in numbers

Fibre mat

↓ × 8

SciFi Module

↓ × 12

Detector Layer

↓ × 4 (stereo angles
0°, +5°, -5°, 0°)

Tracking Station

↓ × 3

Scintillating Fibre Tracker

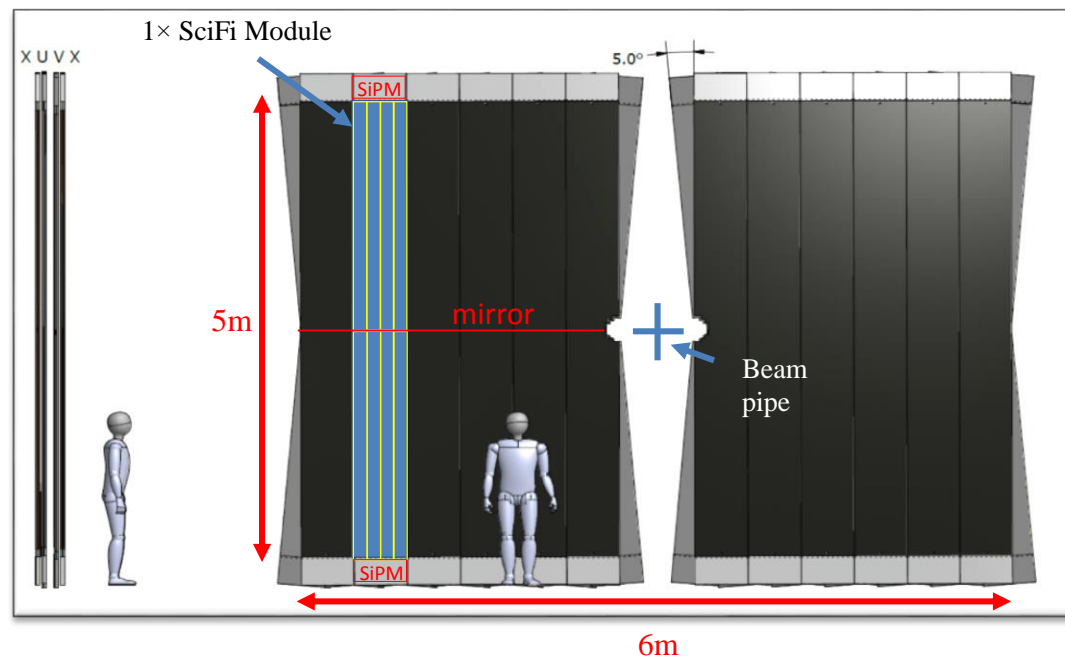

- 1024 mats, 128 modules
- **340 m²** total area
- almost **11,000 km** of fibre
- **4096 SiPM arrays** → **525'000 SiPM channels**

QA on scintillating fibres (11'000 km, 880 spools)

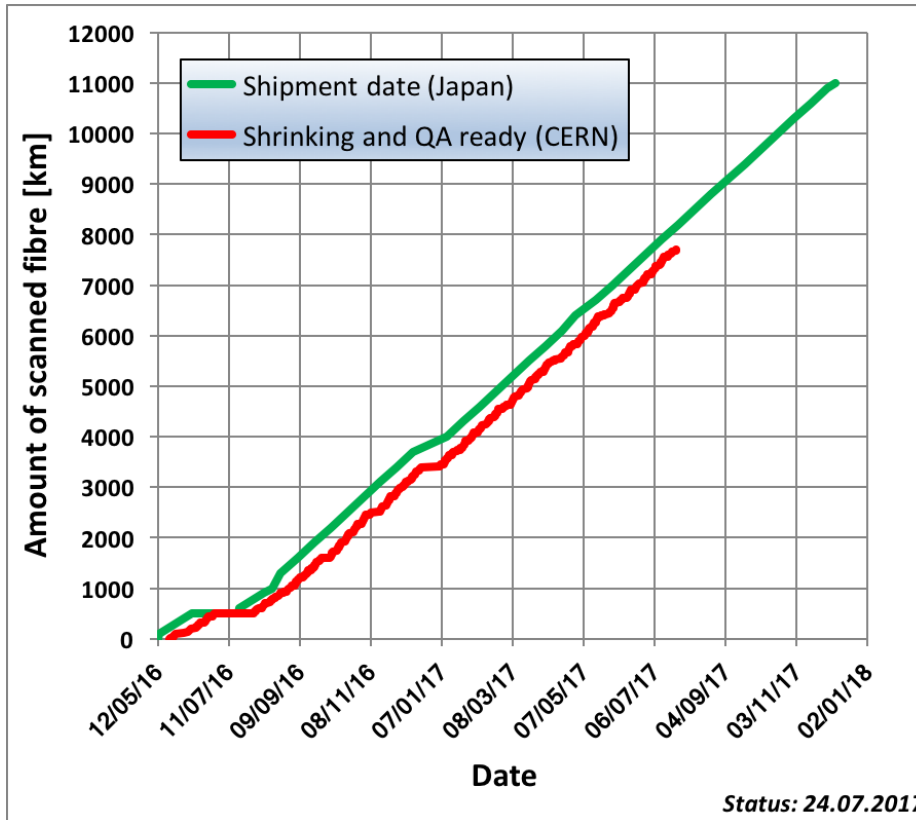

- Every mm of fibre is scanned for diameter anomalies (bumps)
- Big bumps ($\Delta D > 100 \mu\text{m}$) are shrunk / removed.
- Every spool is characterised in terms of attenuation length and scintillation light yield.
- A fraction of spools is checked for radiation hardness, decay time, bendability
- Significant contribution from CBPF: A.B.R. Cavalcante 2014 – 2016 (PhD 08/2017)

Fibre mat & module production

Ø80 cm wheel with fine thread ($p=0.275$ mm)

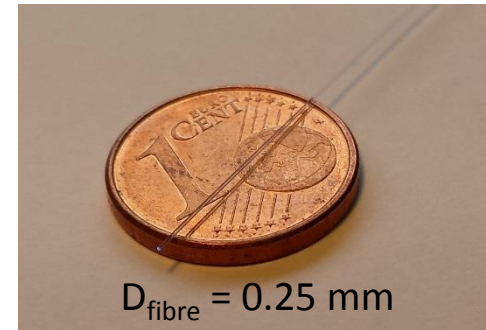
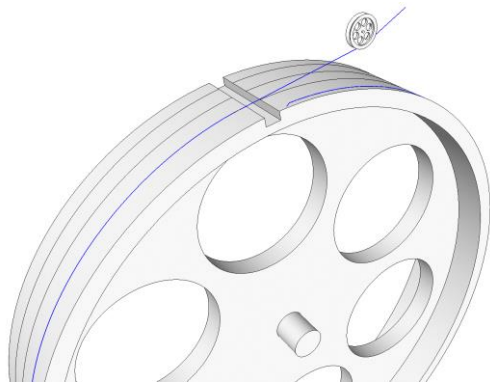

6 layers
+ epoxy
glue

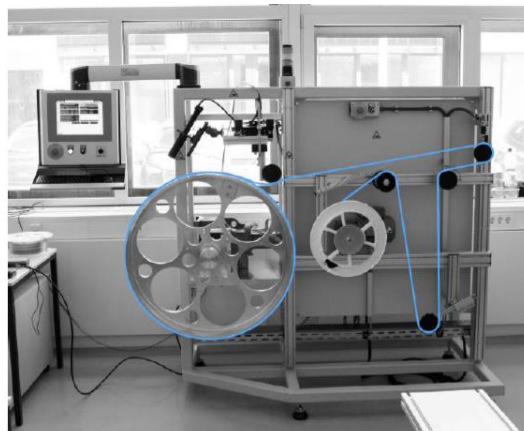
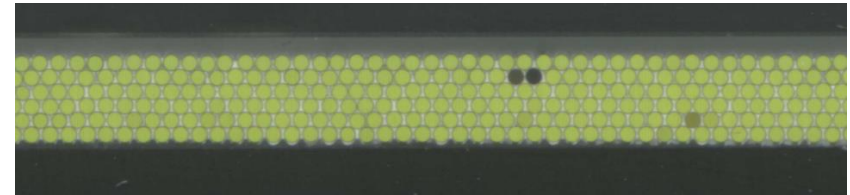

Winding machine, produced in industry

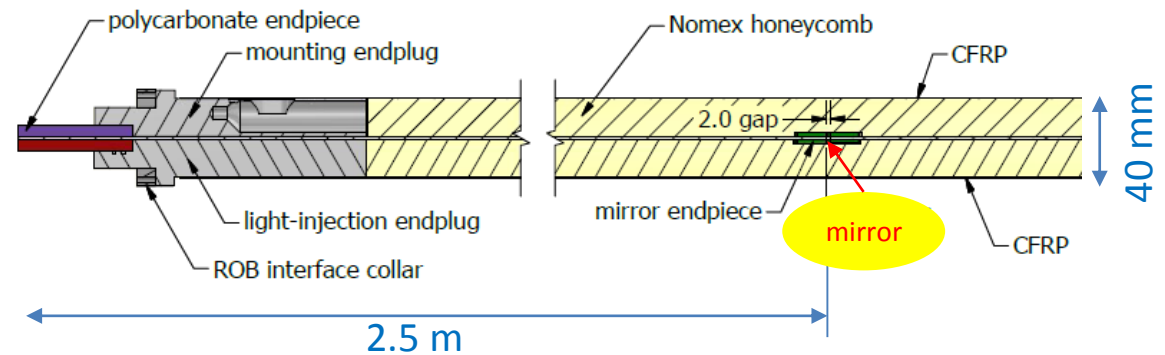

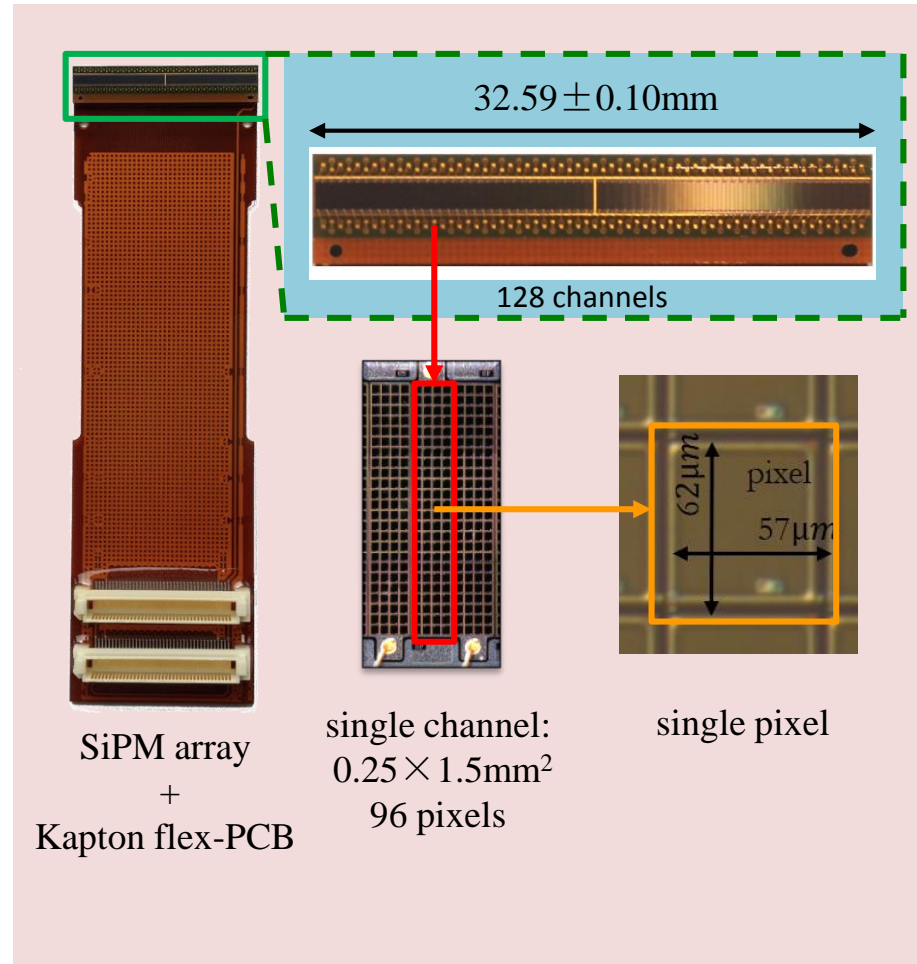
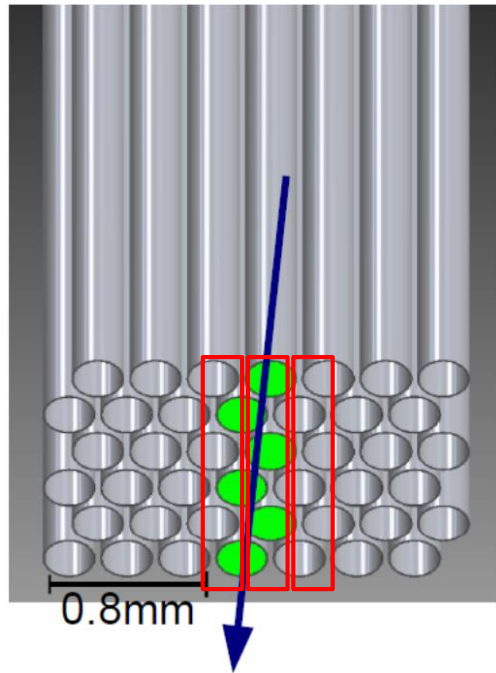

Principle of electronics

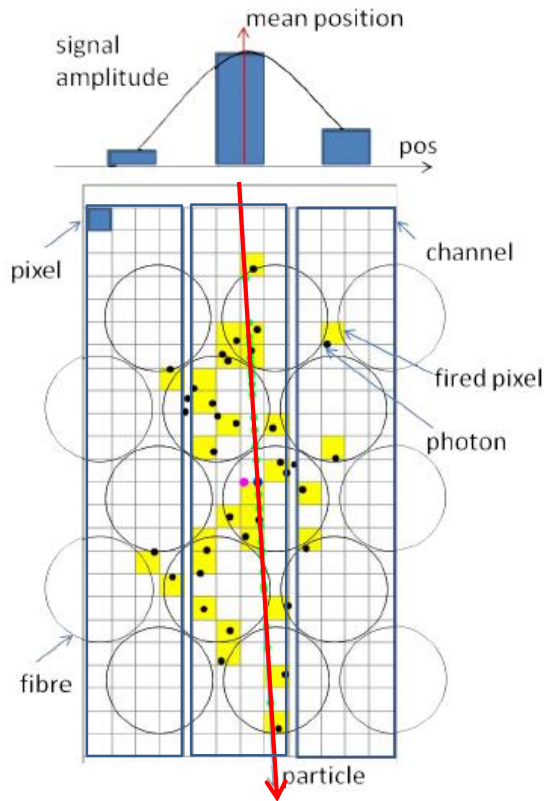

Achieved in test beam:
 $\sigma_x \leq 84 \mu\text{m}$

- Hit fibres form clusters of 2-3 SiPM channels
- Analog centroiding would give optimum spatial resolution.
- Signal per channel up to ~ 20 pe \rightarrow require 6 bits resolution.
- Remember: 525 k channels \times 40 MHz readout \times 6 bits = 126 Tb/s \rightarrow Not affordable
- **Second best solution: a 3-thresholds binary readout**

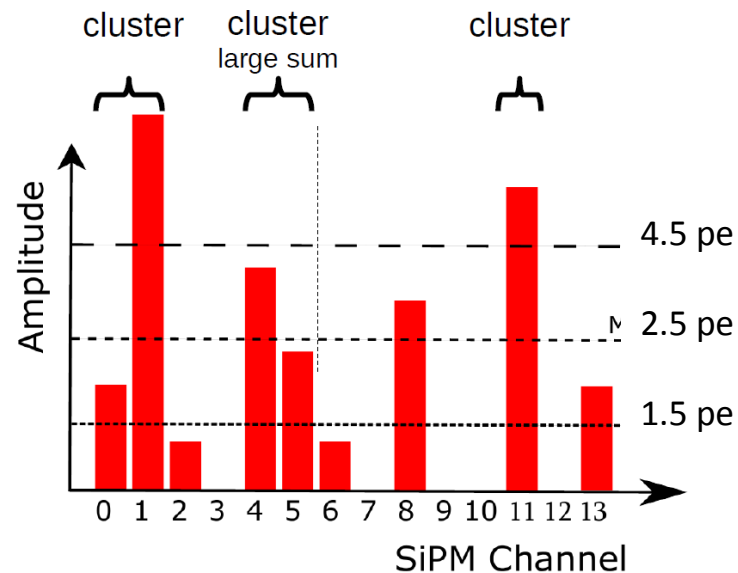

3 thresholds
 = 2 bits

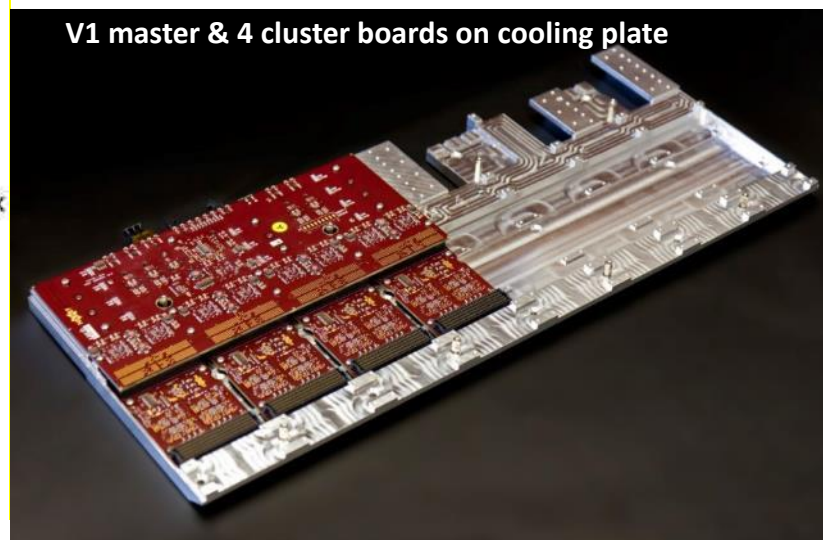
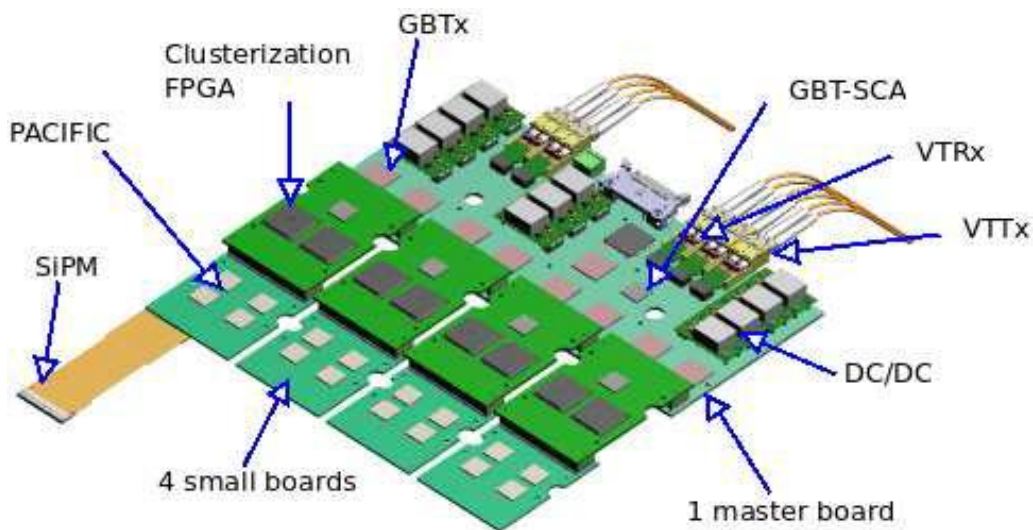
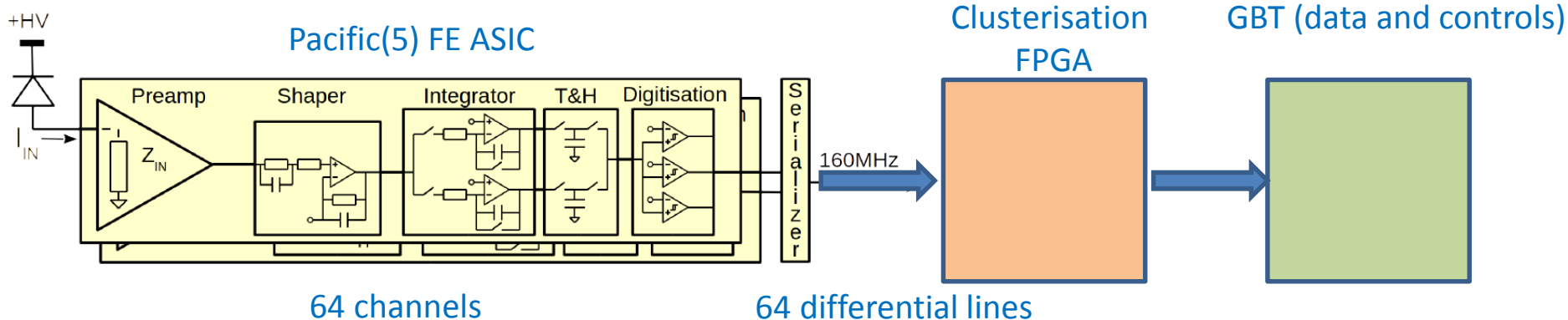

Significant contribution from CBPF: PACIFIC emulator set-up (8x256 channels). A. Massafferri et al.

What makes LHCb SciFi challenging (= interesting)?

- Radiation
- Large size
- High precision
- Complex integration



LHCb Radiation Environment

Ionization dose:
35 kGy in hottest region

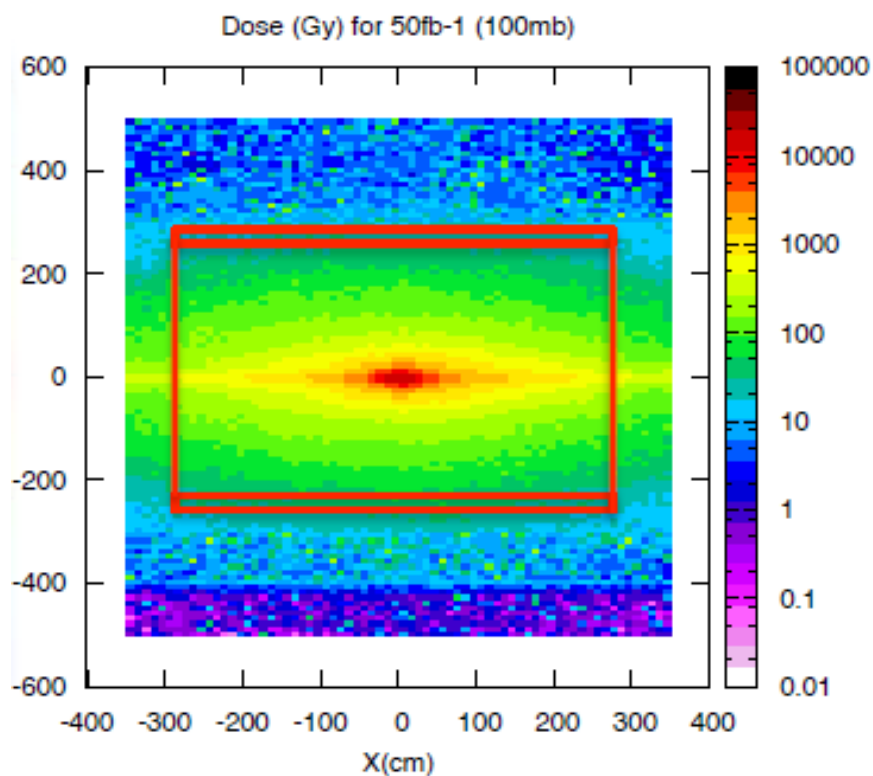

decrease of fibre transparency

Neutron fluence
at SiPMs: $6 \times 10^{11} n_{eq} / cm^2$

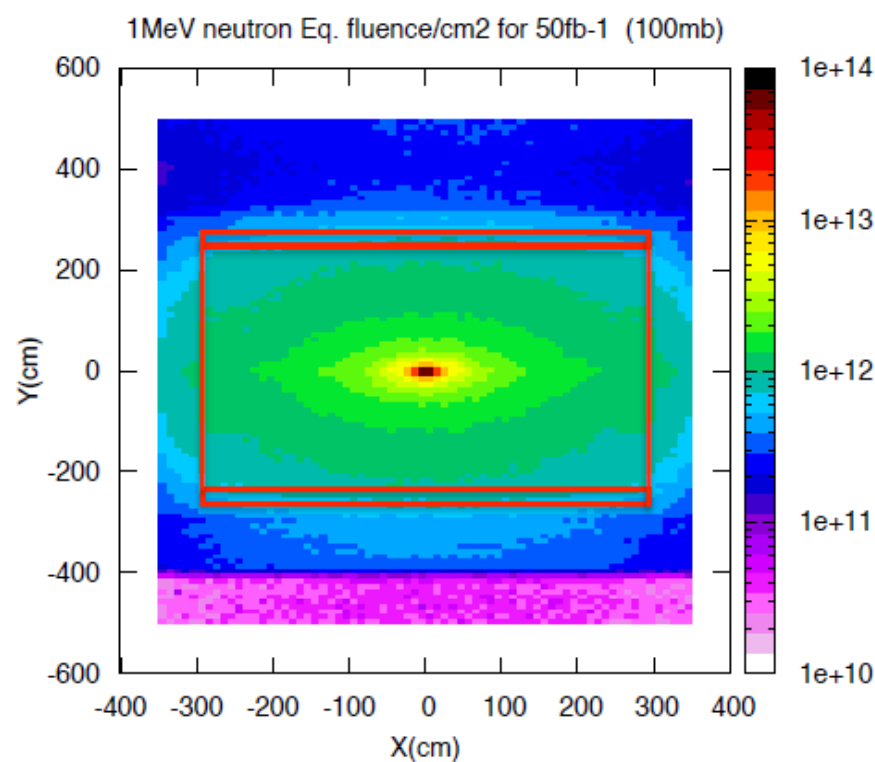

Increase of SiPM dark noise

Example: LHCb fibre irradiation test (CERN PS, 2012)

- 3 m long SCSF-78 fibres (\varnothing 0.25 mm), embedded in glue (EPOTEK H301-2)
- irradiated at CERN PS with 24 GeV protons (+ background of $5 \cdot 10^{12}$ n/cm²)

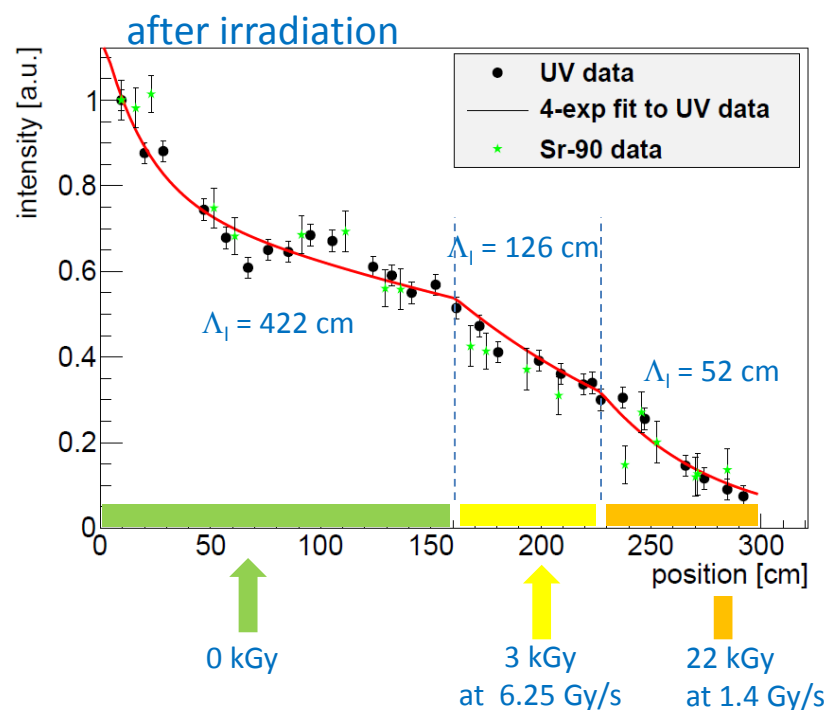
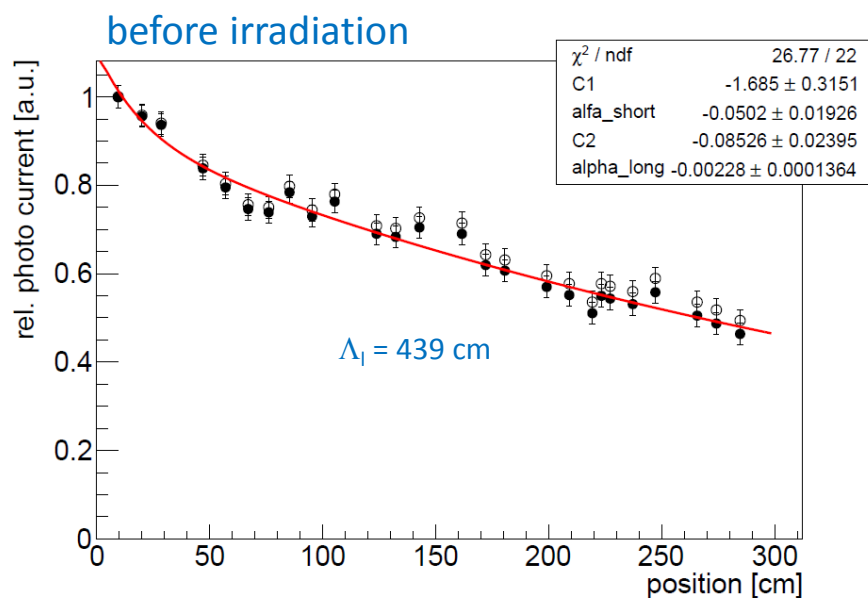

Dose along fibre will be very non-uniform

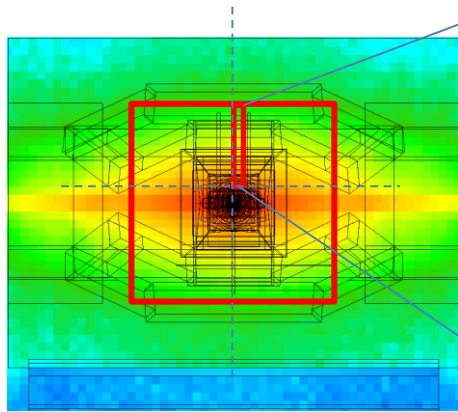

Fluka
M. Karacson

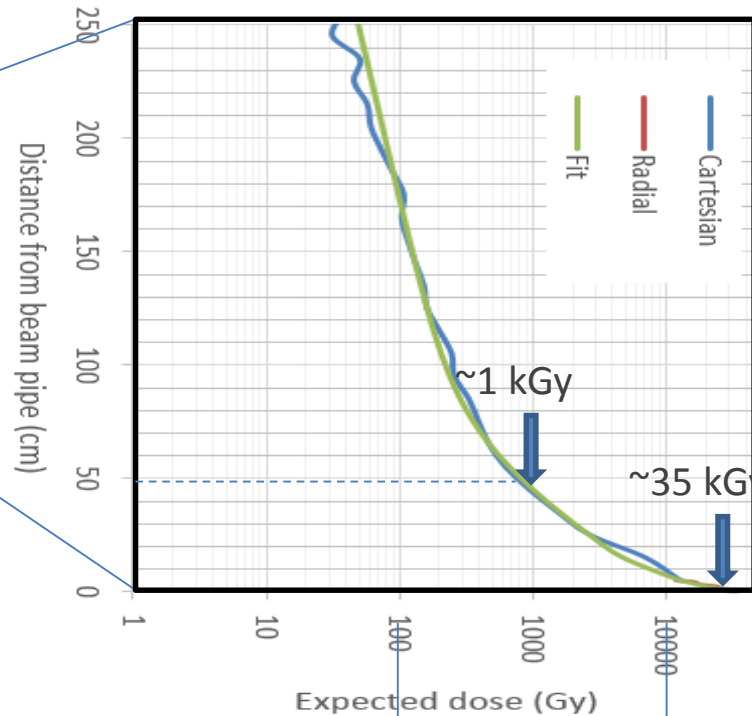

SiPM position

beampipe level

Attenuation length Λ

Attenuation factor $\alpha = 1/\Lambda$

$$\alpha = \alpha_0 + \alpha_{irr}$$

$$\alpha_{irr} \sim k \cdot D$$

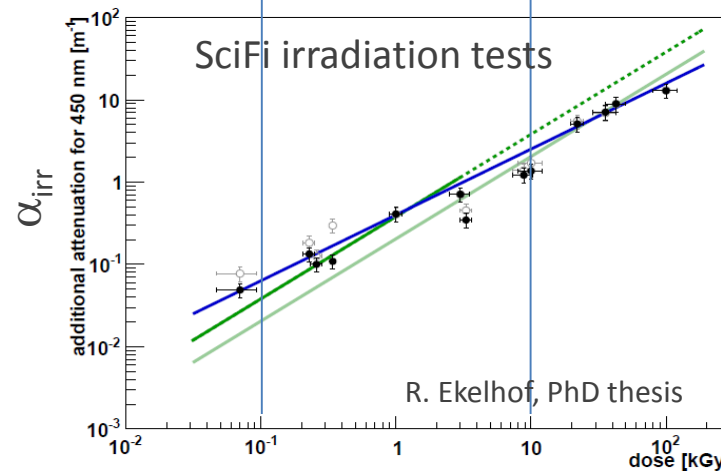

Many radiation test
→ reasonably good
understanding of
radiation damage
over full dose
range.

R. Ekelhof, PhD thesis

We irradiated two mirrored SciFi mats in the PS Irrad facility at CERN to the expected steep dose profile. Only a 25 mm wide band along the mat was irradiated.

From previous results, the expected signal loss at the mirror end of the mat was 40%.

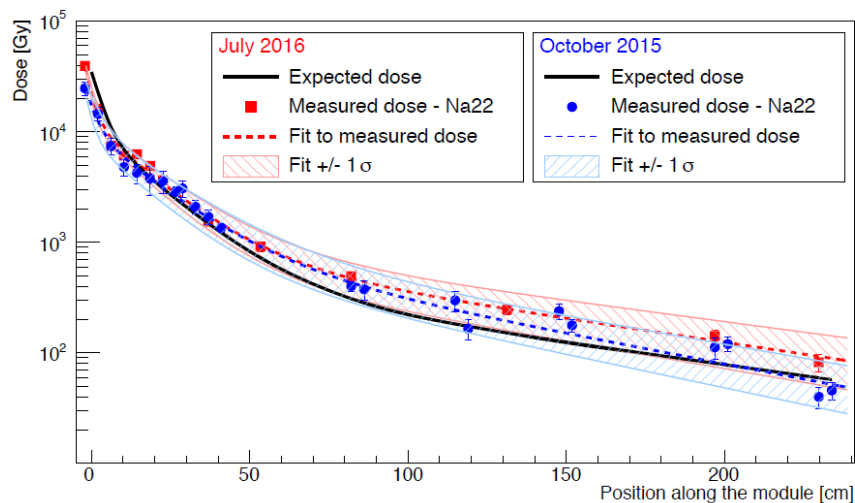

Scan across the mat (13 cm), at 2 cm from mirror

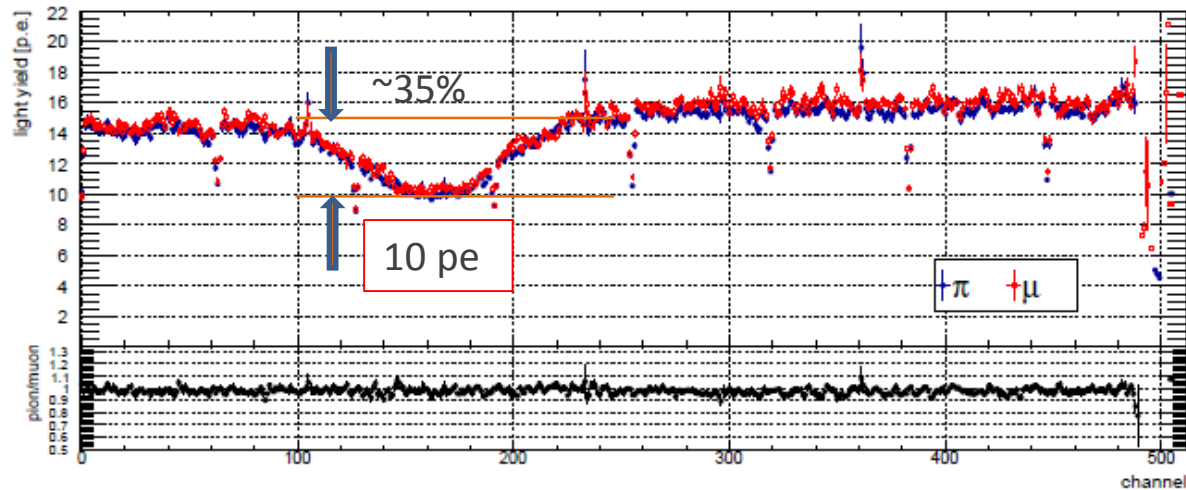

(* the ultimate test would be to irradiate at the correct (non-accelerated) dose rate, which would have taken 5 years. However, we have so far no indications that rate matters).

- As in every Si device, neutrons damage the Si lattice → leakage current.
- In a SiPM the main effect is the increase of the dark count rate (DCR), linearly with the neutron fluence: $DCR = a \cdot \Phi_n$,
- At room temperature, DCR can reach GHz per SiPM channel
- Neutrons fluence is about the same for all SiPMs → All SiPMs are equally affected.

Dark counts from a single channel of an irradiated SiPM detectors, operated at $T = -40^\circ\text{C}$

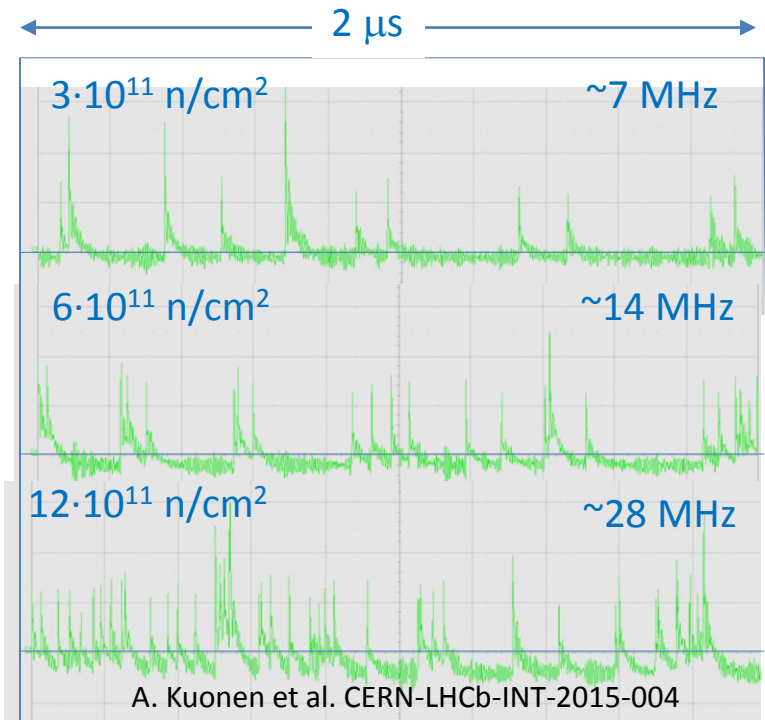

- Problem: noise hits have same amplitude as 1 pe signal hits. They can combine/pile up to signal-like noise clusters. → Noise Cluster Rate (NCR)
- For efficient operation and reconstruction, NCR shall not exceed 50% of the smallest Signal Cluster Rate (SCR), which is 4 MHz.

➤ **Solutions:**

- **Cooling:** Every 10 K reduction halves DCR. $T = -40^{\circ}\text{C}$ gives a factor 64 (2^6) reduction.
- **Clustering.** Noise hits don't form clusters, except accidentally!
- **Optimise SiPM** for low cross-talk and after pulses.
- Use preamp with **short shaping** time.
- **Neutron shielding.**

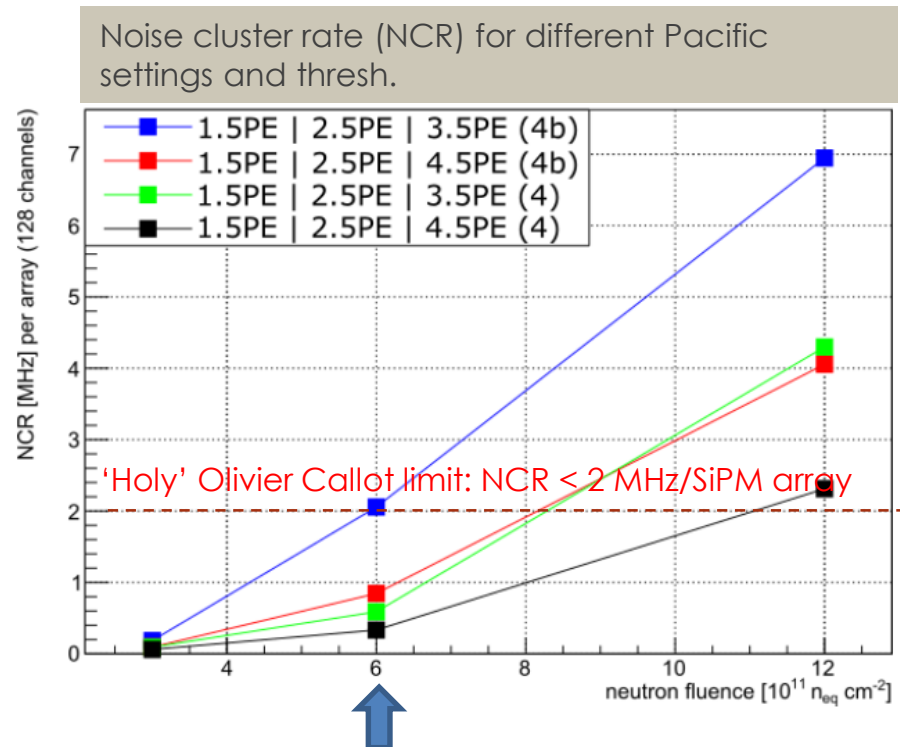

- 2 x 6 C-frames
- Hanging under existing bridge, new rail system needed.
- Precise positioning of 2 x (5)6 modules
- Supply of Novec fluid (@-50C)
- Supply of cooling water
- HV & LV cables
- Signal and control fibres

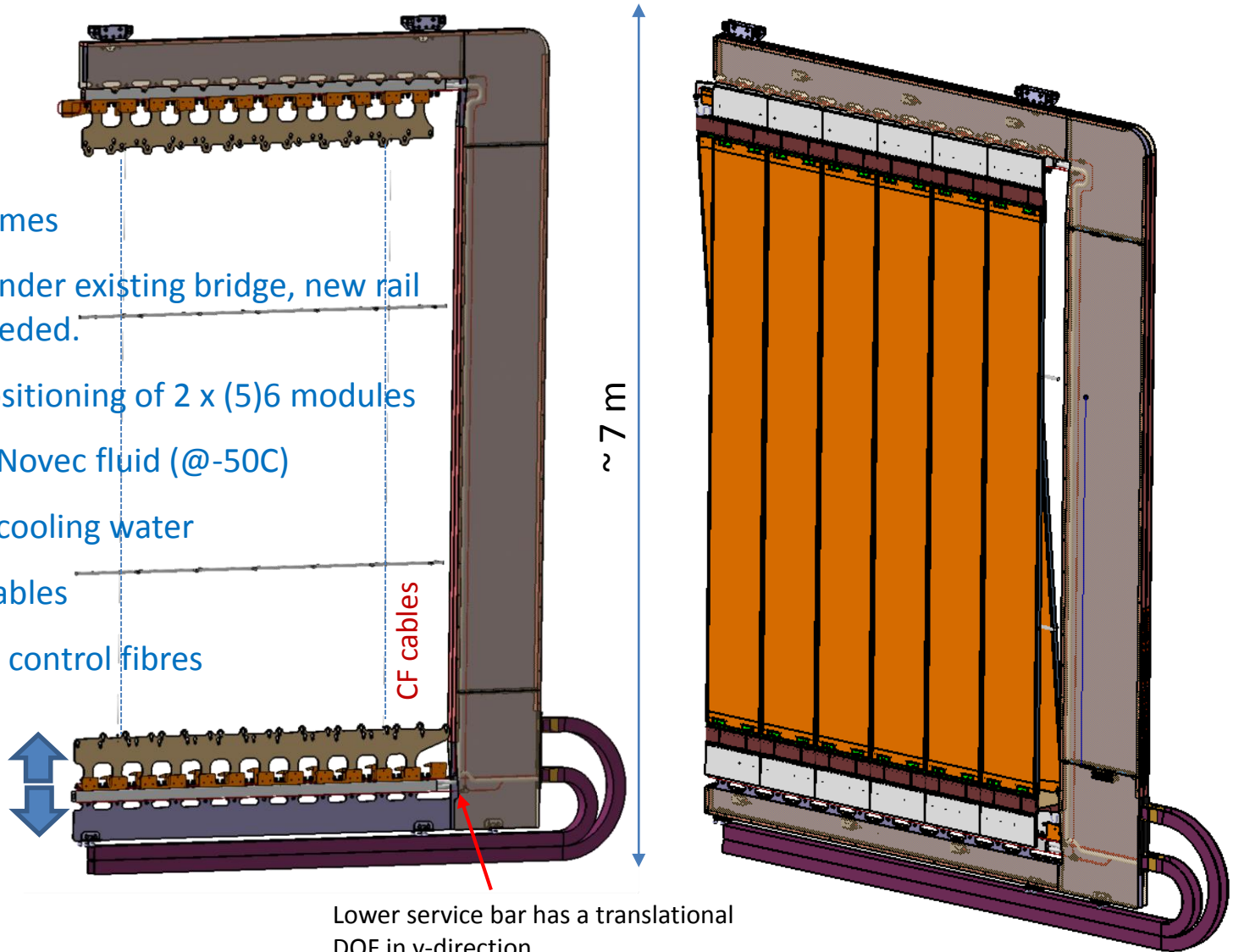

Lower service bar has a translational DOF in y-direction

Very challenging and complex integration

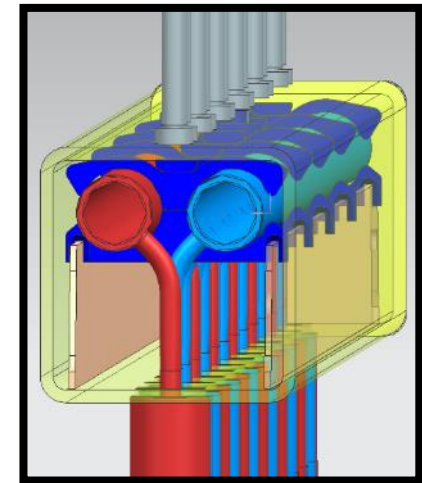
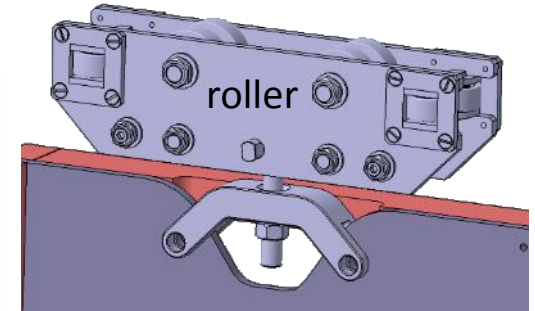
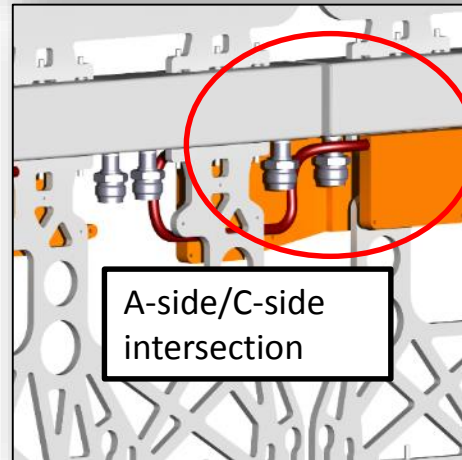
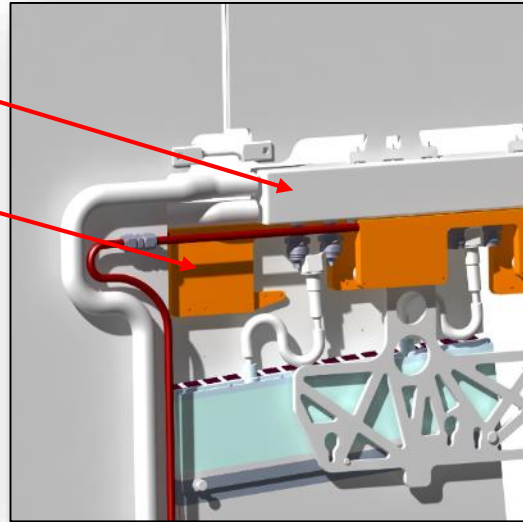
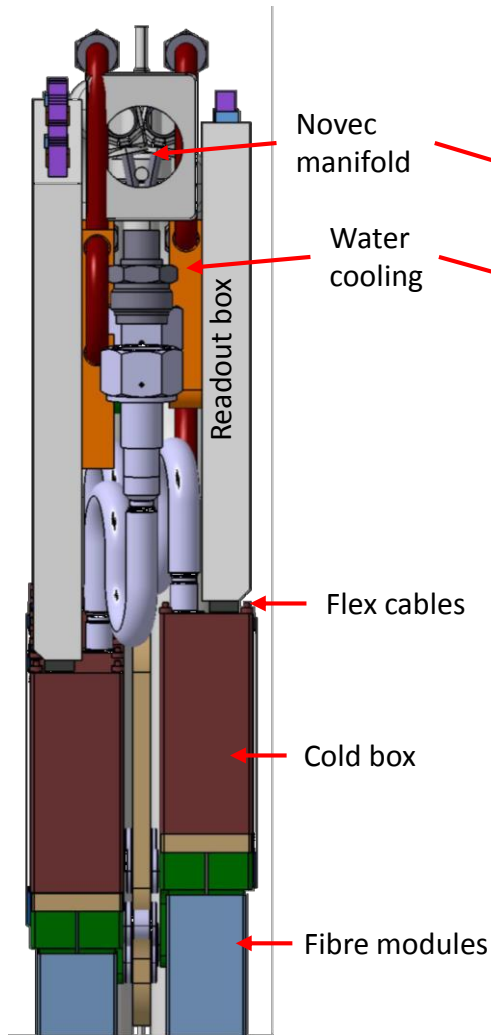

Novec manifold, vacuum insulated

Overall Status of Project

	R&D	proto	pre-series	series	On schedule		
Fibres					75%	<input checked="" type="checkbox"/>	
Mats					45%	<input type="checkbox"/> → <input checked="" type="checkbox"/>	catching up
Modules					25%	<input type="checkbox"/> → <input checked="" type="checkbox"/>	catching up
SiPM					ordered	<input checked="" type="checkbox"/>	
Flex cable					ordered	<input checked="" type="checkbox"/>	
Cold box						<input checked="" type="checkbox"/> → <input type="checkbox"/>	still some issues
Pacific ASIC					Fully operational	<input type="checkbox"/>	tight
FEE						<input type="checkbox"/>	tight
C-frames						<input checked="" type="checkbox"/> → <input type="checkbox"/>	tight

No but some tension in the planning.

LHCb gets ready for a SciFi upgrade

by *Kate Kahle*

CERN weekly bulletin (30/08/2017)



Each of the four boxes houses five detector modules. 128 modules will make up the new scintillating fibre (SciFi) tracker, part of the major upgrade of the LHCb detector (Image: Christian Joram/ CERN)

The very first detector elements of the **LHCb** upgrade, early pieces of the scintillating fibre (SciFi) tracker, have arrived at CERN. Four boxes housing the first 20 of 128 modules were

Summary and Outlook

- Thanks to **Silicon Photomultipliers (SiPM)**, there is new interest in **scintillating fibres**. One can build **fast** and **light tracking detectors**
- **LHCb SciFi tracker will be the largest and fastest fibre tracker ever built**
- Radiation levels pose major problems, but the chosen design is expected to cope with them (in Runs 3 & 4, 50 fb^{-1})
- The detector construction is in an advanced state. The schedule is tense but there is (justified) hope that we'll be ready for installation in autumn 2019.
- Not covered in this talk but perhaps of interest to the younger generation: **A further LHCb upgrade (LS4, 2030)** to 2×10^{35} and 300 fb^{-1} would require a modified SciFi and to complement it with an Si-based Inner Tracker, for $R \sim 1\text{-}1.5$ m around beam pipe.

SciFi Tracker: ~20 participating institutes

- Brazil (CBPF)
- China (Tsinghua)
- France (LPC, LAL, LPNHE)
- Germany (Aachen, Dortmund, Heidelberg, Rostock)
- Netherlands (Nikhef)
- Poland (Warsaw)
- Russia (PNPI, ITEP, INR, IHEP, NRC KI)
- Spain (Barcelona, Valencia)
- Switzerland (CERN, EPFL)



RWTH AACHEN
UNIVERSITY



unwinding spool tensioner 50 g cleaner LN 3015 AccuScan 6400 cladding Test

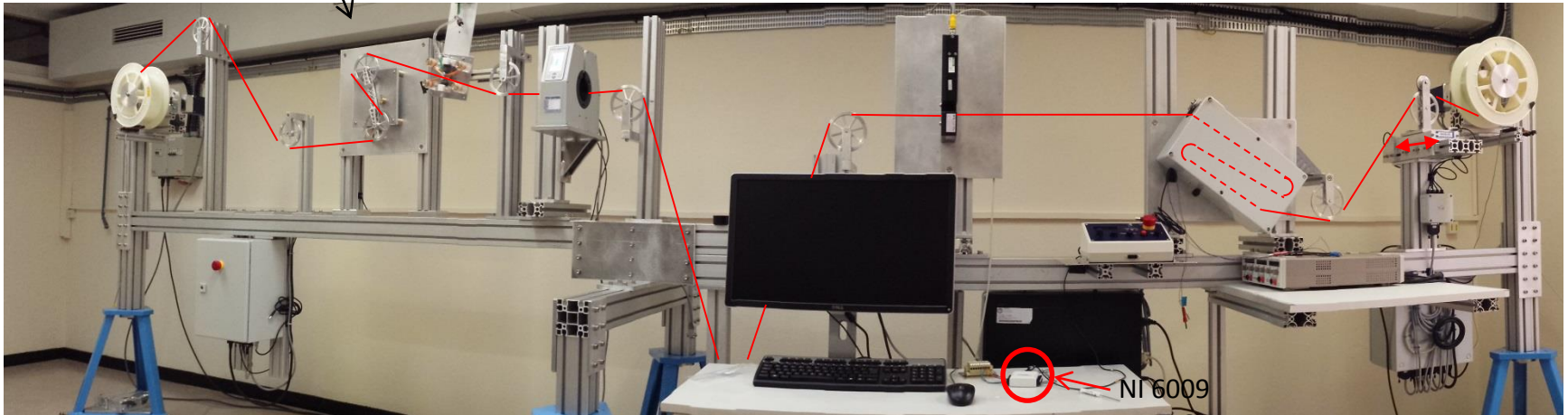

←————— 6 m —————→

CERN (built together with Aachen), which allows to scan fibres with 40 μm step size and $<1 \mu\text{m}$ resolution. A 12.5 km fibre spool can be scanned in ~ 3.5 hours.

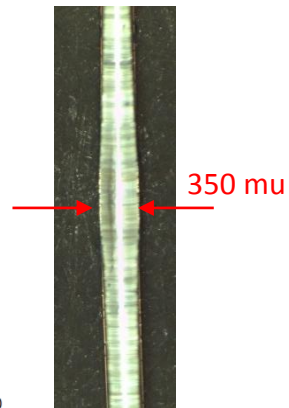
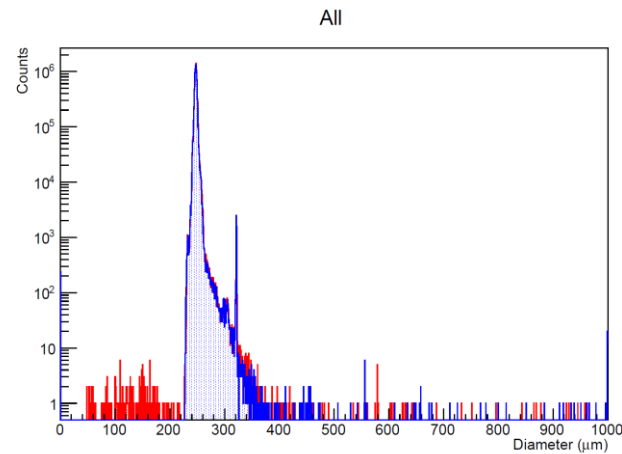
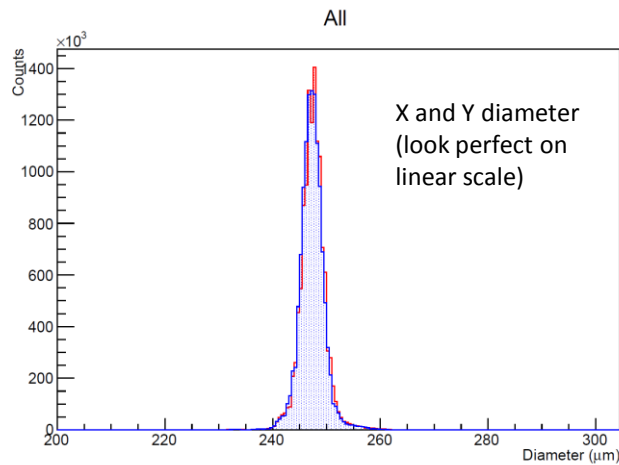

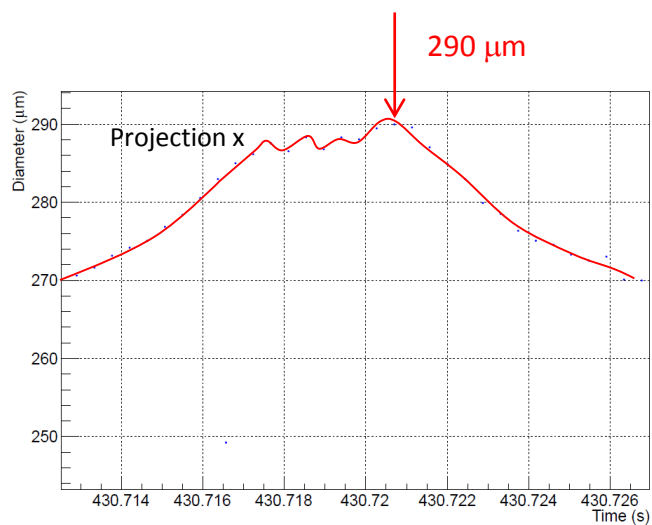

Projection 1 ($\sim x$)

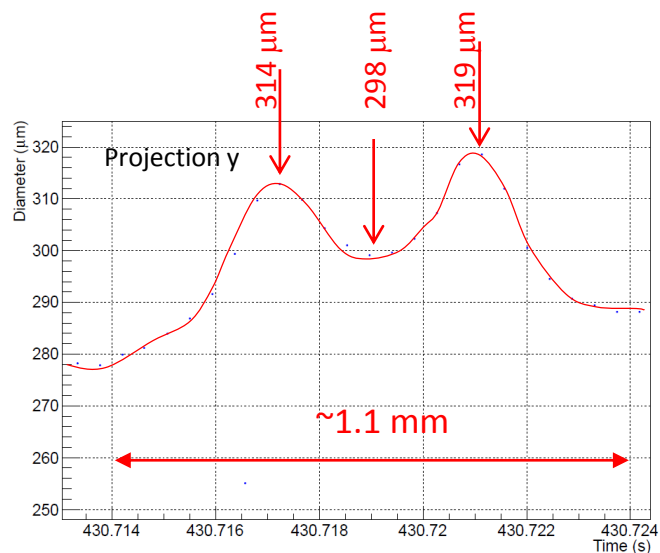
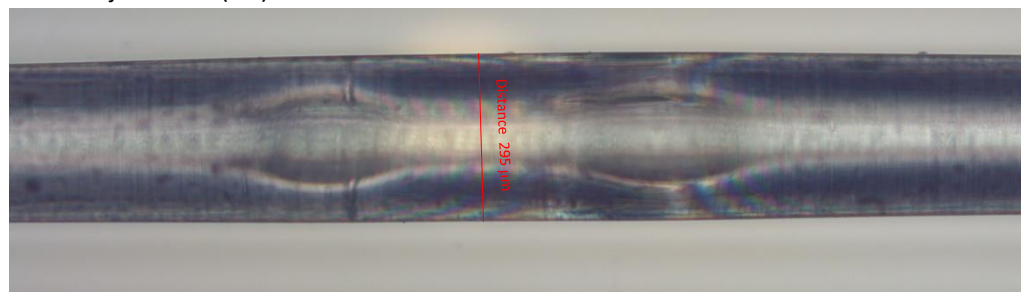

Projection 2 ($\sim y$)

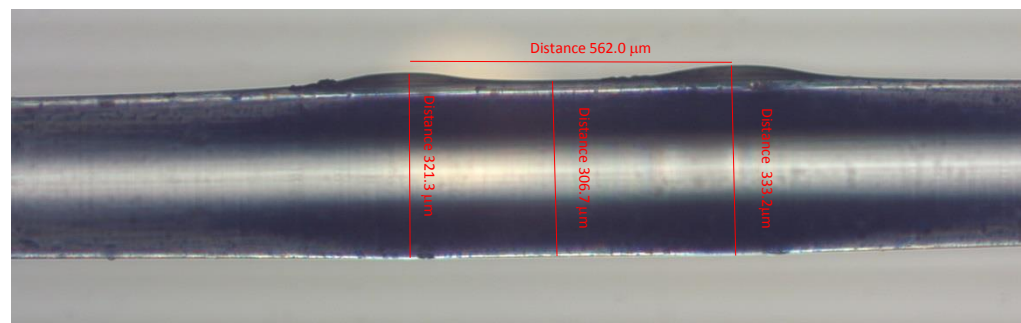

N.B. Correspondence between projections x,y and 1,2 is only approximate.

Set-up for measuring the light yield with ionising radiation (Sr-90 source)

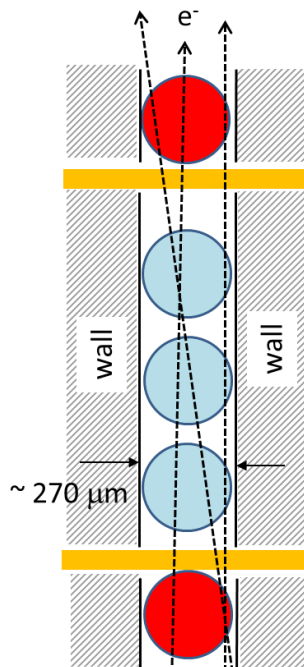
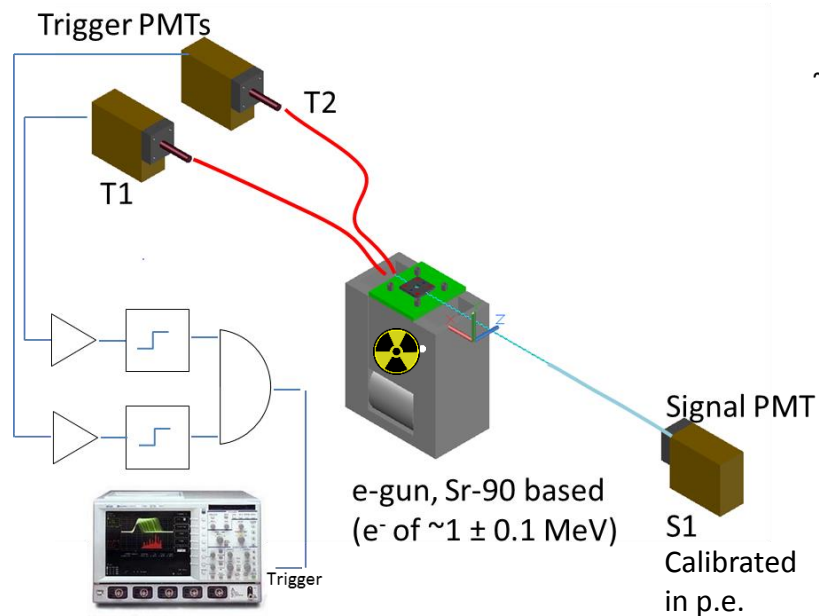

Manual set-up at CERN.

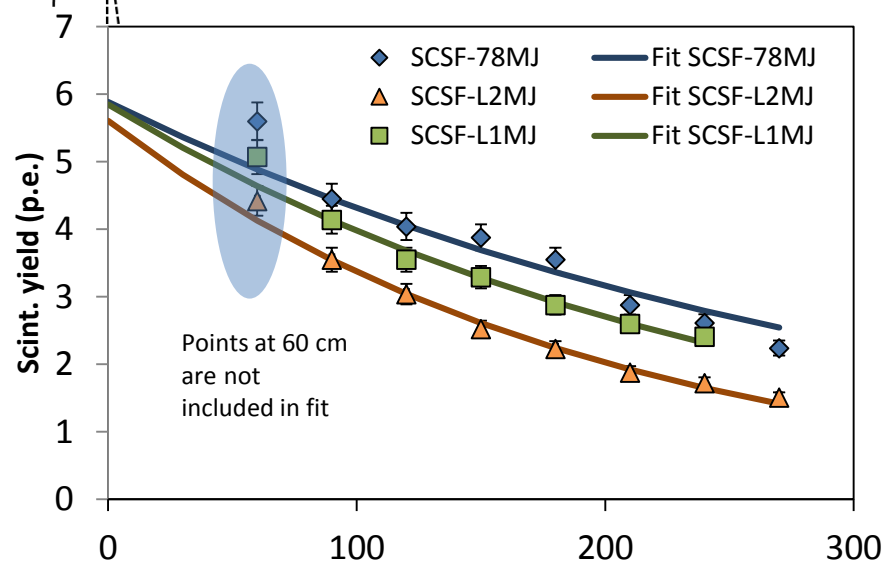
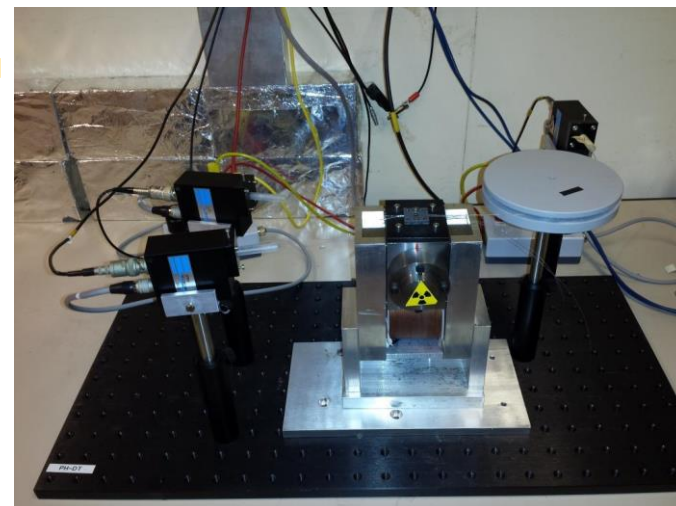

Complex irradiation of a 2.5 m long fibre module in the new PS IRRAD zone (Oct 2015)

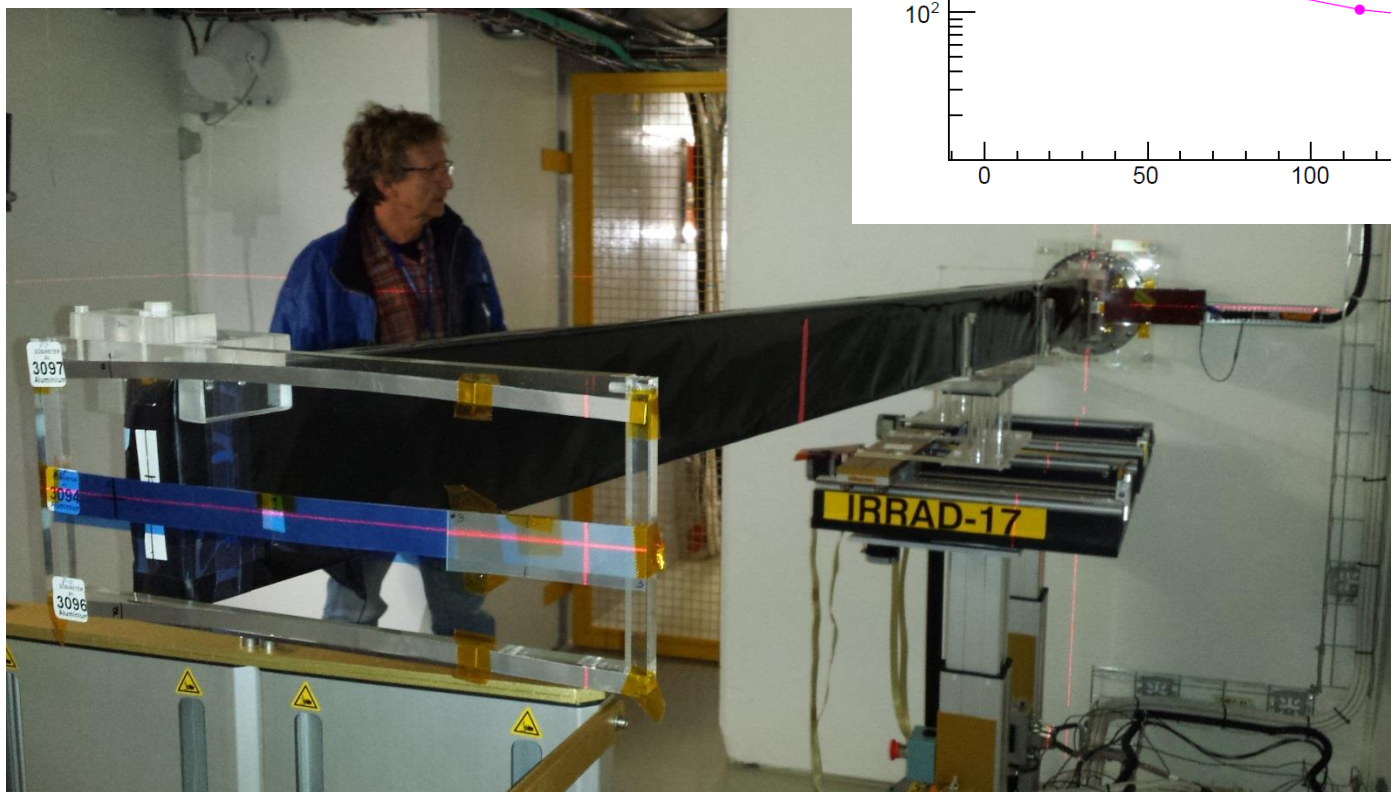
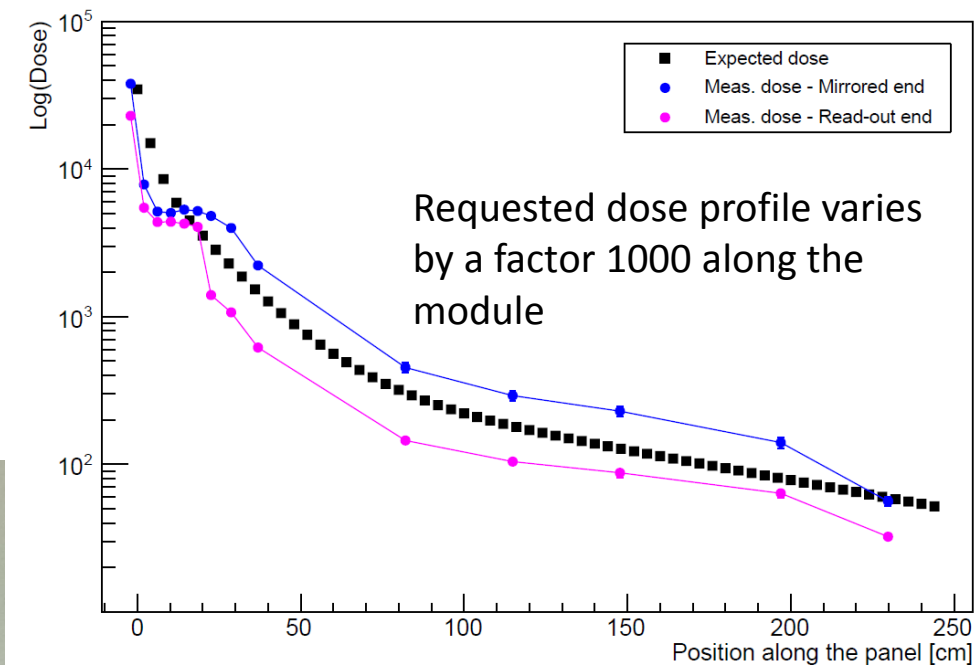

Find better fibres which give more light

LuminnoTech (Rus), Kuraray (JP) and CERN work on a new type of scintillating fibre.

Nanostructured Organo-silicon Luminophores (NOL)

On paper, it's a little revolution. In practice, the quality isn't good enough yet. Perhaps a solution for SciFi upgrade?

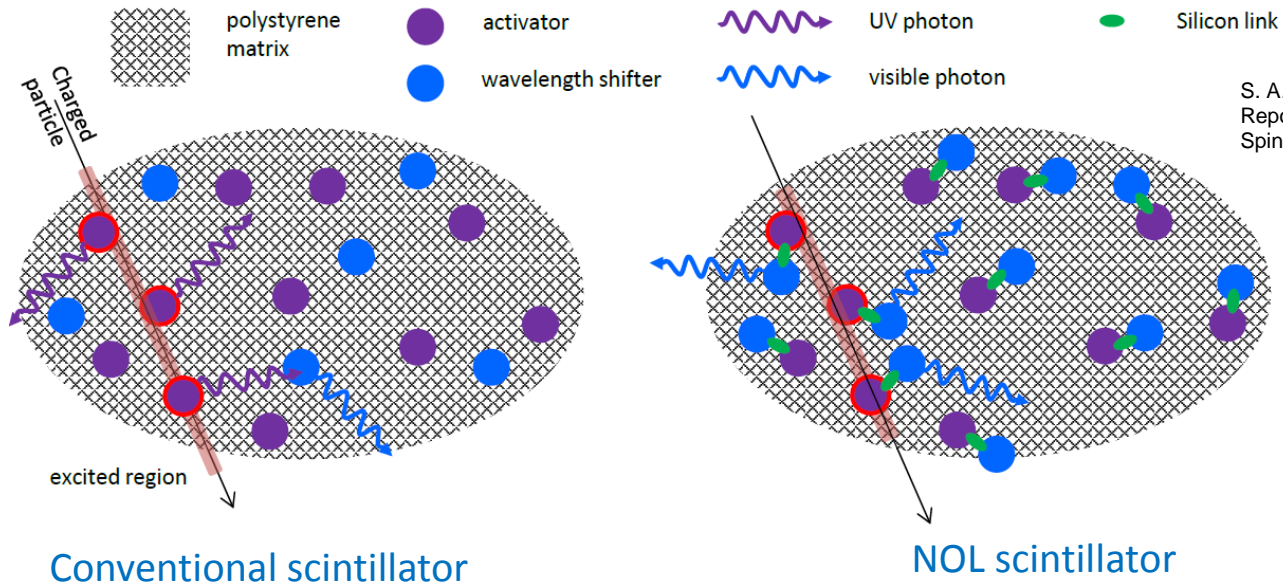

S. A. Ponomarenko et al., Nature Scientific Reports 4, Article number: 6549.
Spin-off company Luminnotech

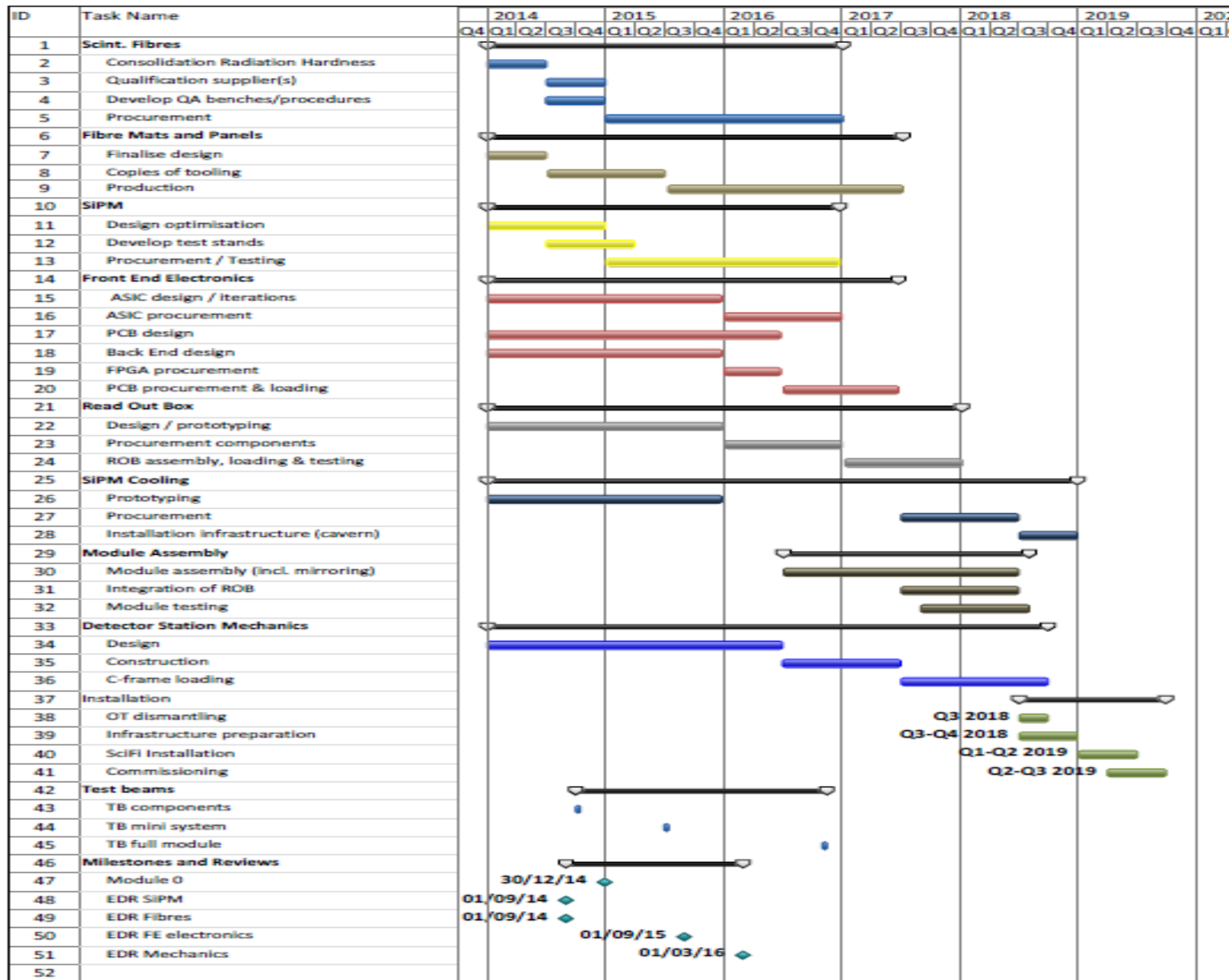

Geometrical precision

- Fibre mats are produced by winding fibres, layer by layer, on a fine-pitch threaded wheel

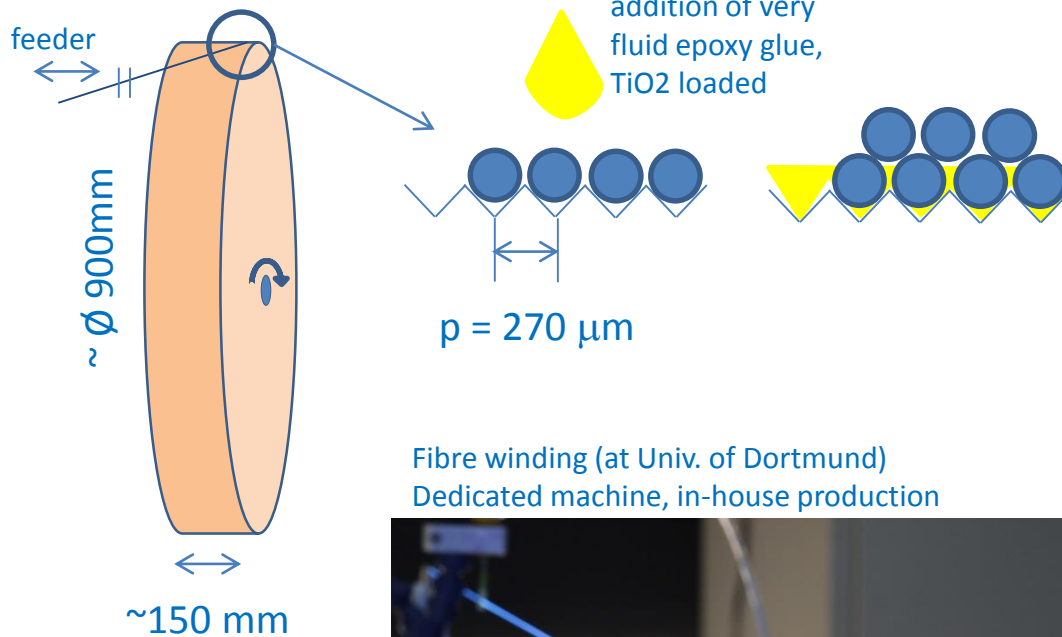

Fibre winding (at Univ. of Dortmund)
Dedicated machine, in-house production

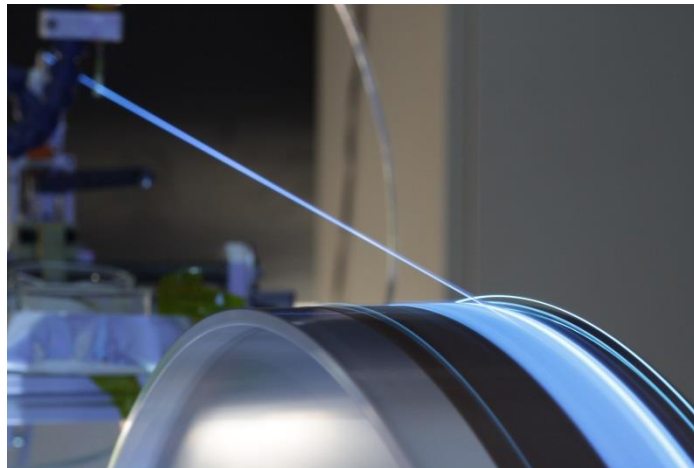

Test winding (at Univ. of Aachen)
Use of a large CNC lathe.



Geometrical precision

- Alternative technique: replace thread by a kapton film, structured with coverlay (© Dupont). PCB technique, R. de Oliveira.

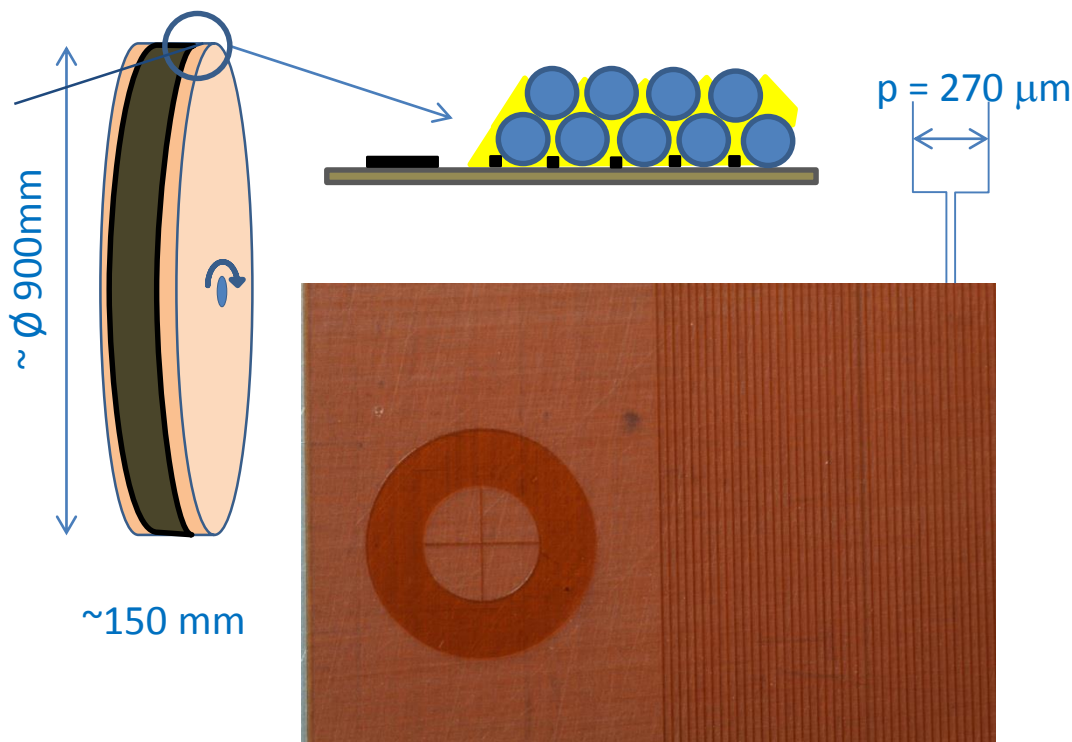

Kapton film becomes part of fibre mat.
Allows use of precise alignment marks.

3 m long and 16 cm wide Kapton film used for a full-size 6 layer mat (march 2014).



Inspection at CERN



After winding at Univ. Dortmund

Scan of fibre mat end faces (after cut with diamond tool)

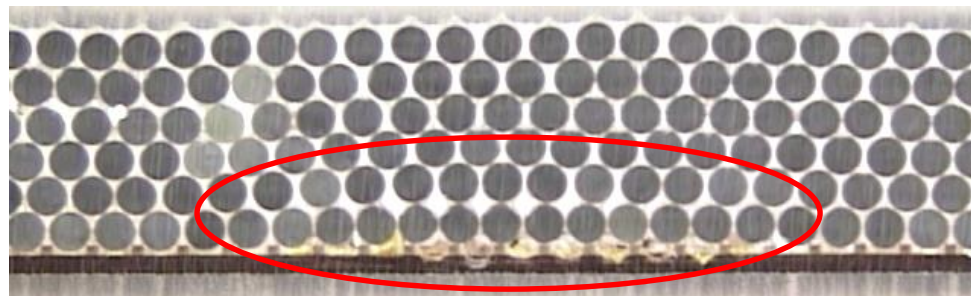
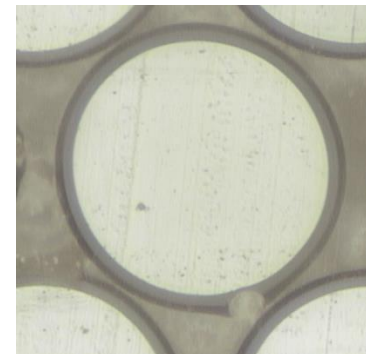

Optical 3D coordinate measurement machine (CMM) in PH/DT bond lab.

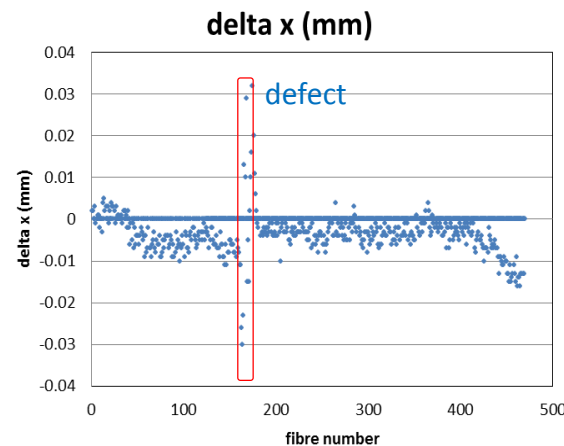
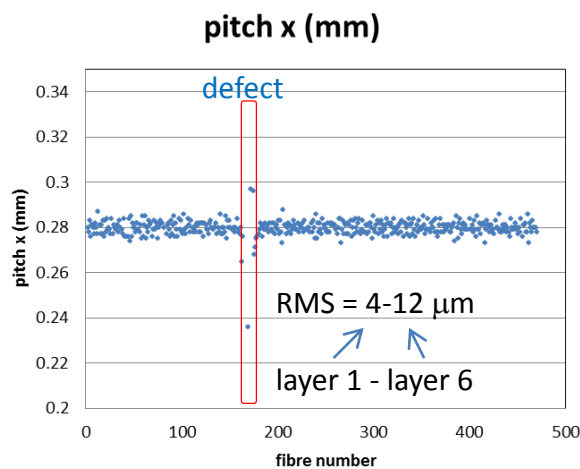
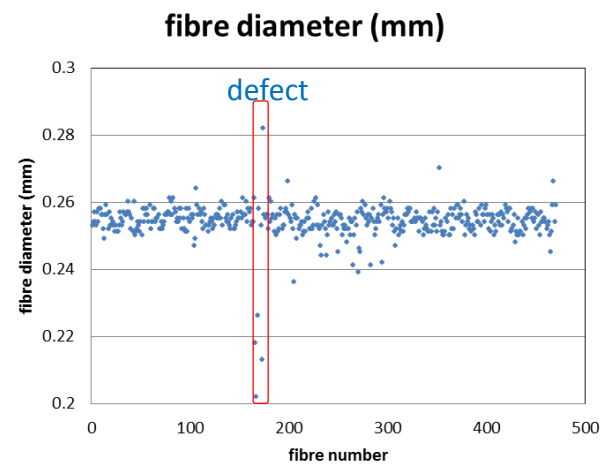

Get enough light → produce high quality mirror at non-read fibre end

50% of the scintillation light is emitted in the wrong hemisphere.

We studied three different mirror technologies

- Aluminised mylar foil
- 3M Extended Specular Reflectance (ESR) foil
- Aluminium thin film coating (TFC)

and measured the intensity gain (mirror/no mirror*)

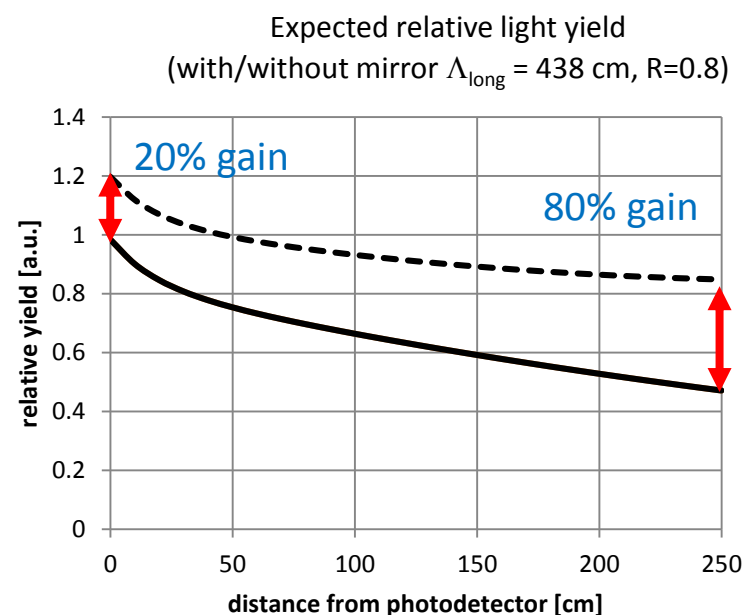
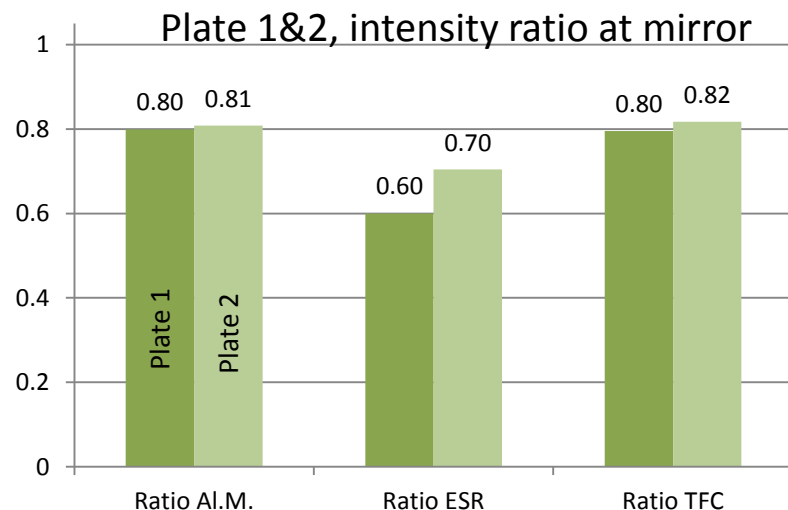

It remains unclear why ESR results are so low. Would have expected \geq Al. Mylar.

We checked for possible influence of angle of incidence as well as glue type. No change.

Get enough light → maximise fibre attenuation length

CERN set-up for measurement of attenuation length

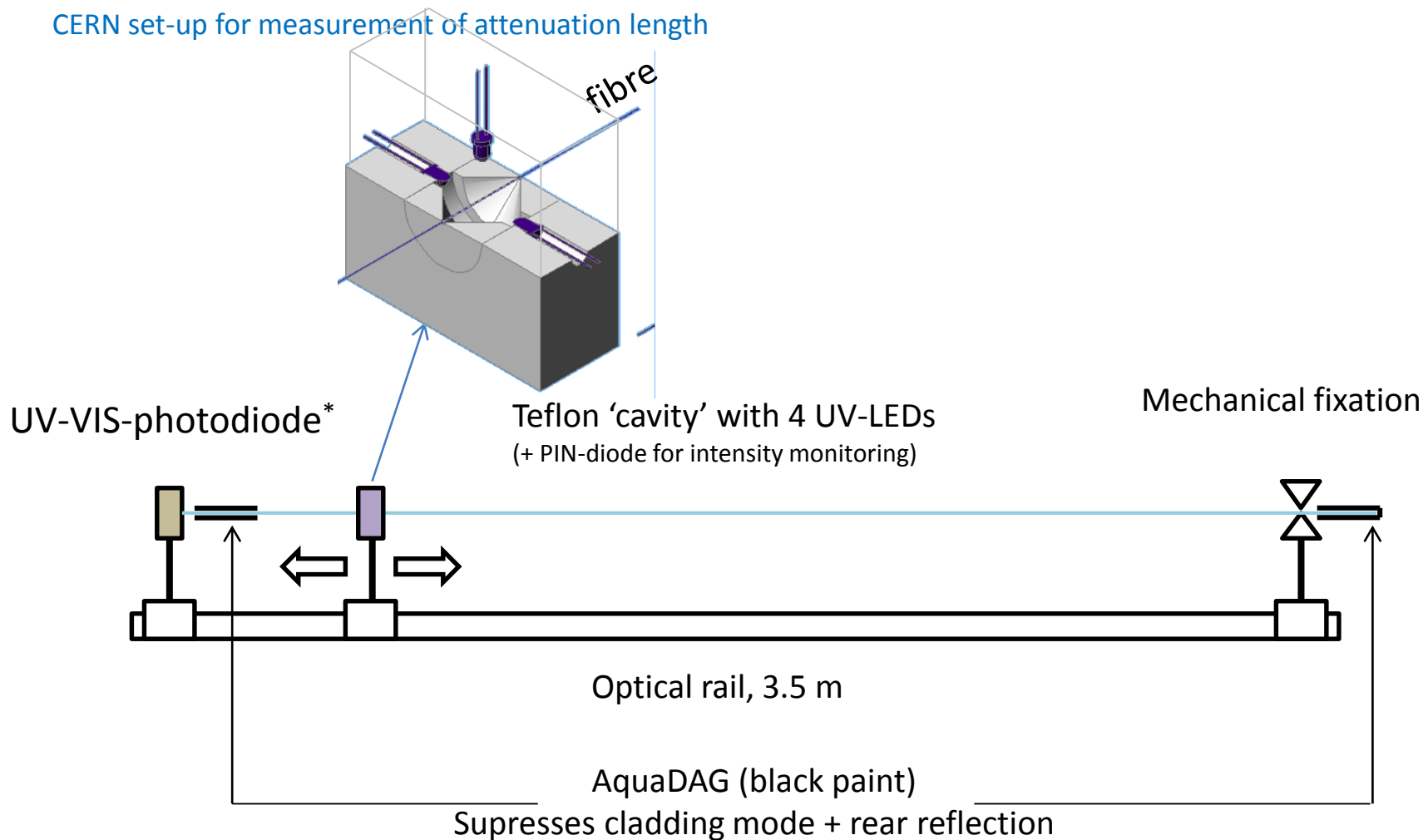

*May be replaced by a SiPM, to have correct sensitivity characteristics.

Measurements of 8 spools + older Dortmund sample (unknown Lot no.)

KURARAY SCSF-78, 250 μm , double cladde(d)

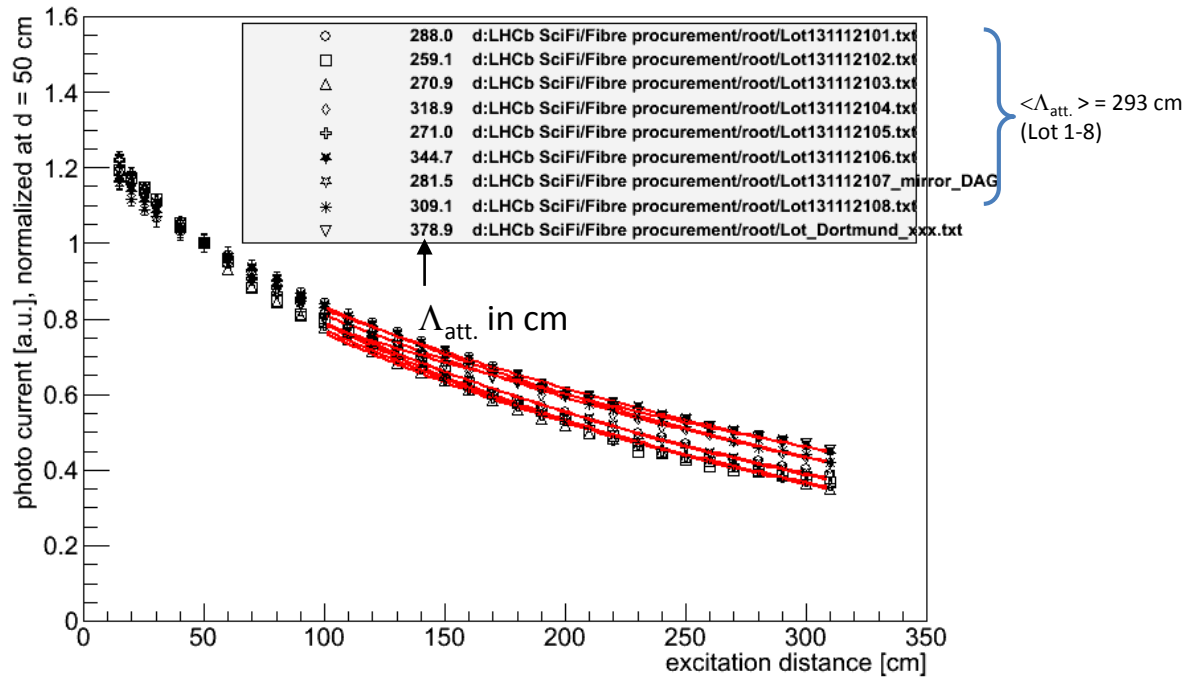

We are currently investigating with Kuraray whether lower or higher concentrations of dopants have a sizable impact on Λ or whether we have to live with $\Lambda \sim 3-4$ m.

Side remark: We are also maintaining / building up relations to 2 other potential fibre producers: Saint-Gobain (Bicron), ELJEN Technologies (new in the SciFi market).

Scintillation in organic materials

- The organic scintillation mechanism is based on the pi-electrons (molecular orbitals) of the benzene ring (C_6H_6).

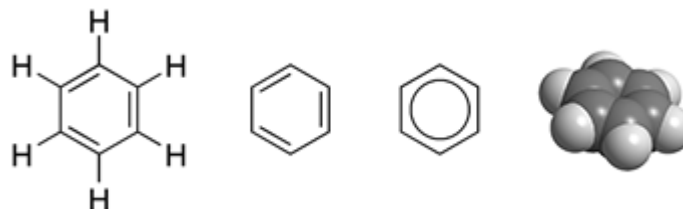

Molecular states (pi orbitals)

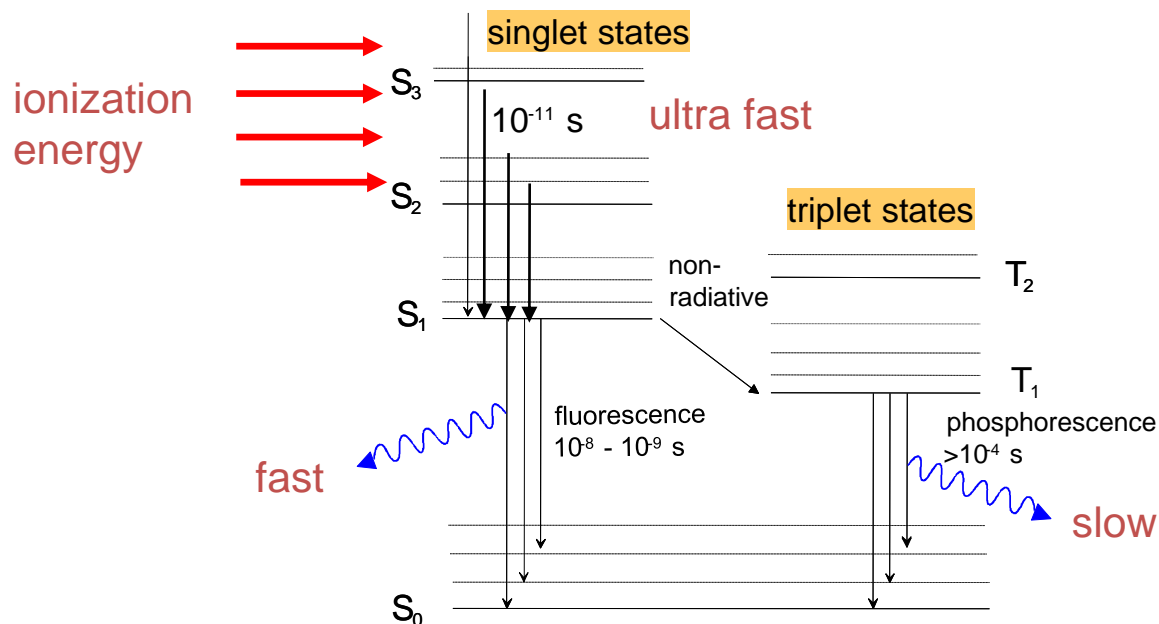

Organic scintillators exist as

- Crystals (anthracene)
- Liquids (solutions)
- Plastics (polymerized solutions)

Organic scintillators are fast. Scintillation light decay time \sim few ns.

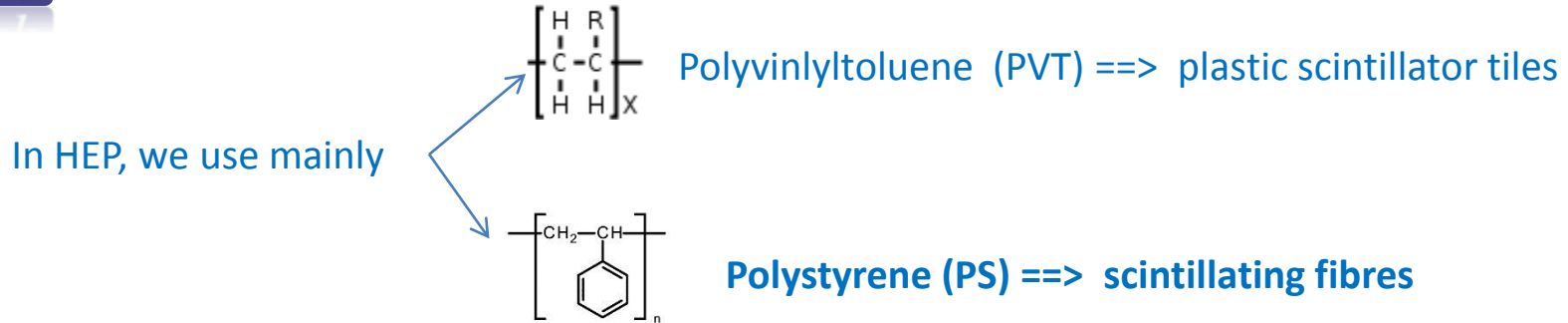

In pure form, both PVT and PS, have a very low scintillation yield.
 One adds therefore dopants in ‰ - ‰ concentrations.

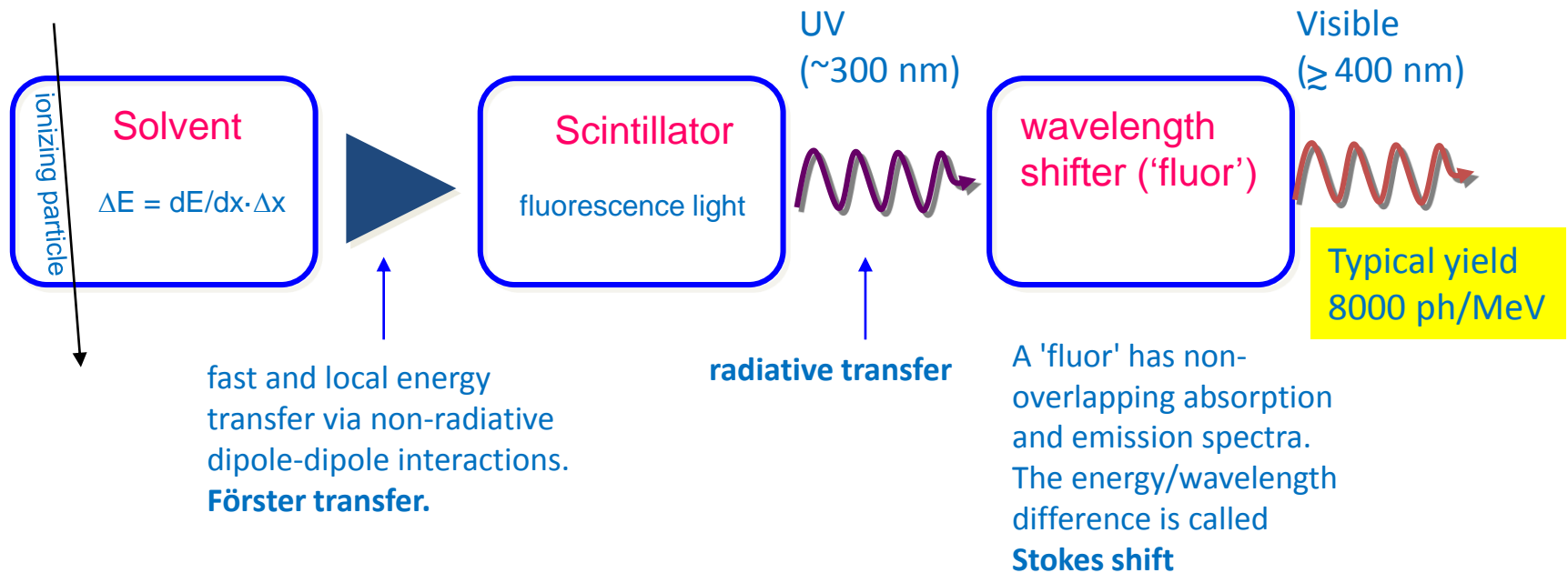

(Producers normally don't disclose the details about the additives and their concentrations.)