

First full calibration and reconstruction of a HEP detector in real time



Barbara Storaci

on behalf of the LHCb Collaboration



Detector Seminar, October 9th 2015

Layout

- The LHCb experiment
- The challenge: doing a full calibration and reconstruction in real-time
 - New resources
 - Improved reconstruction chain
 - Calibration and alignment on the online farms
- How it converts into physics:
 - The Turbo stream and the early measurements
(see also the [talk](#) of Patrick Spradlin, Wednesday 7th October)

The LHCb experiment

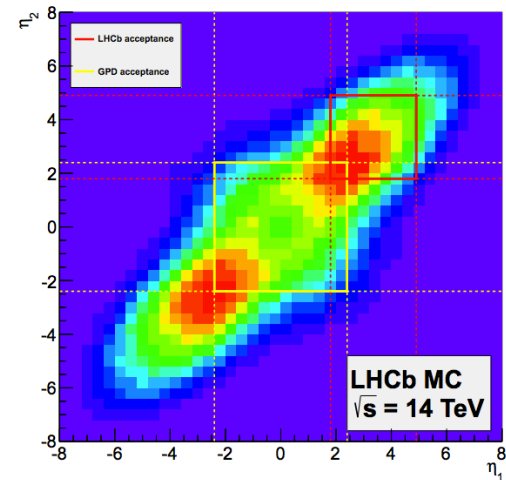
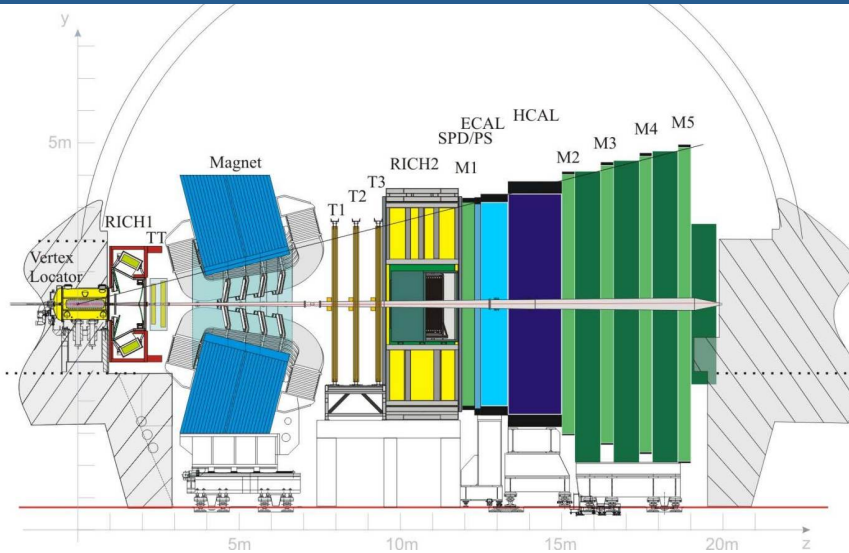

- LHCb is the dedicated heavy flavor physics experiment at LHC
- Single arm forward spectrometer, covering a pseudorapidity range unique among the LHC detectors
- Its primary goal is to look for indirect evidence of new physics in CP-violation and rare decays of beauty and charms hadrons
- This requires:
 1. Excellent tracking (momentum, impact parameters and primary vertex resolution)
 2. Excellent decay time resolution
 3. Excellent particle identification

The tracking systems

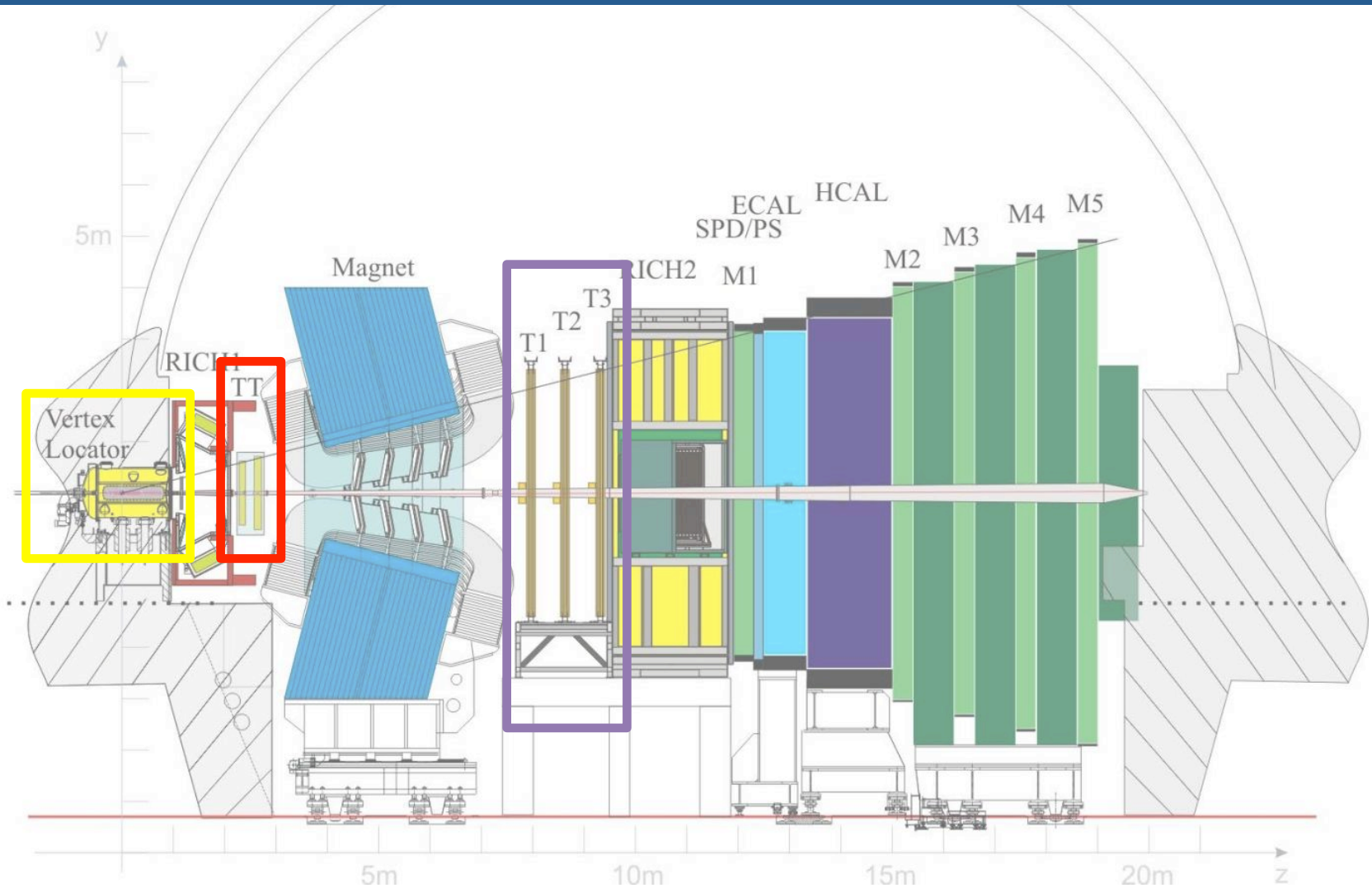

Vertex Locator (VELO)

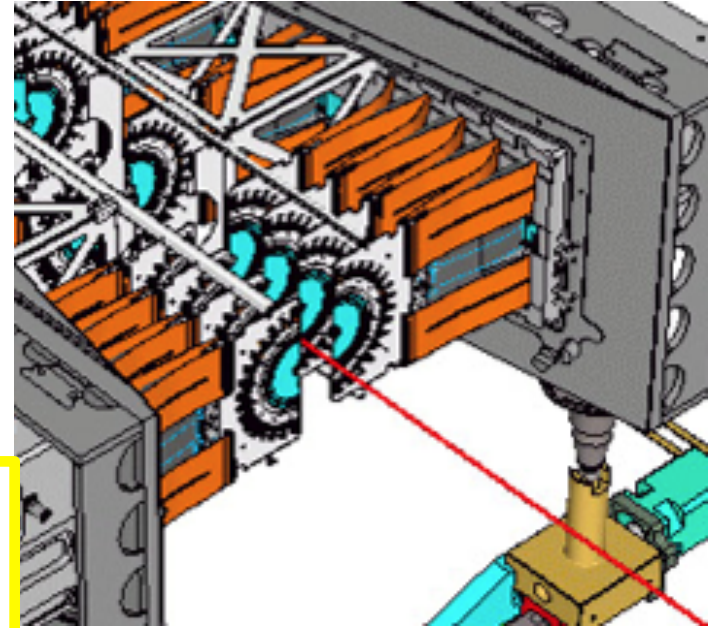

Vertex Locator (VELO):

- 42 silicon micro-strip stations with r-Phi sensors
- Surrounding interaction point
- Two retractable halves, 8 mm from beam when closed
 - **Closed for each fill**
- **Possibility to inject gas (like He, Ne, Ar) for special data taking**

Vertex Locator (VELO)

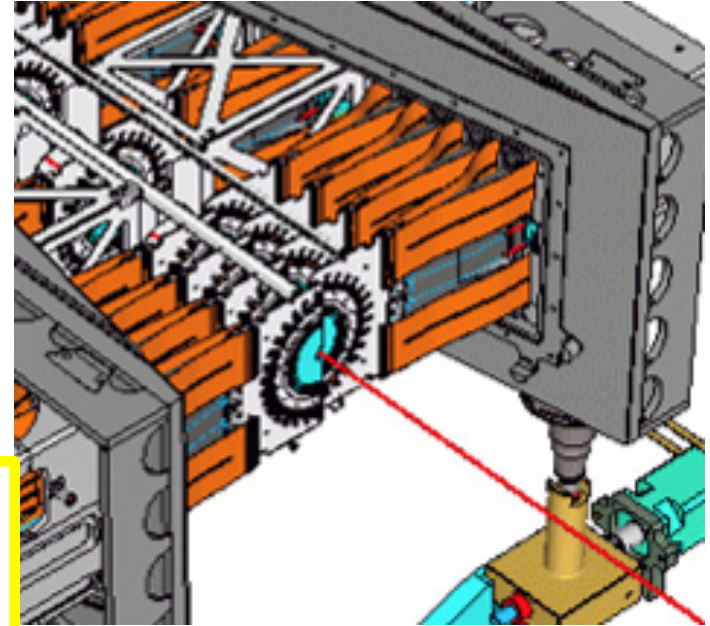

Vertex Locator (VELO):

- 42 silicon micro-strip stations with r-Phi sensors
- Surrounding interaction point
- Two retractable halves, 8 mm from beam when closed
 - **Closed for each fill**
- **Possibility to inject gas (like He, Ne, Ar) for special data taking**

Performance of the LHCb Vertex Locator
[JINST 9 \(2014\) 09007](#)

LHCb Detector Performance
[Int.J.Mod.Phys. A30 \(2015\) 1530022](#)

VELO performance in Run I

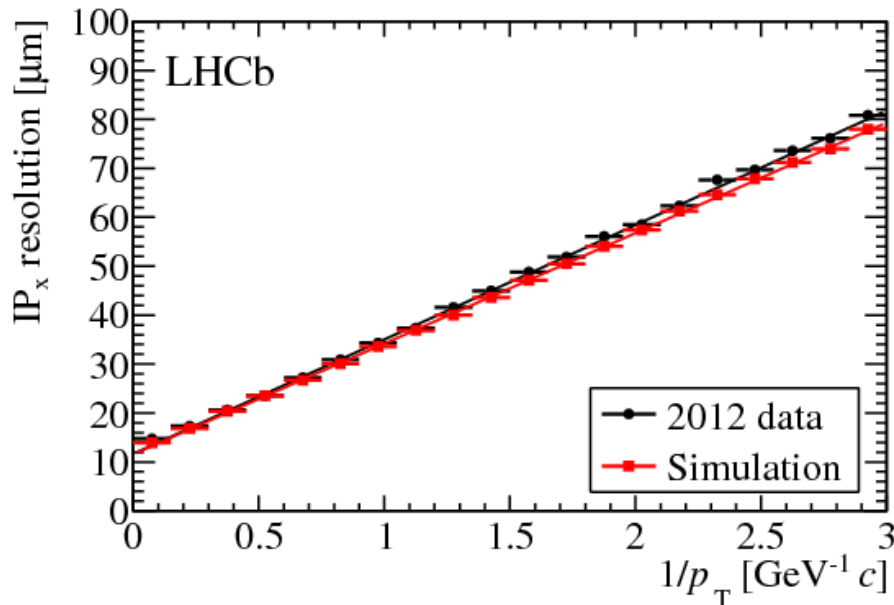

PV resolution of $\sim 12\mu\text{m}$ in x/y
 $\sim 71\mu\text{m}$ in z

Decay time resolution of 45 fs for a 4-tracks vertex

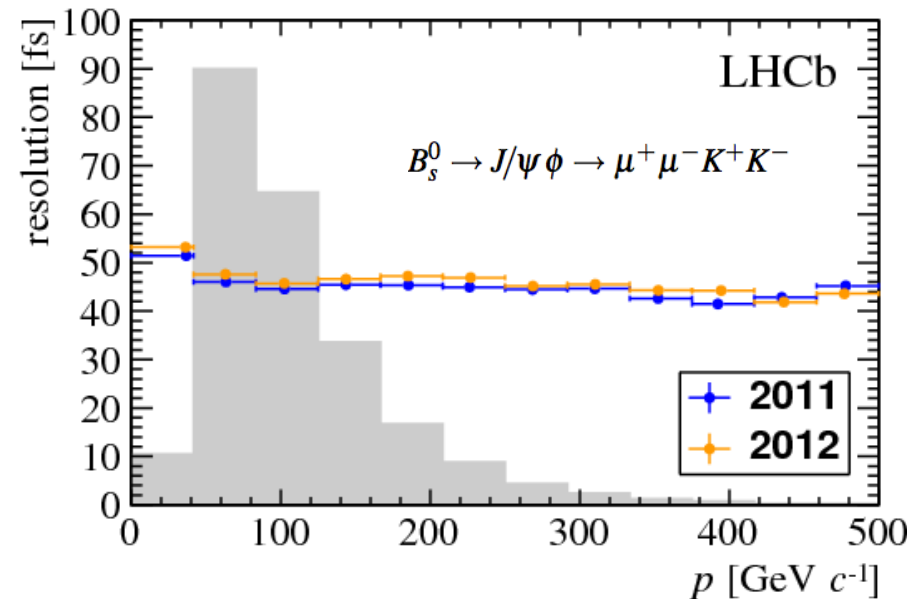

[JINST 9 \(2014\) 09007](#)

[Int.J.Mod.Phys. A30 \(2015\) 1530022](#)

Tracker Turicensis (TT)

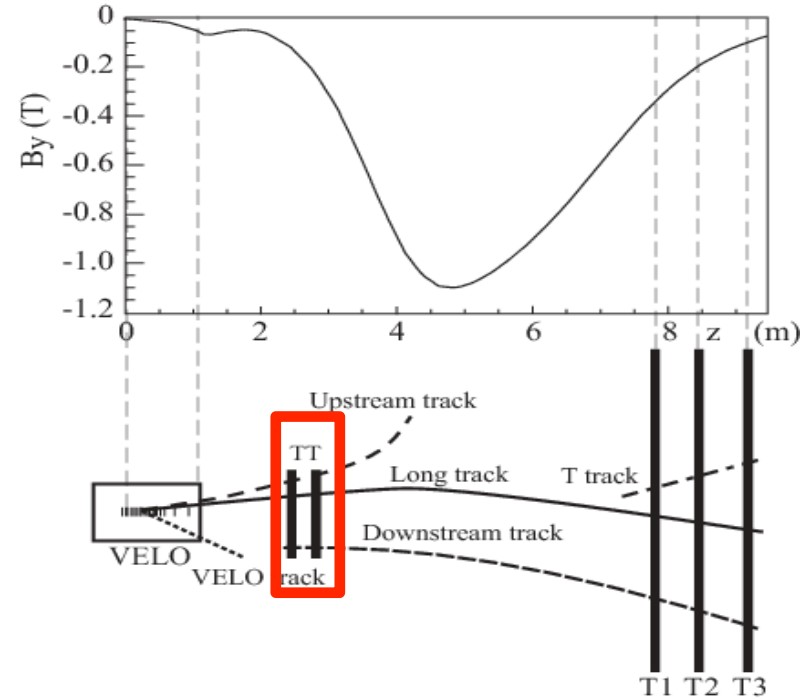
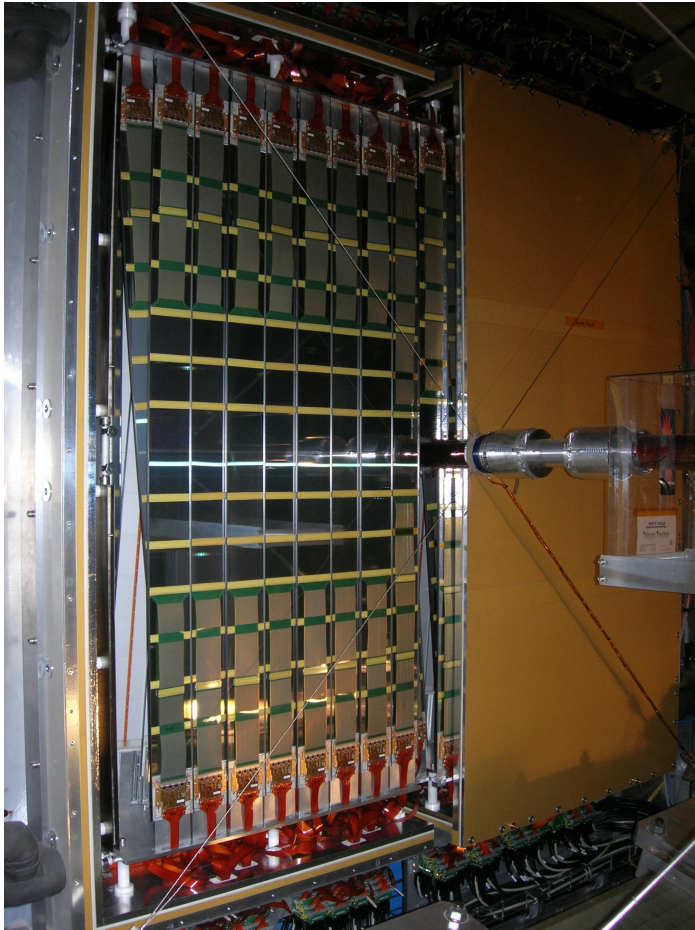

LHCb Detector
Performance

[Int.J.Mod.Phys. A30 \(2015\)
1530022](#)

Tracker Turicensis (TT):

- Four planes ($0^\circ, +5^\circ, -5^\circ, 0^\circ$) of silicon microstrip sensor
- Total silicon area of 8m^2
- The detector operate at 0°C .
- Upstream of the magnet
- **Already sensitive to the magnetic field**

Inner and Outer Trackers (IT and OT)

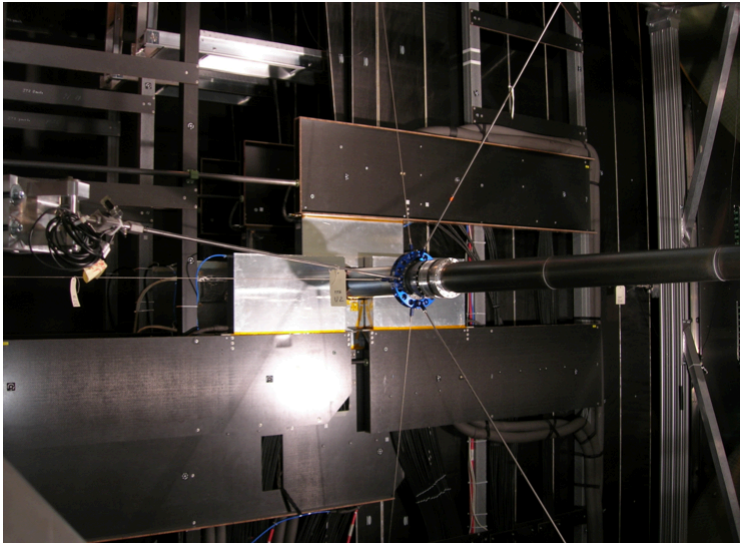

Inner Tracker (IT):

- Downstream of the magnet
- Three stations each with four planes of silicon micro-strip sensors around the beam pipe
- Total silicon area of 4.2m²
- The detector operate at 0°C.

Outer trackers (OT)

- Downstream of the magnet
- Three stations each with four planes of straw tubes
- Gas Mixture Ar/CO₂/O₂ (70/28.5/1.5)

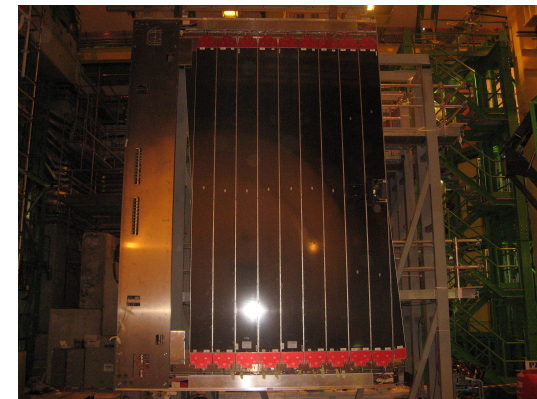
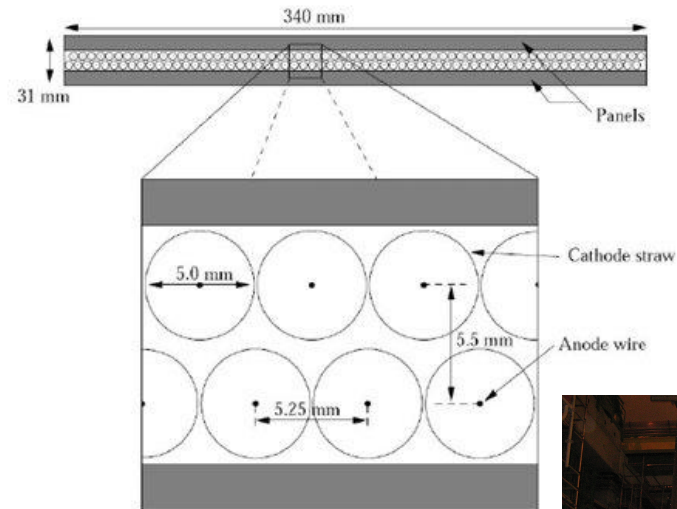

Performance of the LHCb Outer Tracker

[JINST 9 \(2014\) P01002](#)

LHCb Detector Performance

[Int.J.Mod.Phys. A30 \(2015\) 1530022](#)

Tracking performance

- Stable tracking efficiency in Run1
- Above 96% in all the momentum range for track traversing the full detector

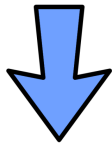

Resonance	Mass resolution (MeV/c^2)
J/ψ	14.3 ± 0.1
$\psi(2S)$	16.5 ± 0.4
$\Upsilon(1S)$	42.8 ± 0.1
$\Upsilon(2S)$	44.8 ± 0.1
$\Upsilon(3S)$	48.8 ± 0.2
Z^0	1727 ± 64

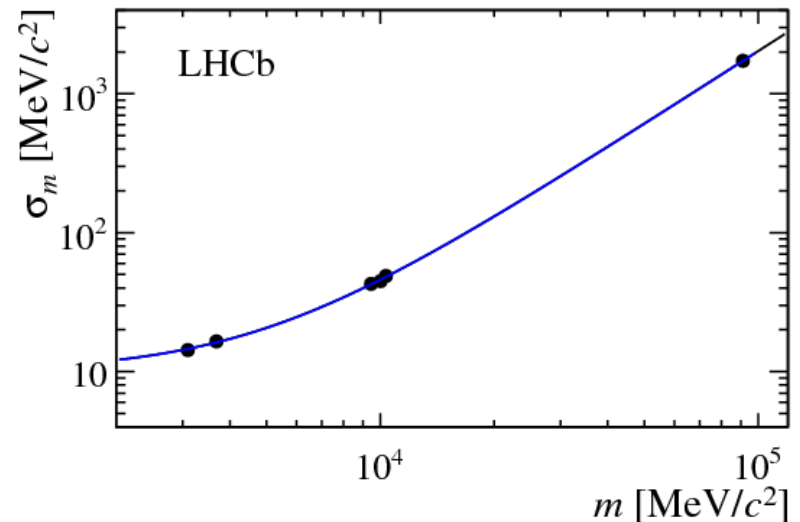
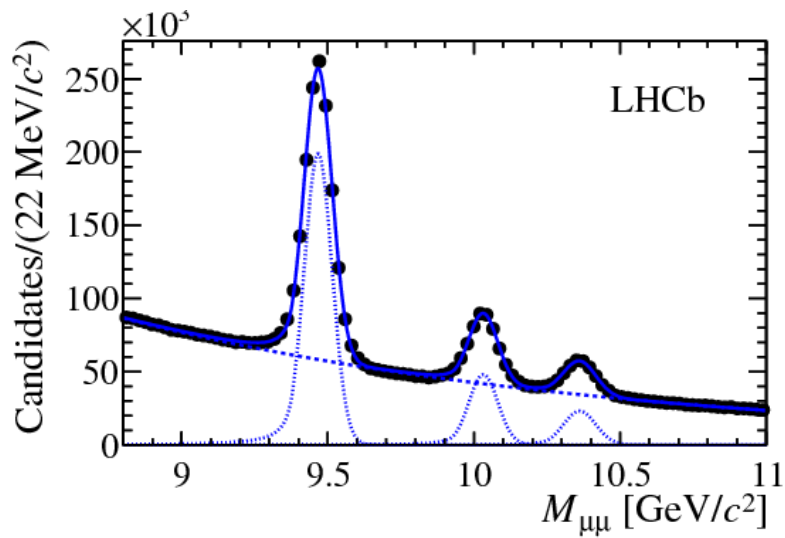
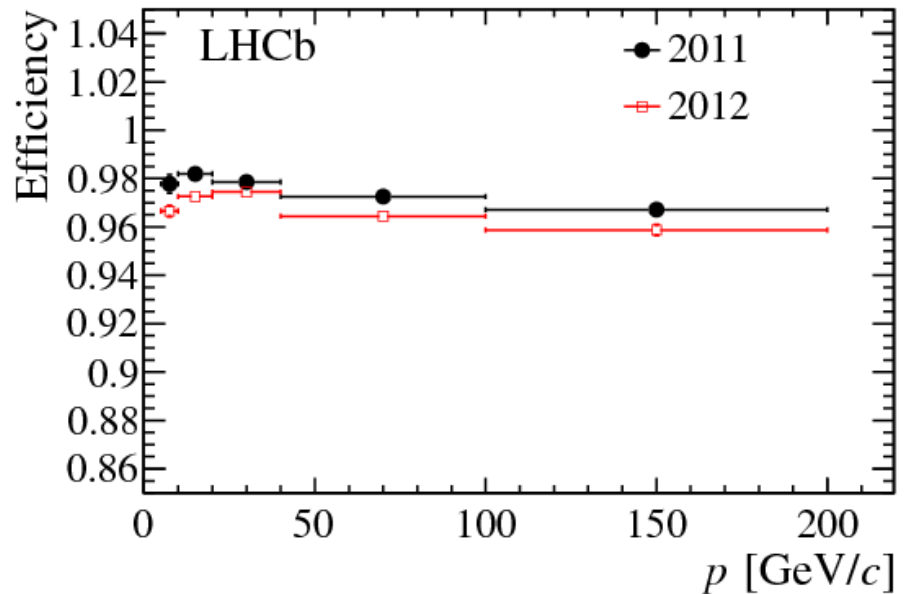

The PID systems

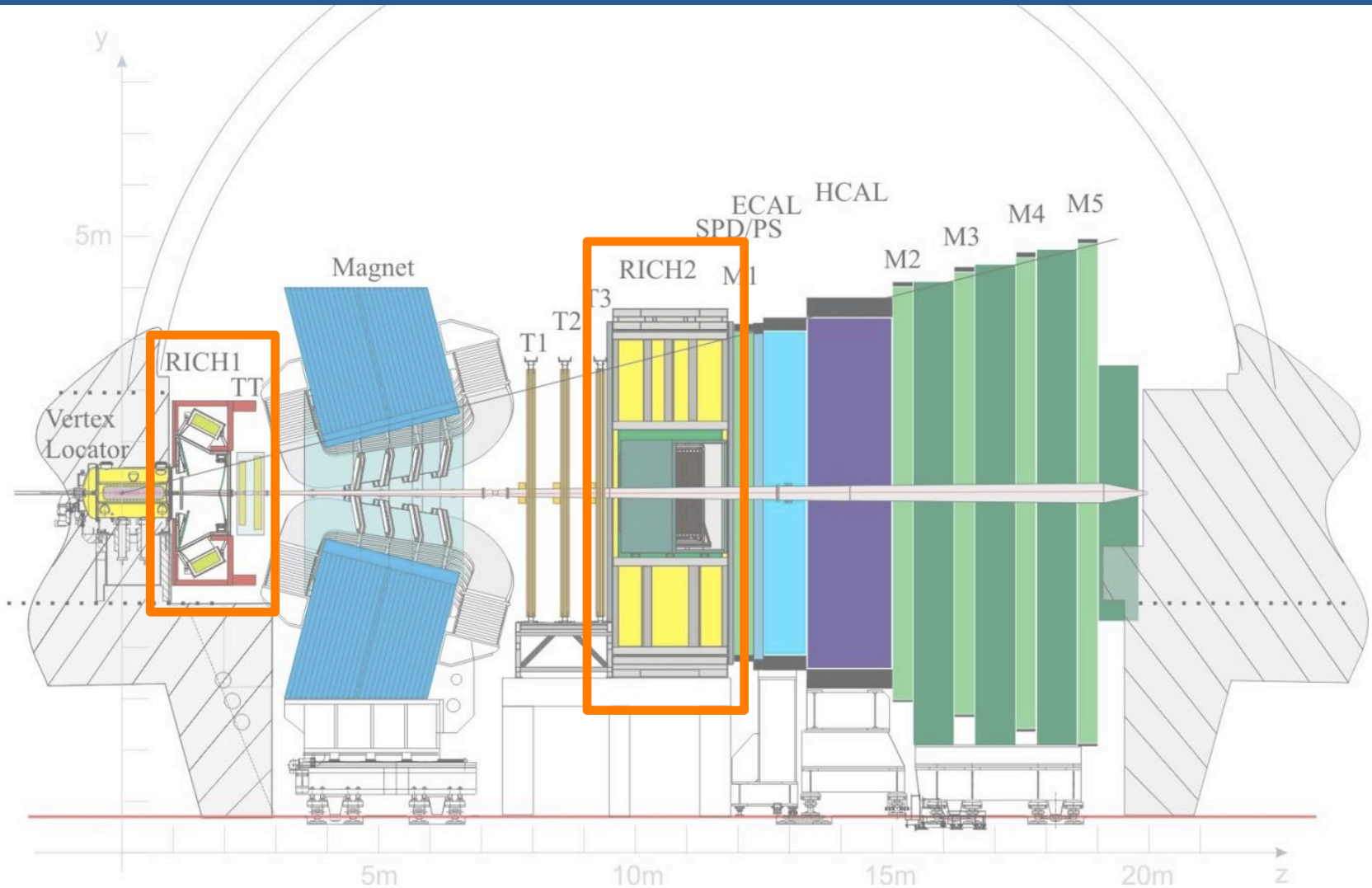

The PID systems

RICH1

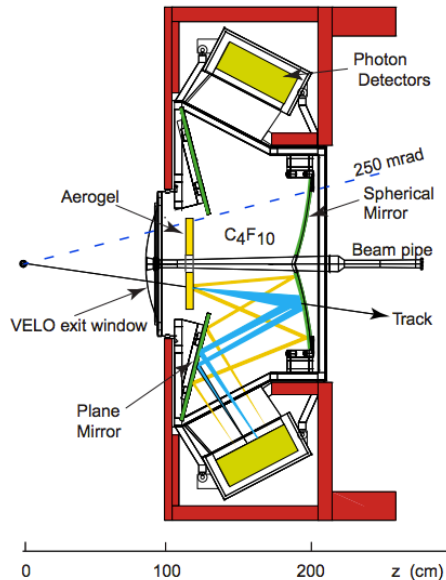

RICH2 spherical mirrors

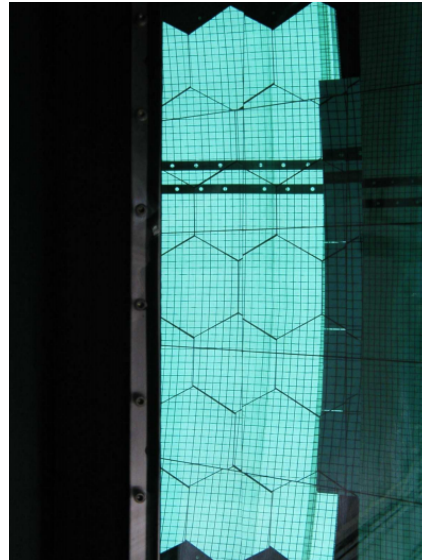

Hybrid Photon Detectors

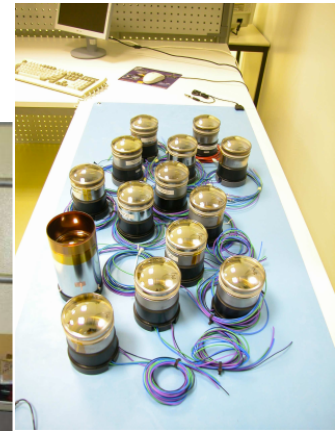
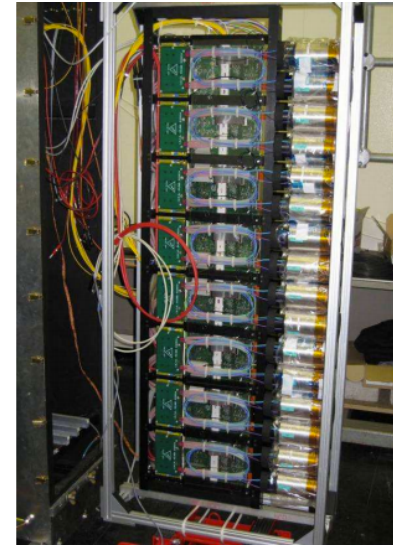

Ring Imaging Cherenkov detectors (RICH1 and RICH2)

- RICH1:
 - Upstream of the magnet
 - C_4F_{10} radiator
 - $2 < p < 40$ GeV/c
 - 25-300 mrad
- RICH2:
 - Downstream of the magnet
 - CF_{10} radiator
 - $15 < p < 100$ GeV/c
 - 15-120 mrad

Performance of the LHCb RICH detector
[Eur.Phys.J. C73 \(2013\) 2431](#)

LHCb Detector Performance
[Int.J.Mod.Phys. A30 \(2015\) 1530022](#)

The trigger and PID systems

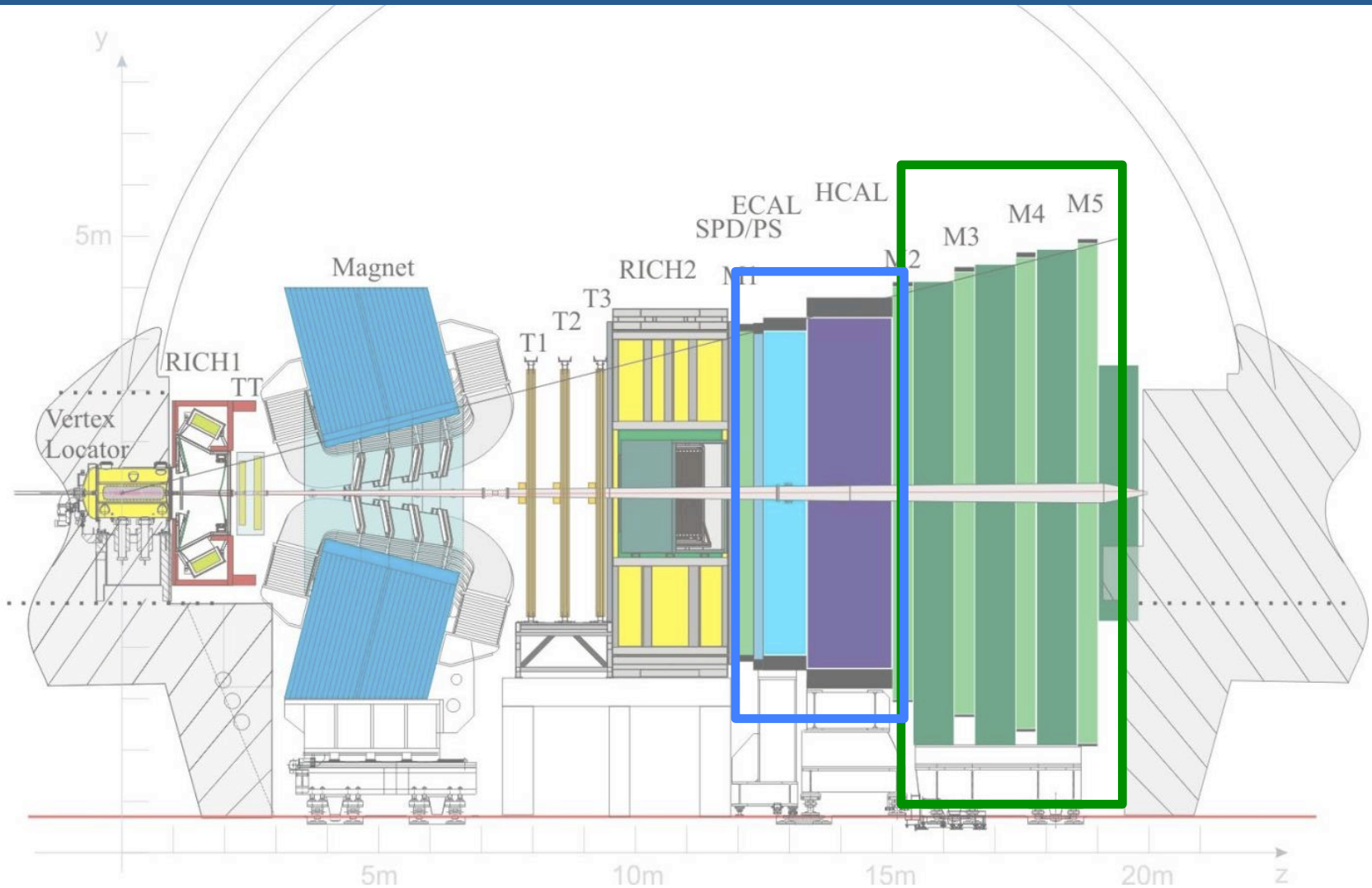

The trigger and PID systems

Electromagnetic and hadronic calorimeters (ECAL and HCAL)

- Scintillator planes + absorber material planes
- Provide the Level 0 signature for events with hadrons above a certain E_T
- Offline PID for photons, electrons and hadrons

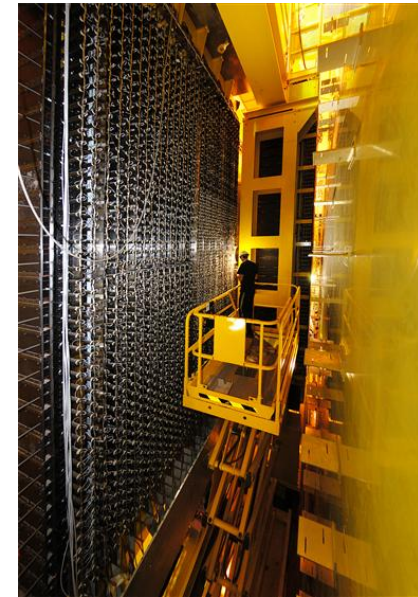

ECAL

Muon multi-wire proportional chambers

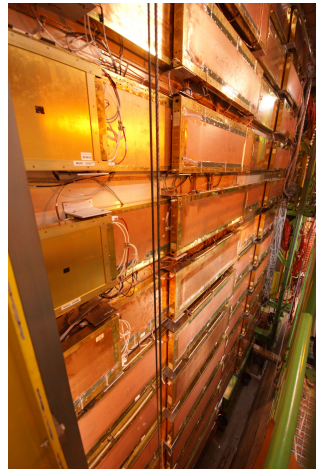

Muon system

- 5 stations, each equipped with 276 multi-wire proportional chambers
 - Inner part of the first station equipped with 12 GEM detectors
- Level 0 trigger selection of tracks with high p_T
- Offline PID of muons

The PID performances

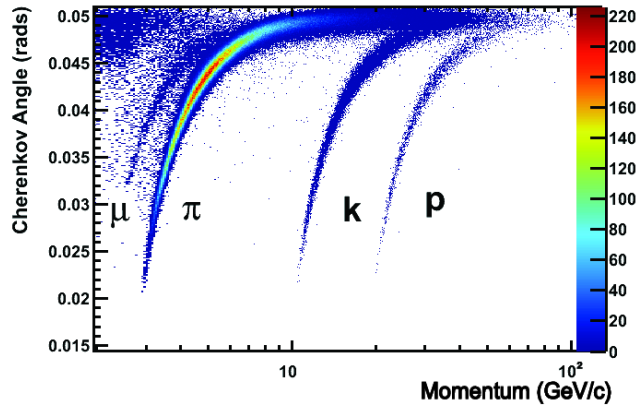

Kaon identification efficiency $\sim 95\%$
with a pion **mis-identification** fraction
of **$\sim 10\%$** over the full 2-100 GeV/c
momentum range (tight selection)

Capability to distinguish particles
(especially π -K) in the
momentum range 2-100 GeV/c)

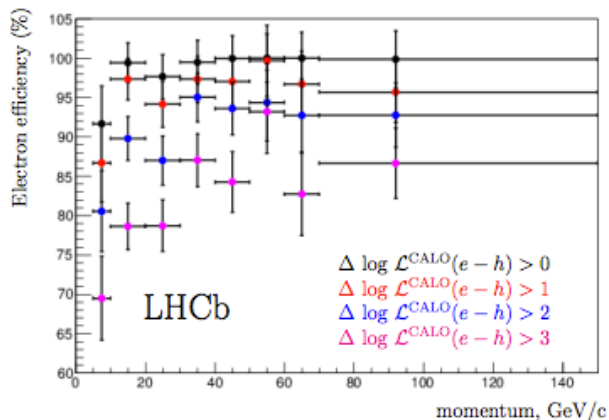
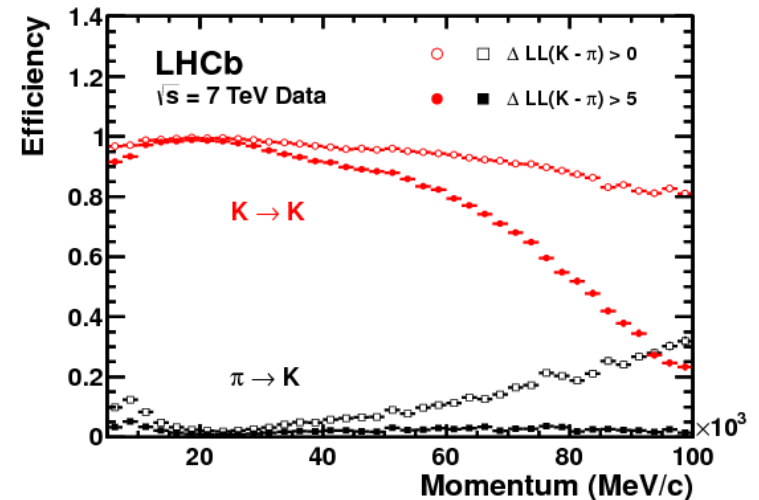

Electron identification efficiency $> 91\%$
with a hadron mis-identification fraction
of **few % $p > 10$ GeV/c** (intermediate
selection)

Trigger in Run1

- Level 0: **1MHz rate**
 - Implemented in hardware
 - High p_T and E_T signature in muon and calorimeter systems
- Higher Level Trigger (HLT): **5kHz rate**
 - Flexible software triggers with two stages (HLT1 and HLT2)
 - Track reconstruction and PV finding performed
 - Simplified reconstruction w.r.t. offline
 - Preliminary alignment and calibration
 - RICH PID info marginally used (not fully calibrated system)
- Processing of the data at the end of the year with the latest constants
- Only 20% deferred to disk

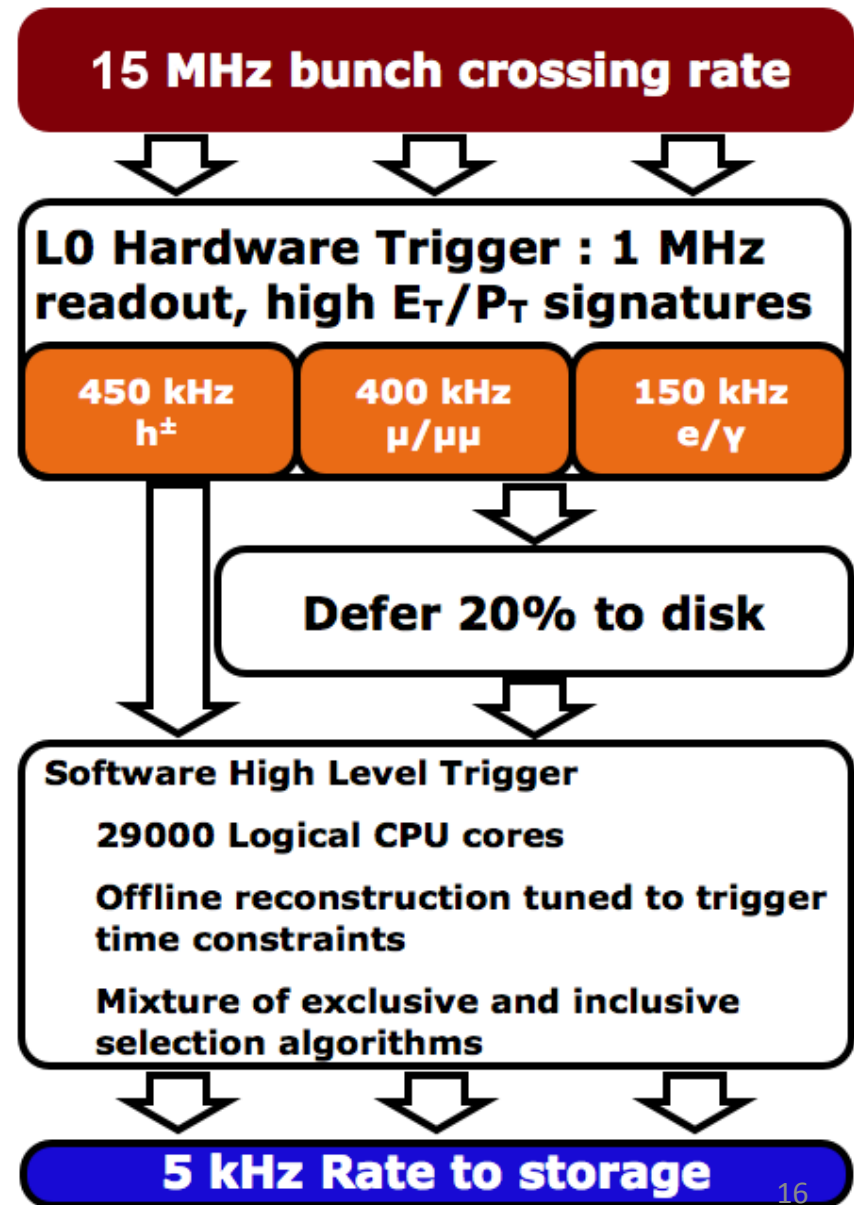

Idea

Novel concept in HEP:
Being able to do physics directly on the HLT output

Advantages:

- No need of offline data processing (data available ~ immediately after HLT2 has processed them)
- Raw event size can be much smaller → possibility to reduce the pre-scaling of high branching ratio channels (like for charm physics)

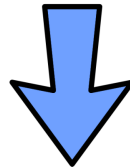

Do much more physics with the given resources!

Trigger in RunII

- Events from lower trigger levels can **be buffered on disk while performing real-time alignment and calibration**
- Last trigger level uses the **same reconstruction as offline**
- **Same alignment and calibration constants** used by the trigger and the offline reconstruction
- Some analysis performed directly on the trigger output

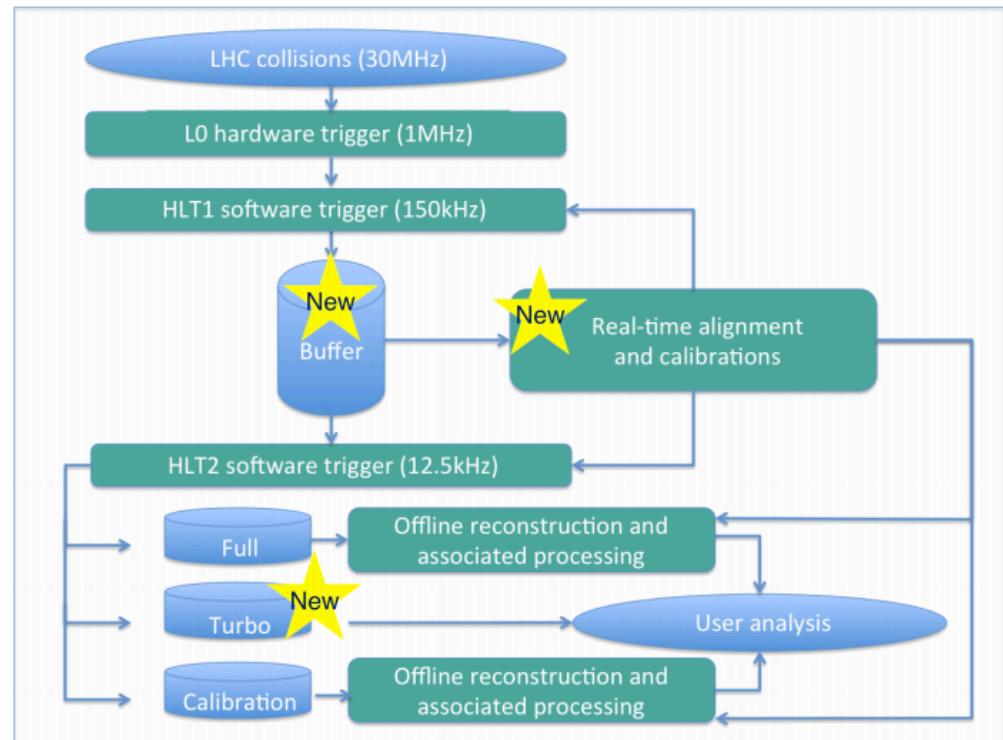

New resources

- HLT farm nearly doubled from Run I:
 - ~27k physical cores
 - Farm nodes added for RunII are about 2x more powerful than previous nodes
- Event can be buffered after HLT1: 5PB disk space

Still a difficult challenge:

- Managing to do the full reconstruction in few hundreds ms achieving offline performance (same or better than in RunI)
- Managing to do the full alignment and calibration of the detectors in real-time
- Being able to select efficiently many signals already at trigger level

Reconstruction chain optimization



Optimization of the reconstruction chain

- In order to maintain full reconstruction efficiency, while keeping within a strict timing budget many improvements were needed:
 1. Optimization of the code (e.g. vectorization)
 2. Changes to the reconstruction chain and optimization of the pattern algorithm

Optimization of the reconstruction chain

1. Optimization of the code (e.g. vectorization):

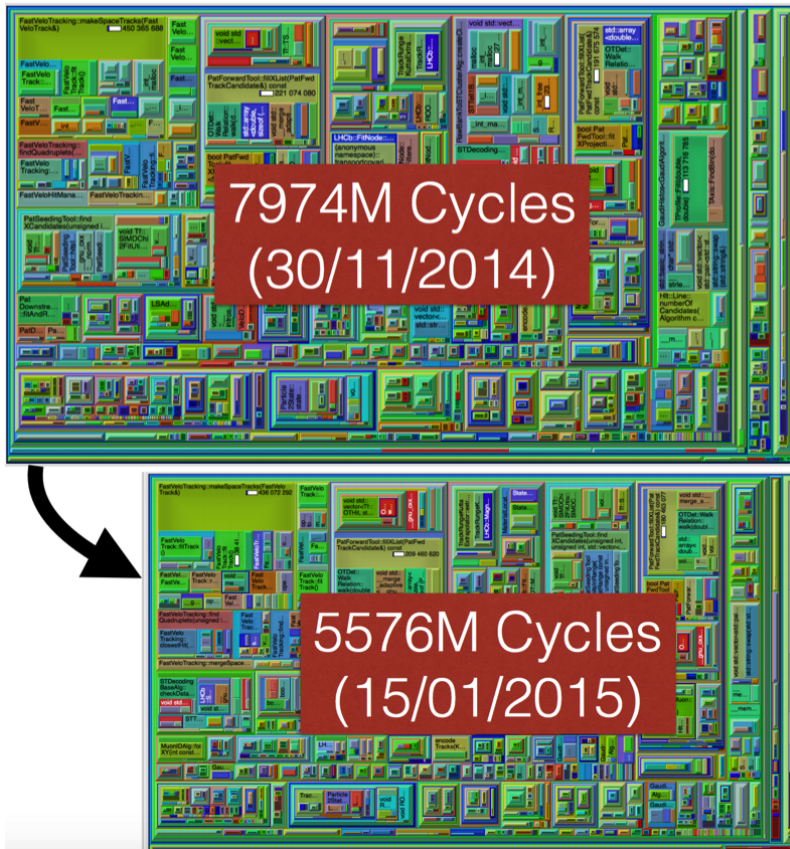

Examples

- Identified hot spots by profiling
 - **Vectorisation (track fit, magnetic field)**
- Caching (material description)
- Fast approximations
- Algorithms tuning and re-implementation

=> Possible to gain order of ~30% in several algorithms

Optimization of the reconstruction chain

2. Changes to the reconstruction chain and optimization of the pattern algorithm:

- Velo tracks can be extended to the TT detector

Advantages:

- The TT detector is already in the magnetic field: possible to estimate q/p (resolution $\sim 15\%$)
- Momentum estimate used to pre-select tracks at an early stage
- Charge estimate allows greatly reduced search windows downstream of the magnet

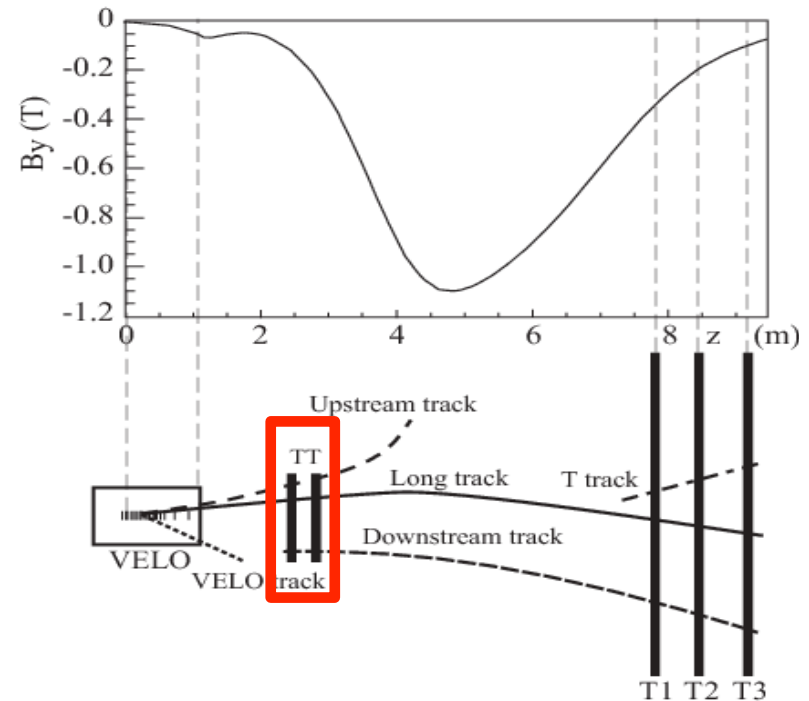

Optimization of the reconstruction chain

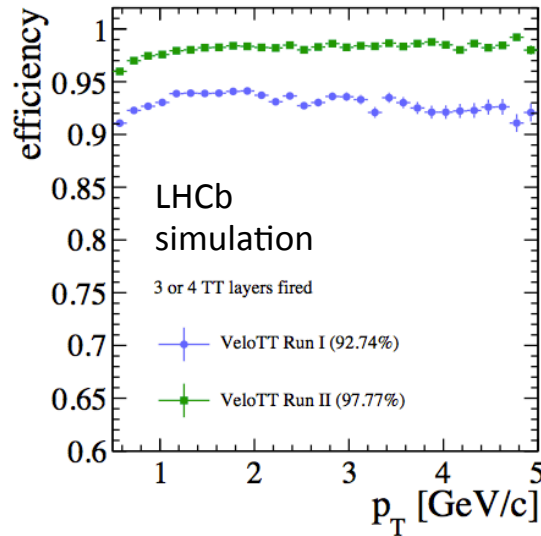
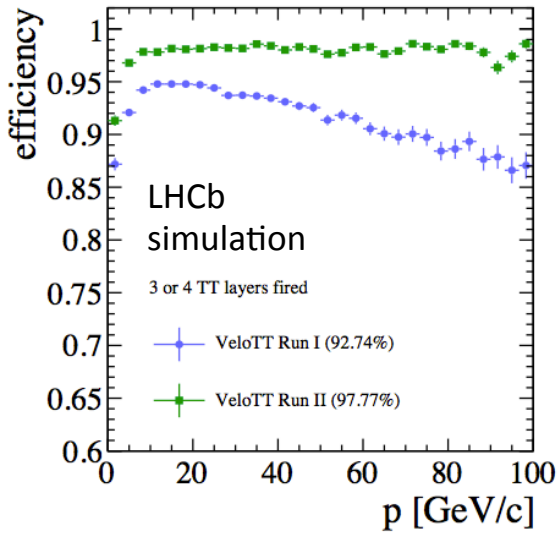

New reconstruction chain:

- **~3 times faster**
- Better or equivalent performance as in Run I
- Tracks with a $p_T > 500 \text{ MeV}$ already available at **HLT1** level (in Run I $p_T > 1.3 \text{ GeV}$) **without any IP requirements needed.**

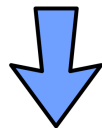

- **Gains >50% signal efficiency for charm physics**
- **Enable lifetime unbiased triggers for hadronic final states (world first!)**

VELO-TT performance:

- More than **97% efficient** for tracks with $p_T > 200 \text{ MeV}$ that have hits in at least three layers
- **~5% better performance** than previous code (never used since it was too slow)

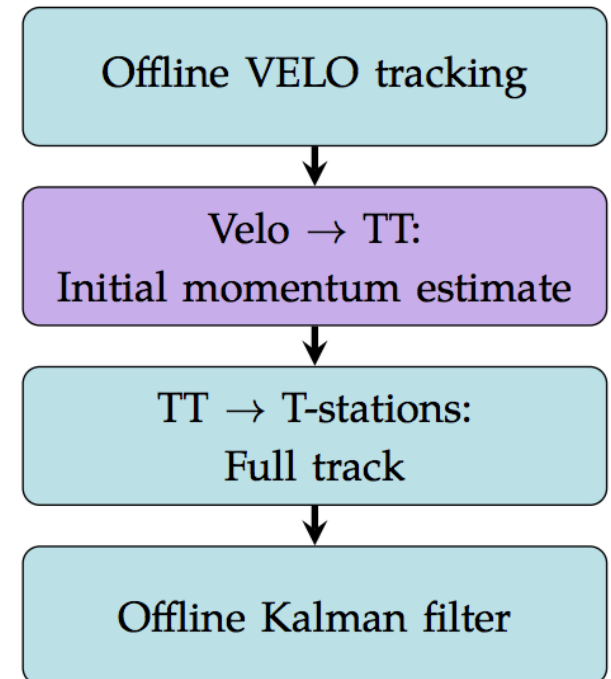

The new chain at work

- IP resolution comparable with 2012 data
- Stable between different fills
- Compatible results with 50 and 25 ns data

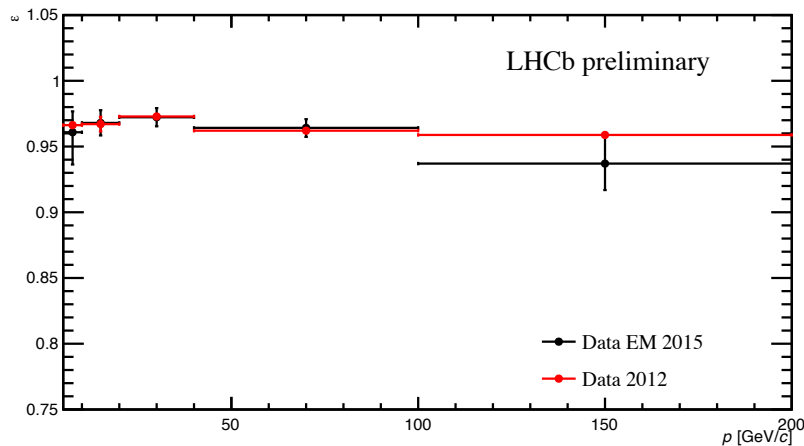
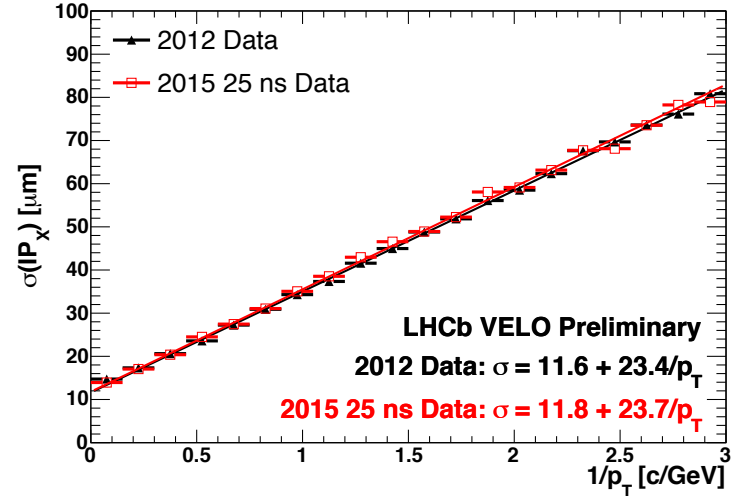

Tracking efficiency comparable with 2012 data

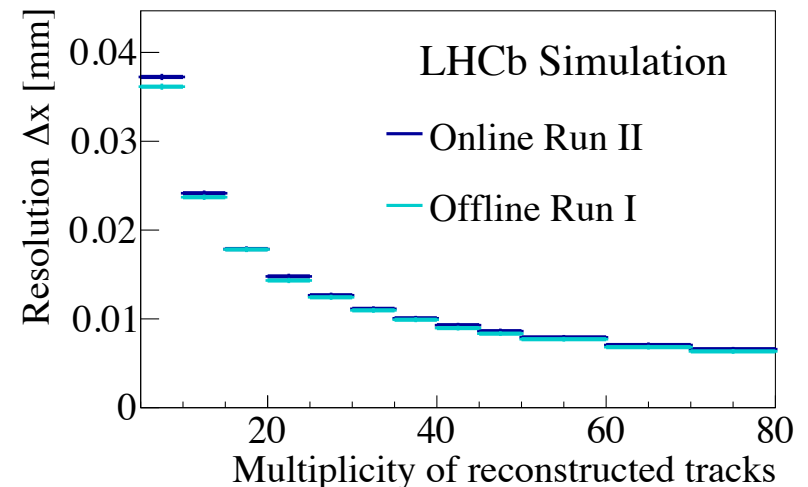

Identical resolution to Run I for the PV reconstruction with 70% smaller fraction of fake primary vertices

Still a difficult challenge:

- ~~Managing to do the full reconstruction in ... achieving offline performance (same or better than in Run1):~~ **DONE!**
- Managing to do the full alignment and calibration of the detectors in real-time
- Being able to select efficiently many signals already at trigger level

Real-time alignment and calibration



Importance of the alignment (I)

- Physics performance relies on the spatial alignment of the detector and the accurate calibration of its subcomponents:
 - Accurate alignment of the VELO essential for primary vertices discrimination, excellent impact parameter (IP) and proper time resolution

IP_x resolution vs 1/p_T

First alignment

σ_{IP} (high p_T) = **14.0 μm**

Latest alignment

σ_{IP} (high p_T) = **11.6 μm**

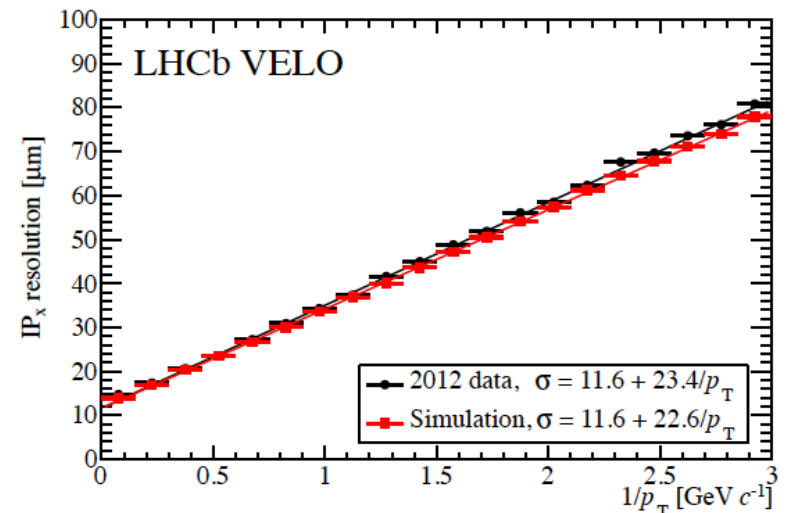
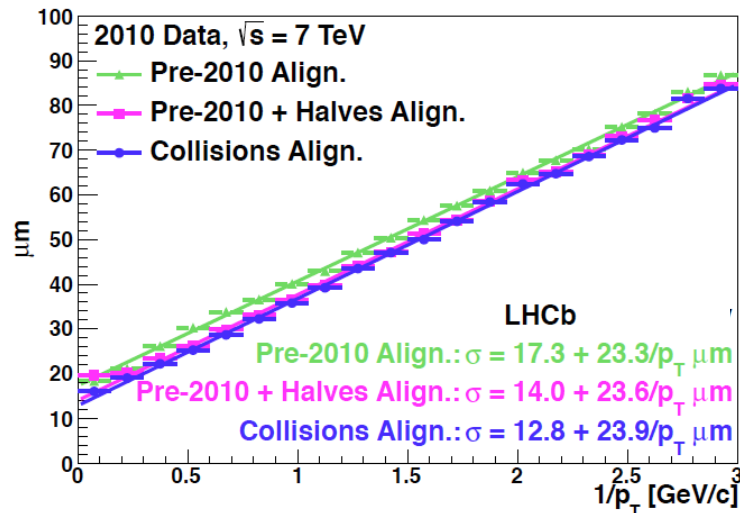

Importance the alignment (II)

- Physics performance relies on the spatial alignment of the detector and the accurate calibration of its subcomponents:
 - Better alignment of the tracking system improves the mass resolution

Invariant mass distribution for $\Upsilon \rightarrow \mu^+\mu^-$

First alignment

$$\sigma_{\Upsilon} = 92 \text{ MeV}/c^2$$

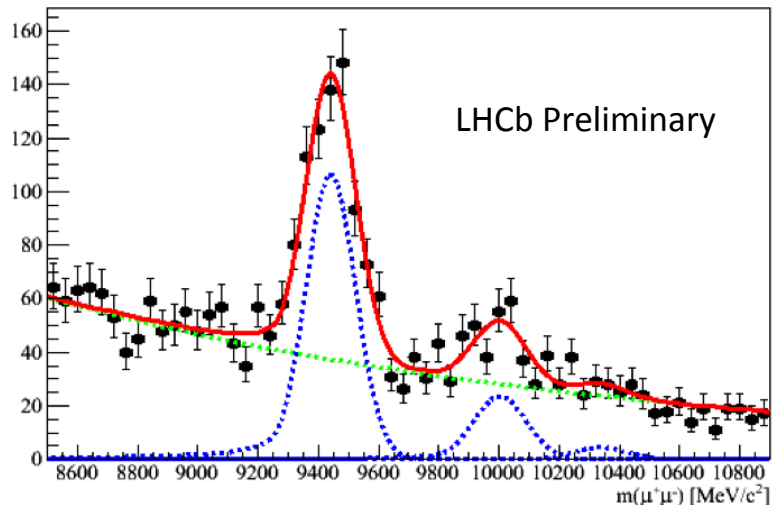

Better alignment

$$\sigma_{\Upsilon} = 49 \text{ MeV}/c^2$$

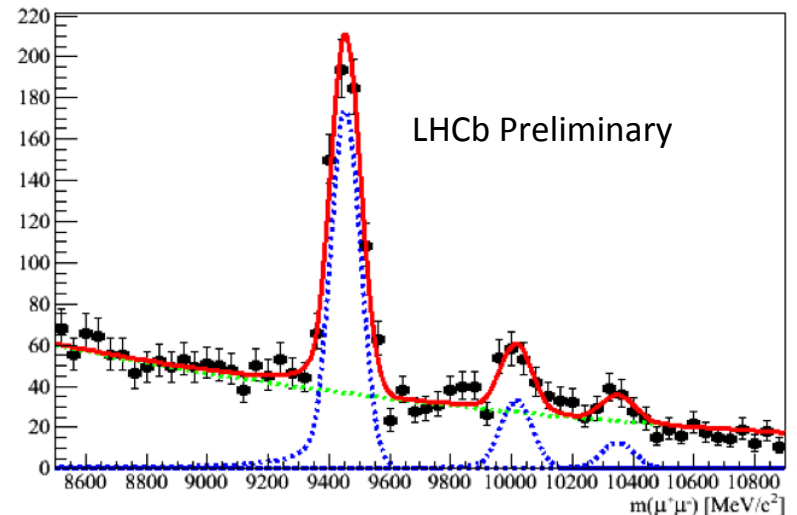

Importance of the calibration

- Complete calibration of the RICH detectors needed for exclusive selection using hadron particle identification criteria

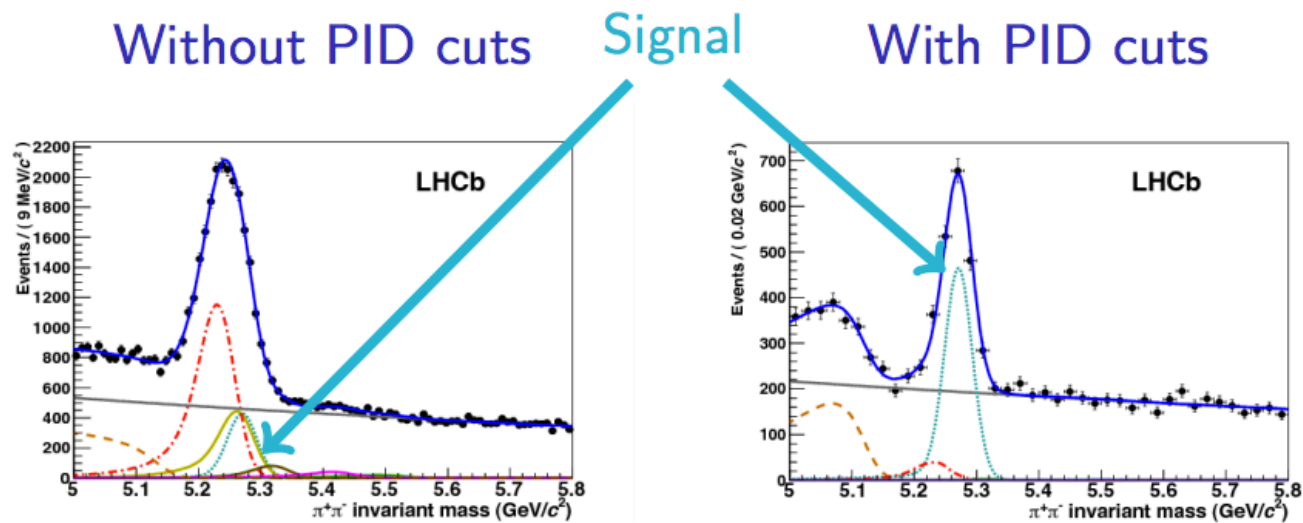

Invariant mass distribution for $B^0 \rightarrow \pi\pi$ decay ($B^0 \rightarrow \pi\pi$, $B^0 \rightarrow K\pi$,
 $B^0 \rightarrow 3\text{-bodies}$, $B_s \rightarrow KK$, $B_s \rightarrow K\pi$, $\Lambda_b \rightarrow pK$, $\Lambda_b \rightarrow p\pi$)

Real-time Alignment and Calibration(I)

- General Strategy
 - Automatic evaluation at regular intervals, e.g. per fill or per run depending on the task
 - Dedicated data sample to perform alignment or calibration collected with specific trigger selection line for each task
 - Compute the new alignment or calibration constants in **few minutes**
 - Update the constants only if needed
 - **The same new alignment and calibration constants will be used both by the trigger and the offline reconstruction**

Advantages:

- Have the same performance online and offline
- More effective trigger selection
- Stability of the alignment quality, hence physics performance
- Some analysis performed directly on the trigger output

Real-time Alignment and Calibration(II)

- Technicalities:
 - Constants expected to change: updated in real-time (each fill, run, ...)
 - Constants expected to be stable: monitoring
 - Took advantage of the farm computing power

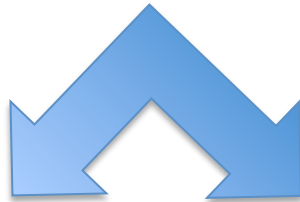

Calibration Farm tasks:

- RICH refractive index and HPD image calibration
- Calorimeter calibration
- OT- t_0 calibration

Online Farm tasks:

- VELO and tracker alignment
- Muon alignment
- RICH mirror alignment
- Calorimeter π^0 calibration

Real-time Alignment and Calibration(II)

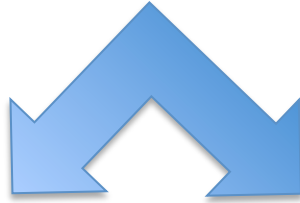

Calibration Farm

Online Farm

- Tasks are run on a single node
- Evaluation of the parameters by fitting online-monitoring histogram

Real-time Alignment and Calibration(II)

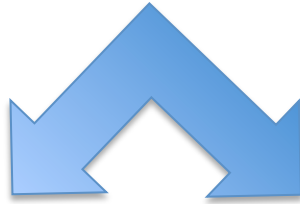

Calibration Farm

- Tasks are run on a single node
- Evaluation of the parameters by fitting monitoring histogram

Online Farm

- Parallel processing **on ~1700 HLT farm nodes**
- Evaluation of the parameters by iterative process
 - Analyser (multiple nodes): perform reconstruction
 - Combination of output, fits/ minimization -> extract constants

Real-time Alignment and Calibration(II)

- Technicalities:
 - Constants expected to change: updated in real-time (each fill, run, ...)
 - Constants expected to be stable: monitoring
 - Took advantage of the farm computing power

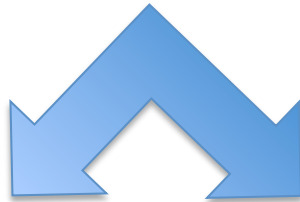

Calibration Farm tasks:

- RICH refractive index and HPD image calibration
- Calorimeter calibration
- OT- t_0 calibration

Online Farm tasks:

- VELO and tracker alignment
- Muon alignment
- RICH mirror alignment
- Calorimeter π^0 calibration

VELO, Tracker and Muon alignment: logic

- ✧ Uses an iterative procedure to minimise the residuals of a Kalman fit to a sample of reconstructed tracks
- ✧ Multiple scattering and magnetic field are taken into account and both particle masses and information from vertices are used as global constraints

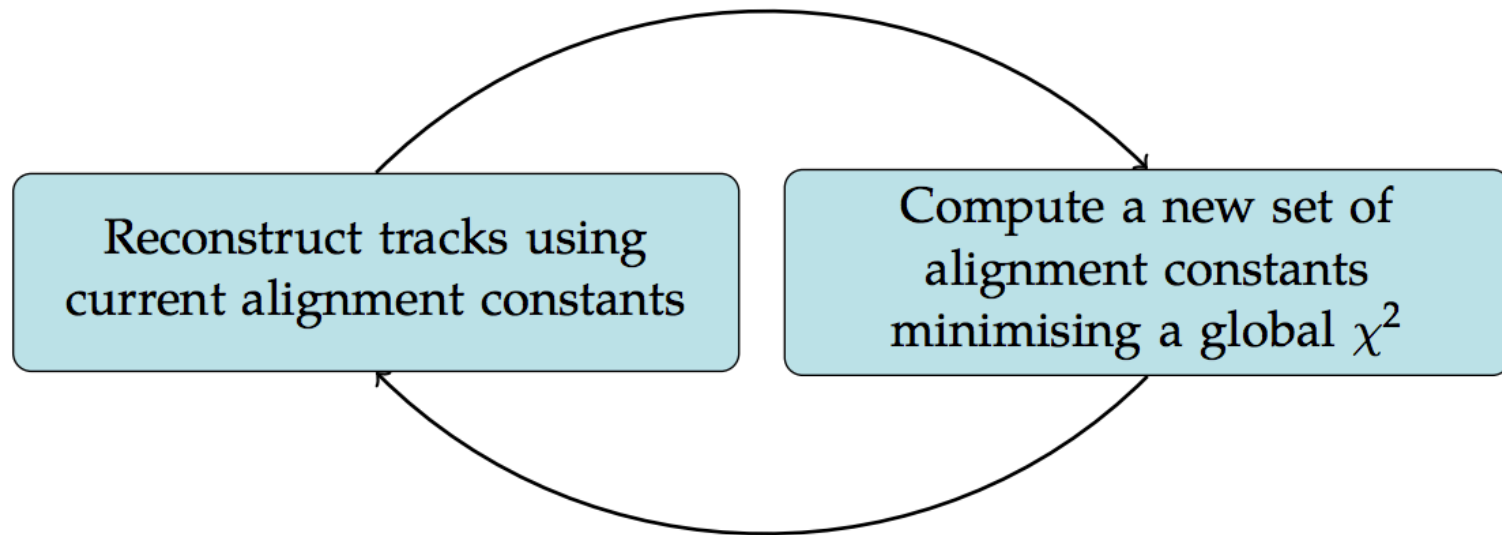

Iterate until χ^2 difference is below threshold

VELO, Tracker and Muon alignment: at work

- Automatic alignment procedure runs at the start of each fill
 - ➔ update of the constants only if necessary
 - **VELO**: is opened and closed every few fills.
 - Expected to update constants every few fills
 - **Tracking systems (TT, IT, OT)**
 - Expected to update constants every few weeks
 - **Muon system**
 - Only as monitoring (expected only after hardware interventions to the system)

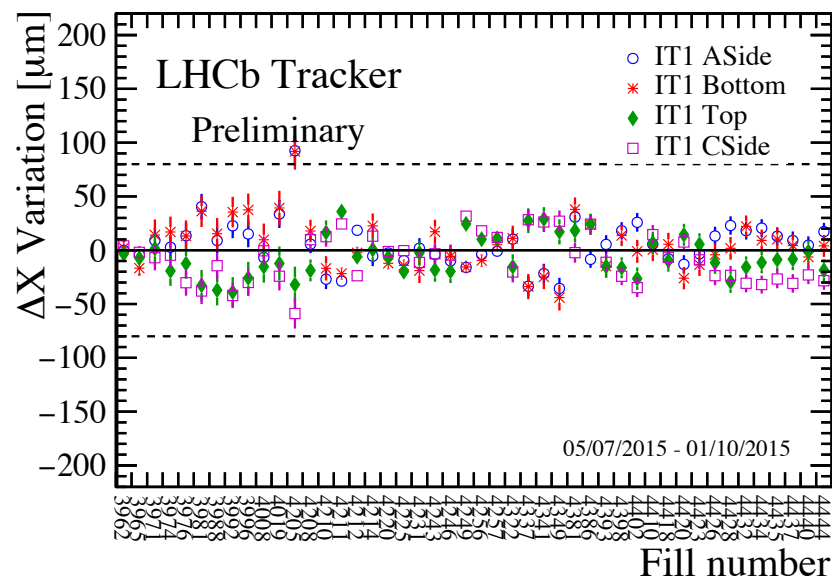
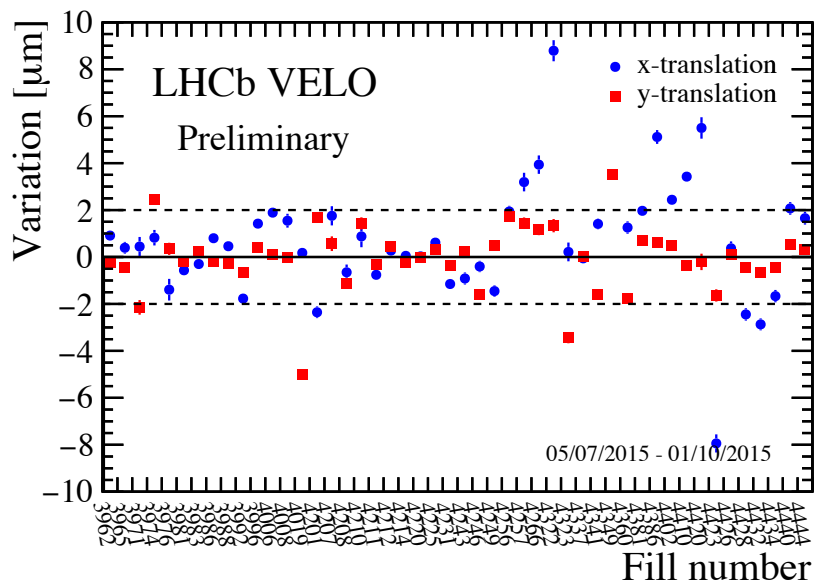

VELO, Tracker and Muon alignment: Run I vs Run II

Run I

- Run offline few times per year (and updated online)
- Time needed to run offline ~1h
- Data taken with a previous version of the alignment -> not best conditions used in HLT
- New alignment updated offline for the re-processing of the data

Run II

- **Run every fill and constants automatically updated**
- Time needed **~7 minutes**
- HLT always with the most updated constants
- Offline synchronized with online parameters

Real-time Alignment and Calibration(II)

- Technicalities:
 - Constants expected to change: updated in real-time (each fill, run, ...)
 - Constants expected to be stable: monitoring
 - Took advantage of the farm computing power

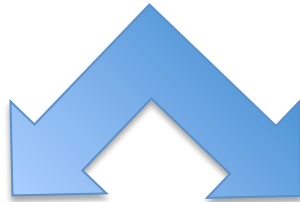

Calibration Farm tasks:

- RICH refractive index and HPD image calibration
- Calorimeter calibration
- OT- t_0 calibration

Online Farm tasks:

- VELO and tracker alignment
- Muon alignment
- RICH mirror alignment
- Calorimeter π^0 calibration

RICH Mirror alignment: logic

- Cherenkov photons focused on photon-detector plane by spherical and flat mirrors
- An imaginary track reflected through the RICH mirrors should be in the center of the Cherenkov ring
- The distribution of the $\Delta\theta$ against φ results in a sinusoidal distribution in case of misalignment of the mirrors
- Fit the distribution to calculate alignment constants

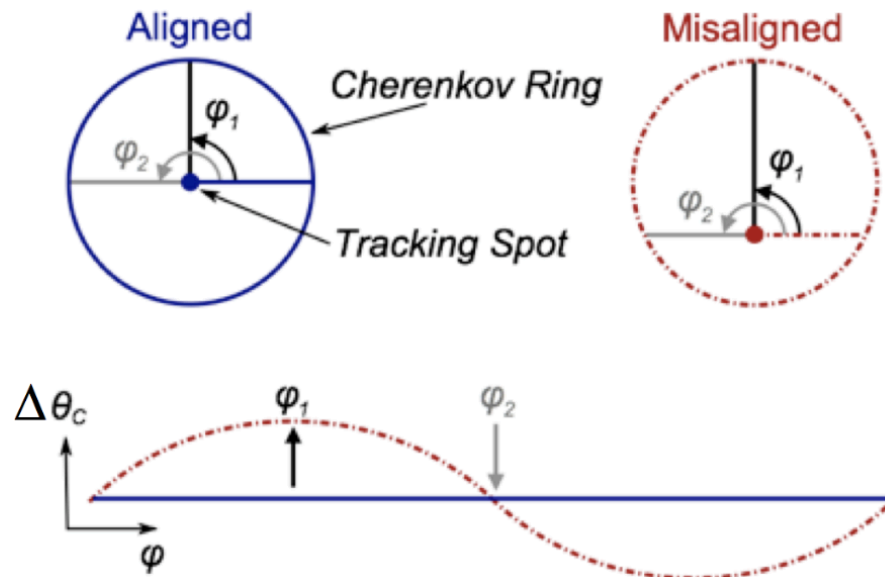

RICH mirror alignment: at work

- Mirror pairs to align:
 - RICH1: 16
 - RICH2: 94
- 1090 alignment constants
- **Re-optimization of the code** and HLT-selection of the high momentum tracks to be run in the online environment
- Same framework as the tracking alignment:
 - Analysers: photon reconstruction done in parallel
 - Iterator: fit of the $\Delta\theta$ distribution on a single node
- Used as monitoring (if enough statistics available potentially each fill)

Before alignment

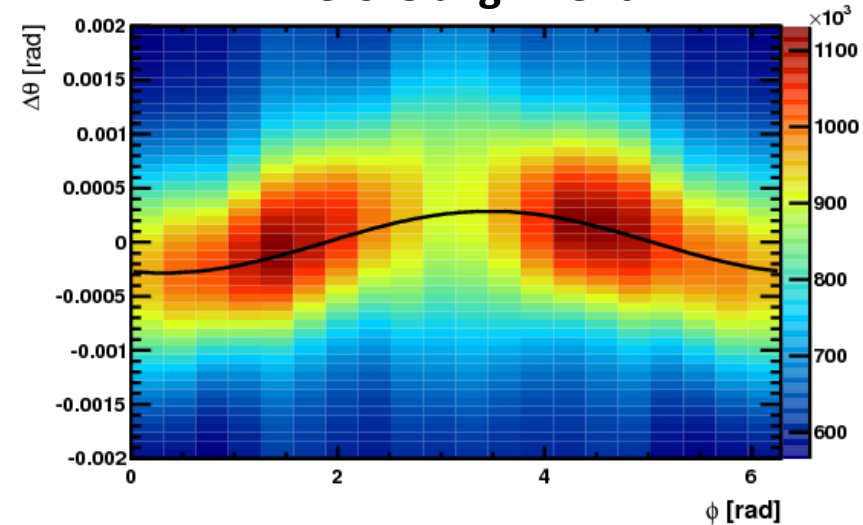

After alignment

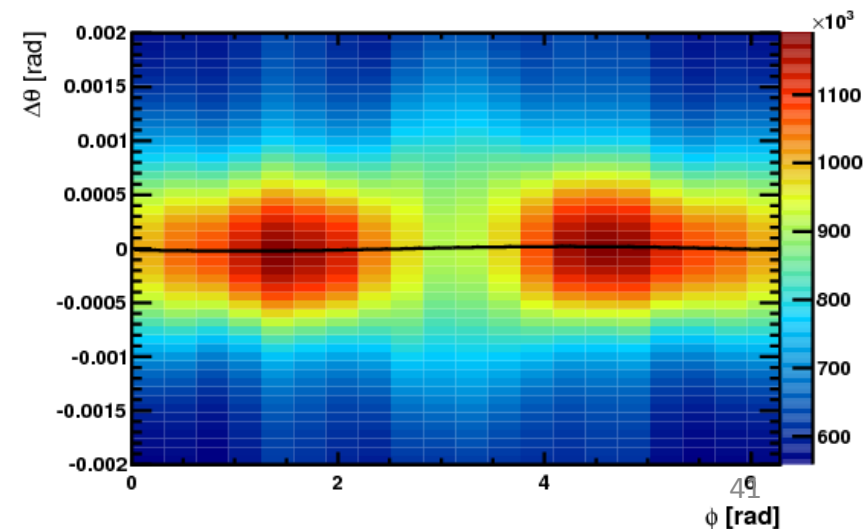

RICH mirror alignment: Run I vs Run II

Run I

- Run offline few times per year
- Time needed to run offline ~several days on the GRID
- Minimal usage of RICH information at HLT level (not fully calibrated system)
- New alignment updated offline for the re-stripping of the data

Run II

- Re-optimized code
- **Run as soon as enough statistics is accumulated (typically 1-2 fills)**
- Time needed **~30 minutes**
- RICH information can be used in HLT: fully calibrated system
- **Used as monitoring**

Real-time Alignment and Calibration(II)

- Technicalities:
 - Constants expected to change: updated in real-time (each fill, run, ...)
 - Constants expected to be stable: monitoring
 - Took advantage of the farm computing power

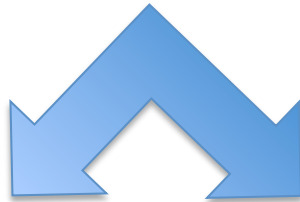

Calibration Farm tasks:

- RICH refractive index and HPD image calibration
- Calorimeter calibration
- OT- t_0 calibration

Online Farm tasks:

- VELO and tracker alignment
- Muon alignment
- RICH mirror alignment
- Calorimeter π^0 calibration

RICH calibration: logic

- RICH automatic calibration consists of calibrating:
 1. RICH refractive index:
 - Depends on the gas mixture, temperature and pressure
 - Determined by fitting the difference between reconstructed and expected Cherenkov angle

Before alignment

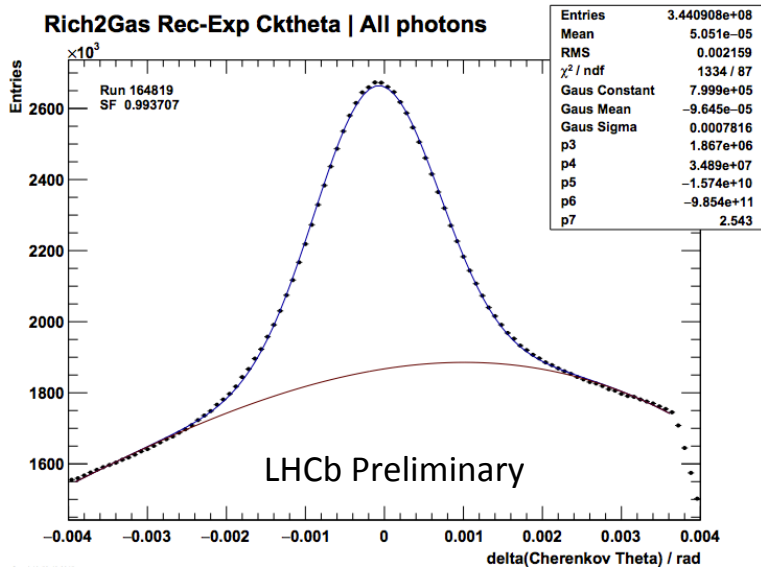

After alignment

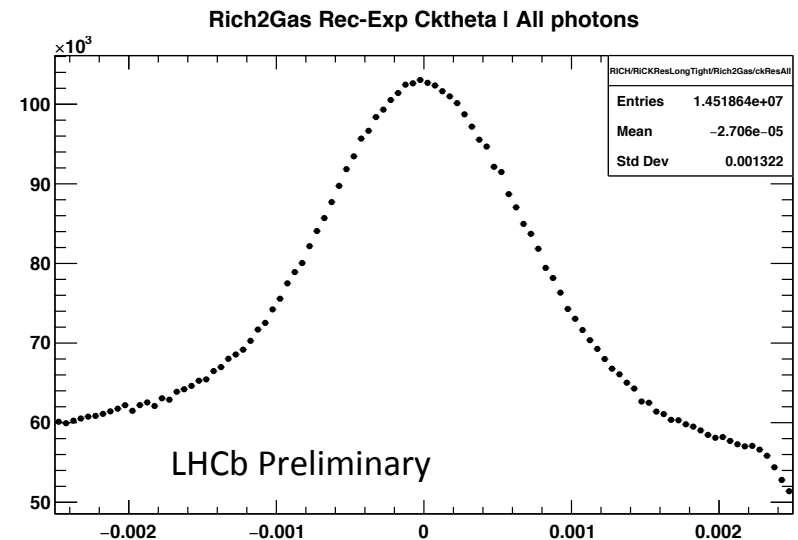

RICH calibration: logic

- RICH automatic calibration consists of calibrating:
 1. Silicon strip detector (SSD) images
 2. Hybrid photon detector (HPD) images
 - Affected by the magnetic and electric fields distortions
 - Anode images cleaned and Sobel filter is used to detect the edges

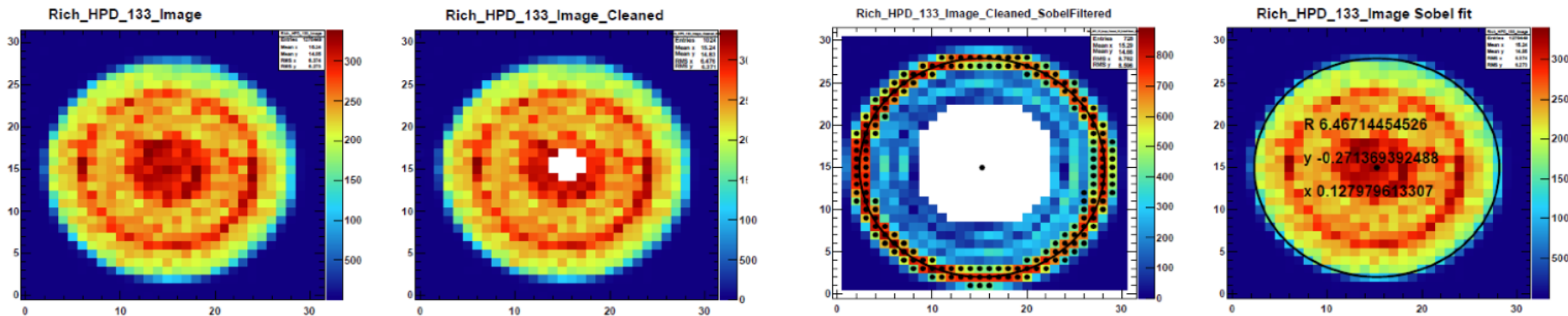

RICH calibration: at work

Fully automatic procedure, evaluated run by run

- In case of a too short run, the same constants of the previous run are used
- Calibration parameters are monitored by PVSS trend plots
- Maintained stable conditions during 2015 data taking

RICH 1

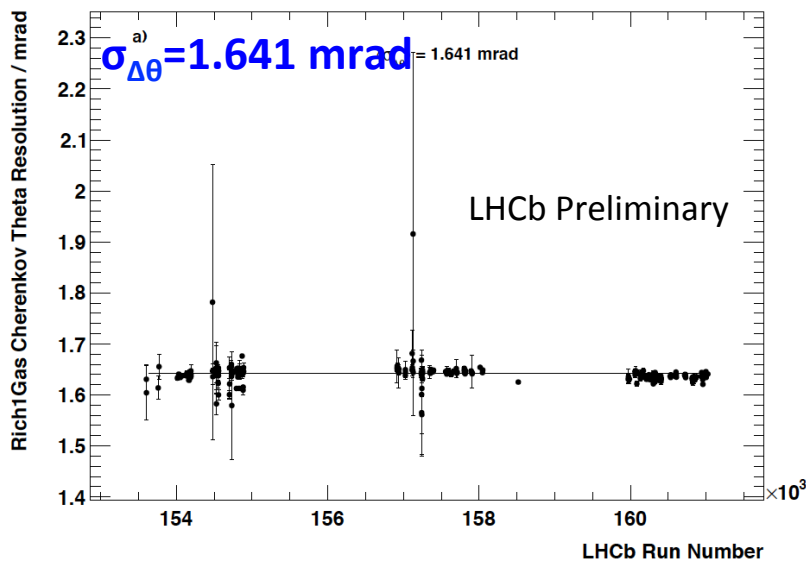

RICH 2

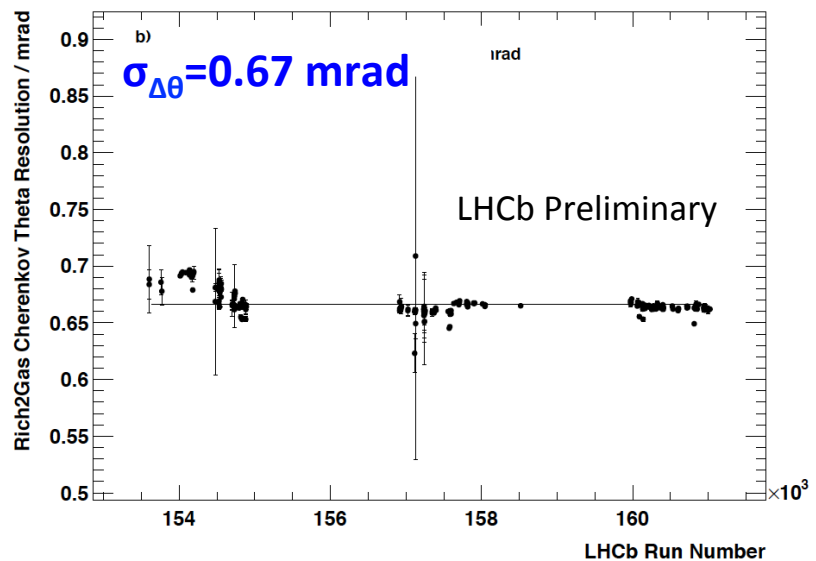

Real-time Alignment and Calibration(II)

- Technicalities:
 - Constants expected to change: updated in real-time (each fill, run, ...)
 - Constants expected to be stable: monitoring
 - Took advantage of the farm computing power

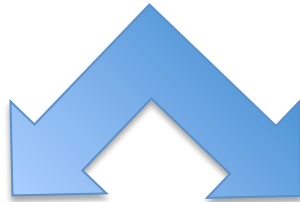

Calibration Farm tasks:

- RICH refractive index and HPD image calibration
- Calorimeter calibration
- OT- t_0 calibration

Online Farm tasks:

- VELO and tracker alignment
- Muon alignment
- RICH mirror alignment
- Calorimeter π^0 calibration

Calorimeter calibration: logic

- Important to have stable L0 rates
- It allows to account for ageing effects
- The calibration adjust directly the HV settings

- Absolute calibrations:
 - π^0 calibration:
 - Selected photons (3x3 clusters) and fix seed (central) cell
 - Compute di-photon invariant mass
 - Find the coefficient which would move the measurement closer to the nominal π^0 mass
 - Cs source scan:
 - Scan of the response with the source. Done each TS
- Relative calibrations:
 - Raw occupancy method:
 - Comparison of the performance of each cell with a reference
 - LED monitoring system:
 - To detect ageing of the PMTs

Calorimeter calibration: at work

- The LED corrections for ECAL and HCAL are automatically performed/updated every fill
 - ~15 minutes to have the corrections available
- Commissioning of the occupancy method ongoing: waiting for stable beam conditions (not available in Run1)
- π^0 calibration done every months: now it takes only few hours to produce the results

LED average over 456 cells in the very central part of ECAL

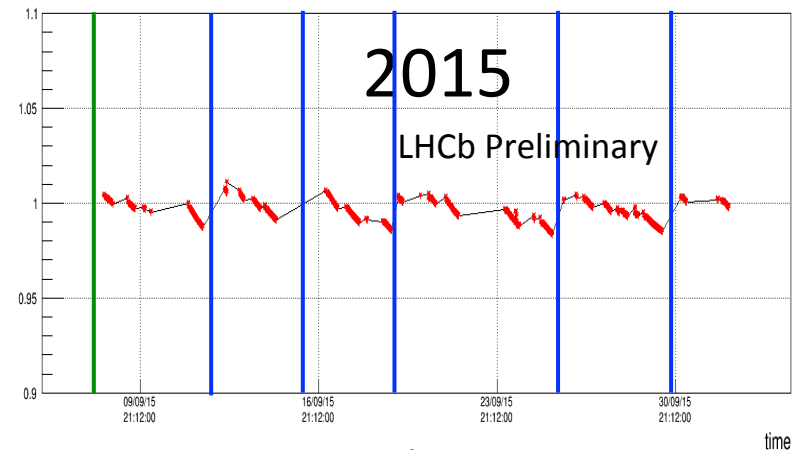
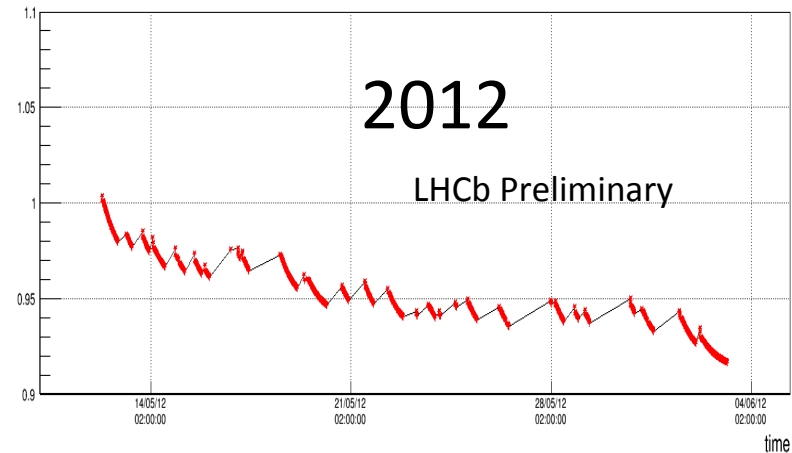

2012 – no corrections

2015: green line – π^0 based calibration; blue lines – LED based corrections

π^0 -calibration

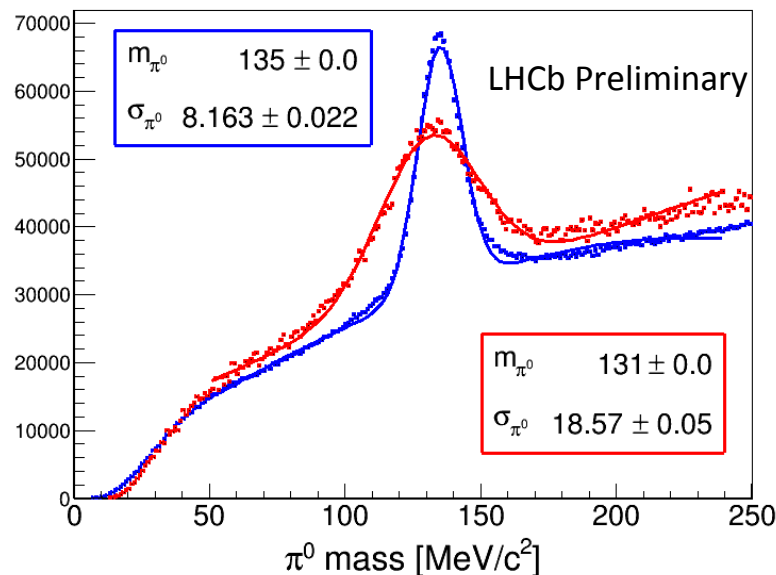

Real-time Alignment and Calibration(II)

- Technicalities:
 - Constants expected to change: updated in real-time (each fill, run, ...)
 - Constants expected to be stable: monitoring
 - Took advantage of the farm computing power

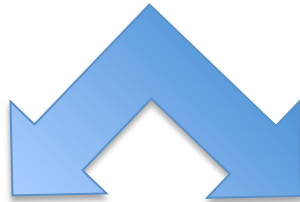

Calibration Farm tasks:

- RICH refractive index and HPD image calibration
- Calorimeter calibration
- OT- t_0 calibration

Online Farm tasks:

- VELO and tracker alignment
- Muon alignment
- RICH mirror alignment
- Calorimeter π^0 calibration

OT- t_0 calibration: logic

[JINST 9 \(2014\) P01002](#)

- Global time offset (t_0) related to the synchronization between the OT time and the collision time -> a shift of 0.5 ns leads to tracking inefficiency of $\sim 0.25\%$
- Calculate t_0 for the entire OT (real-time update)
- The offset is evaluated by using the reconstructed tracks, and comparing the drift time with the expected drift time (evaluated using the TR-relation)

$$\Delta t = t_{\text{meas}} - t(r)$$

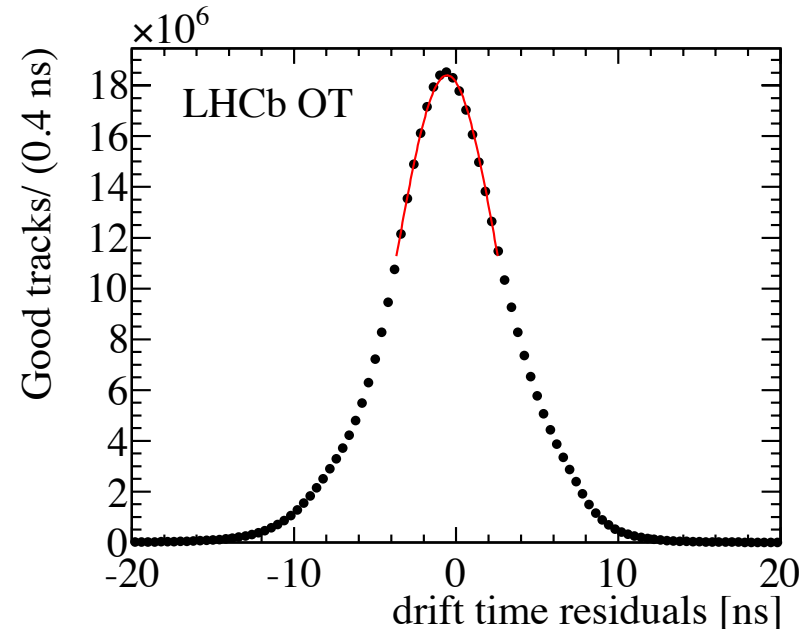
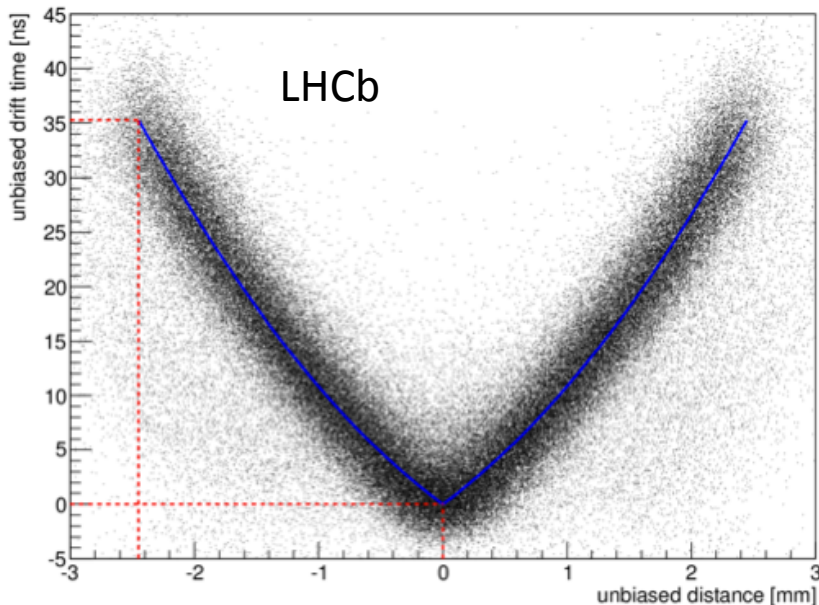

OT-t0 calibration: at work

- Executed every fill, update expected every few weeks
- Automatic evaluation and update of the constants worked from day one!!!
- Added for monitoring purpose the t0-calibration per chip (4-each module).

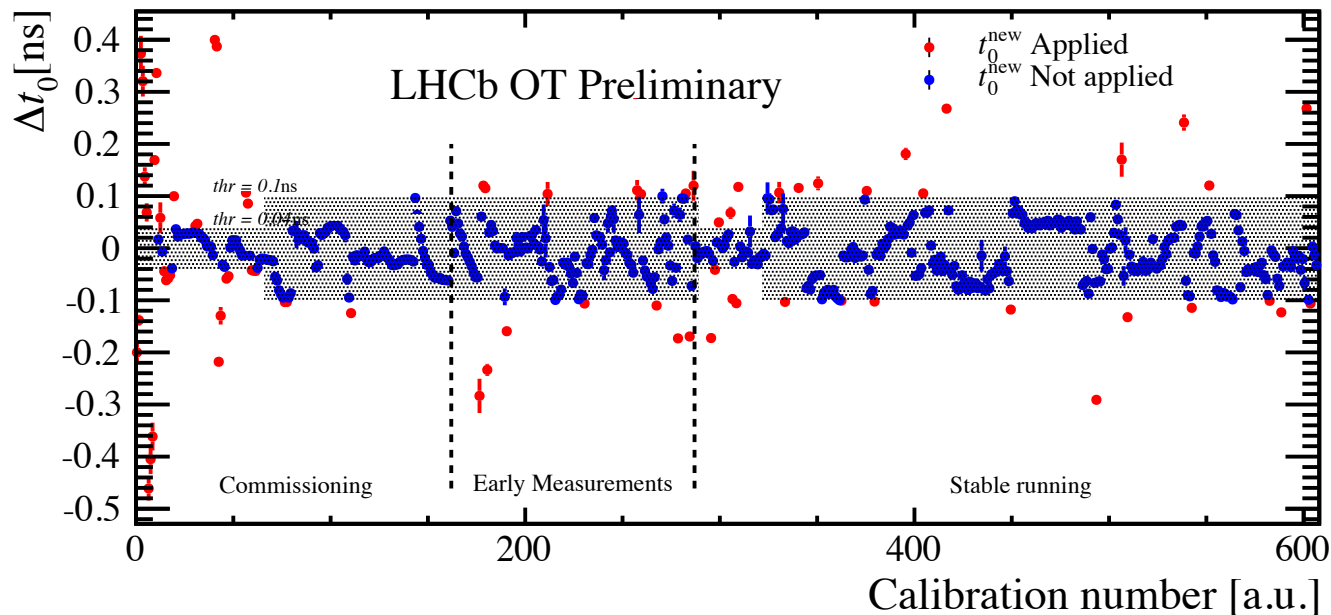

Still a difficult challenge:

- ~~Managing to do the full reconstruction in ... achieving offline performance (same or better than in Run1):~~ **DONE!**
- ~~Managing to do the full alignment and calibration of the detectors in real-time:~~ **DONE!**
- Being able to select efficiently many signals already at trigger level

Selection power at trigger level

- Same reconstruction as offline and complete alignment and PID calibration allows to apply a tighter selection on kinematics quantities
- RICH calibration allows to use hadron particle identification in selection, e.g. boost efficiency for Cabibbo suppressed decays while keeping the rate low by pre-scaling the Cabibbo favored counterpart

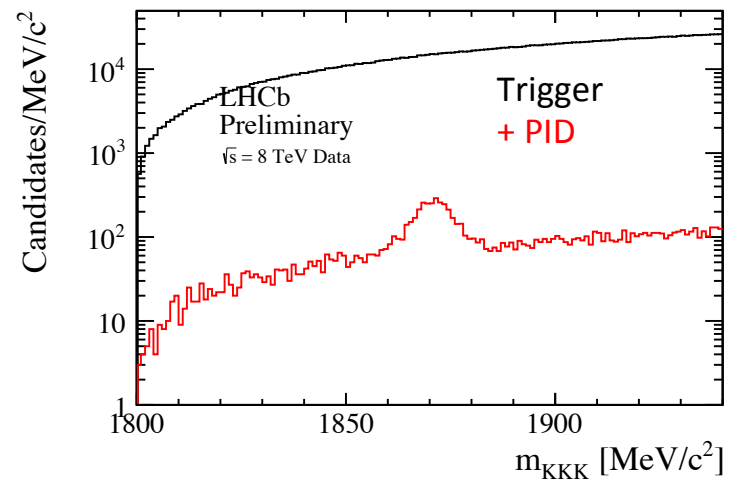
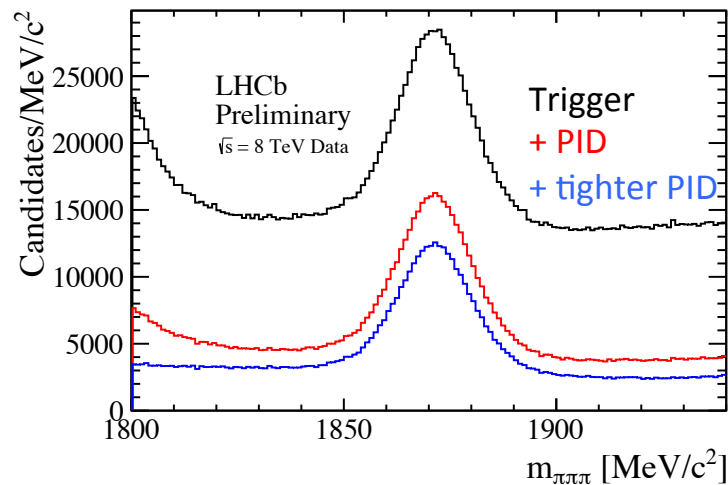

Still a difficult challenge:

- ~~Managing to do the full reconstruction in ... achieving offline performance (same or better than in Run1):~~ **DONE!**
- ~~Managing to do the full alignment and calibration of the detectors in real-time:~~ **DONE!**
- ~~Being able to select efficiently many signals already at trigger level:~~ **DONE!**

Ready to do physics from the HLT output!

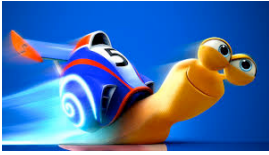

The TURBO Stream

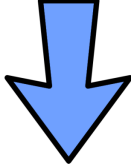
- Store HLT candidate information
 - Remove detector raw data
 - Save ~90% of space
- 
- Idea for analysis with large yields: possible to reduce the pre-scaling of all the channels that were trigger output rate constraint -> **more physics possible!**
 - ~24h turn-around from data taking to analysis
 - Real challenge relying on the good operational performance: no 2nd chance of reprocessing to fix problems

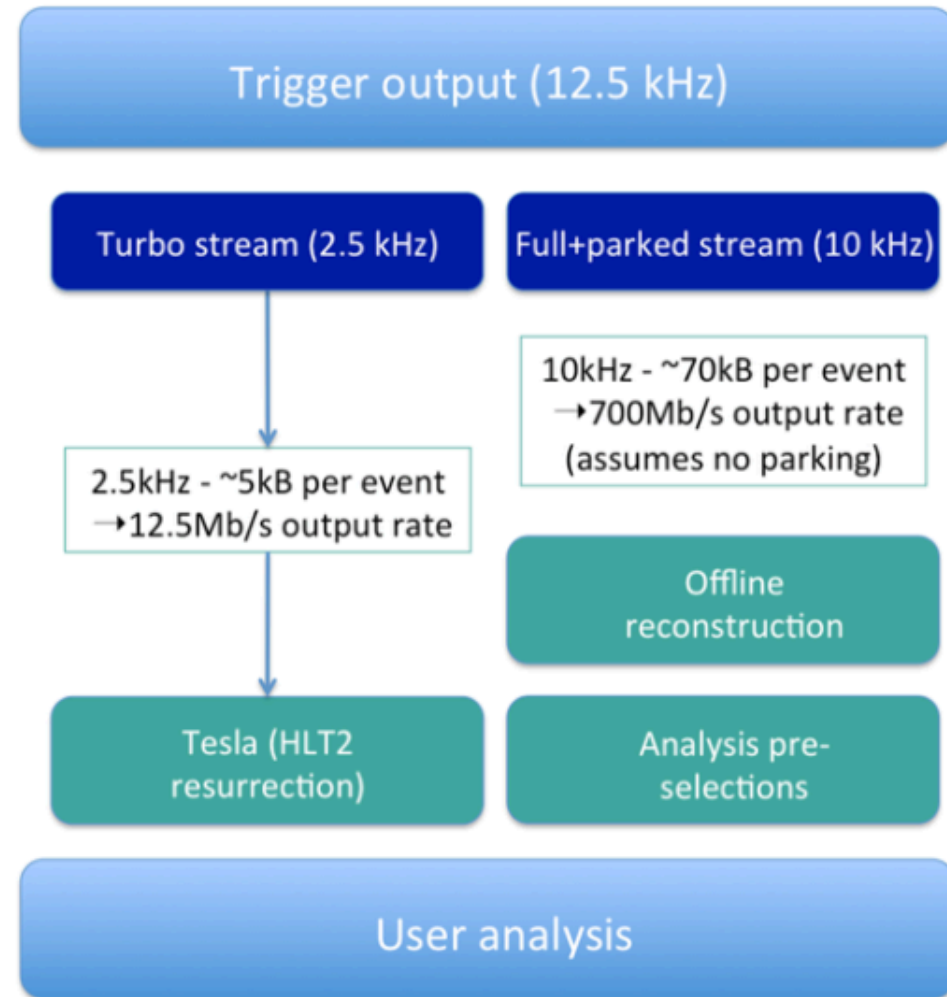

The TURBO Stream at work: the early measurements

More material on
the [talk](#) of Patrick
Spradlin Wednesday
7th October!

Used for early measurement cross-section

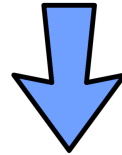

Results presented **1 week** after their acquisition!

Example J/ψ cross-section

[ArXiv 1509.00771](#) accepted by JHEP

- The trigger found 10^6 $J/\psi \rightarrow \mu^+\mu^-$ in $3.03 \pm 0.12 \text{ pb}^{-1}$ with J/ψ $p_T < 14 \text{ GeV}/c$ and $2 < \gamma < 4.5$
- No offline processing: mass resolution of $\sim 12 \text{ MeV}/c^2$ compatible with Run1 data

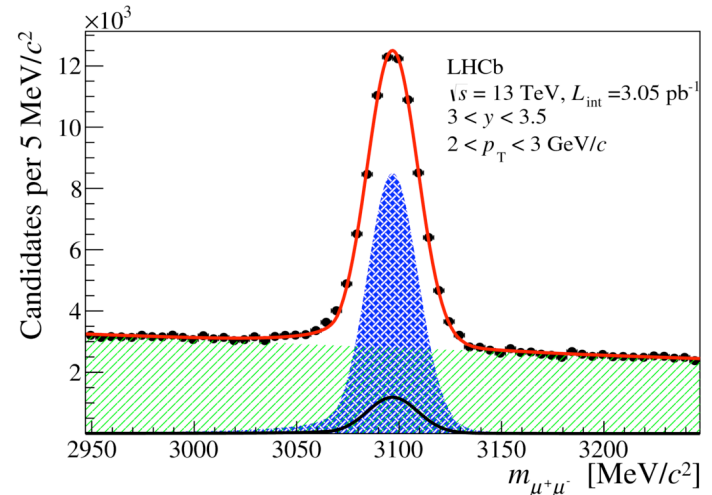

Luminosity measurement

- In LHCb two techniques used to measure the luminosity:
 - **Traditional Van der Meer scans:** with LHC moving the beams with respect to each other in small steps
 - **Beam Gas Imaging Method** with SMOG to reconstruct beam shape at the interaction point
- The combination of the two techniques allowed in Run1 to achieve the **best precise measurement** of the luminosity at LHC with **1.1%** of uncertainty [[JINST 9 \(2014\) 12, P12005](#)]
- Only beam gas imaging method available for the EM timescale
- Delivered a luminosity measurement with **3.8% of uncertainty in few weeks** (measurement 10th of June, first results presented at EPS the 22th of July)
- Further analysis to combine the two methods ongoing

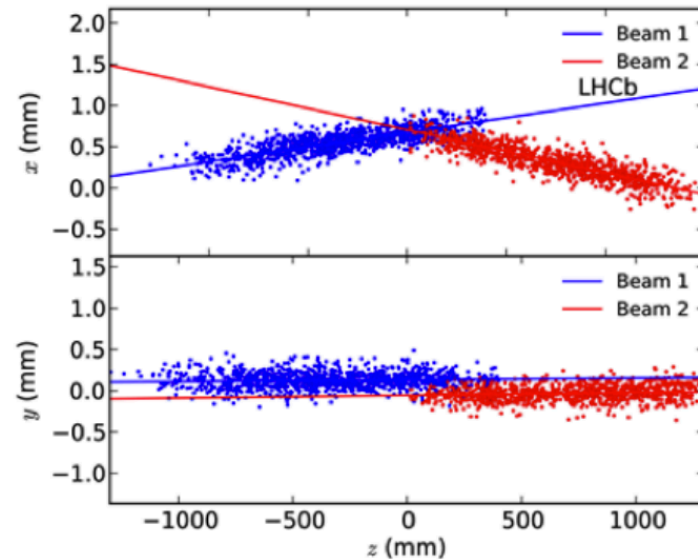

Only HLT1 is used for this measurement: the new HLT split allowed to write very fast data to disk increasing the precision of the measurement (~1%)

Conclusions

- **LHCb is the first HEP experiment with a full calibration, alignment and reconstruction done in real-time**
- Provided new calibration and alignment constants for each run or fill in **few minutes**
- Possible to monitor in few hours quantities that in Run I were monitored only few times in a year (like during TS)
- The Turbo Stream allowed to:
 - Increase the physics reach by saving more data in less space (important for high branching ratio channels)
 - Physics analysis doable ~24h after the data taking
- First measurement of the luminosity at 13TeV with only 3.8% of uncertainty (thanks to the Beam Gas Imaging Method) in few weeks from the data taking!
- First cross-section measurements presented at summer conferences one week after the data taking

Backup

The LHCb experiment

- LHCb is the dedicated heavy flavor physics experiment at LHC
- Its primary goal is to look for indirect evidence of new physics in CP-violation and rare decays of beauty and charms hadrons
- This requires:
 1. Excellent tracking (momentum, impact parameters and primary vertex resolution)
 2. Excellent decay time resolution
 3. Excellent particle identification

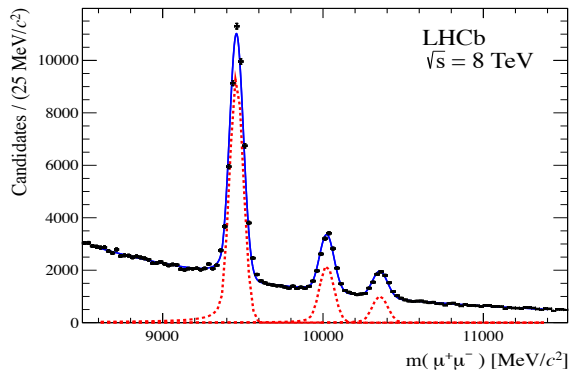

[JHEP 06 \(2013\) 064](#)

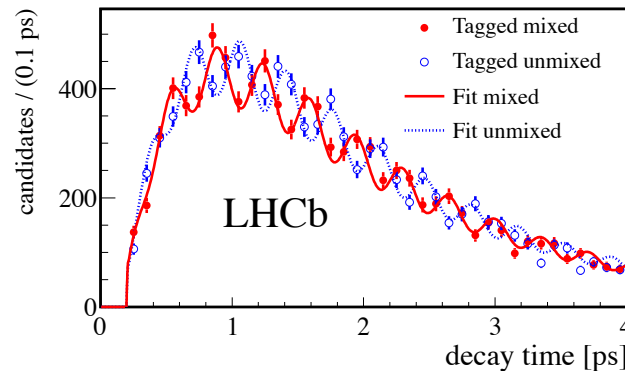

[New J.Phys. 15 \(2013\) 053021](#)

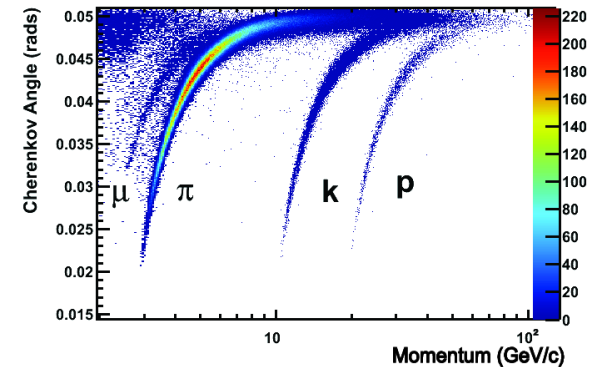

[Eur. Phys. J. C \(2013\) 73](#)

RICH1: easy!
 -> fix primary mirrors
 only align secondary mirrors

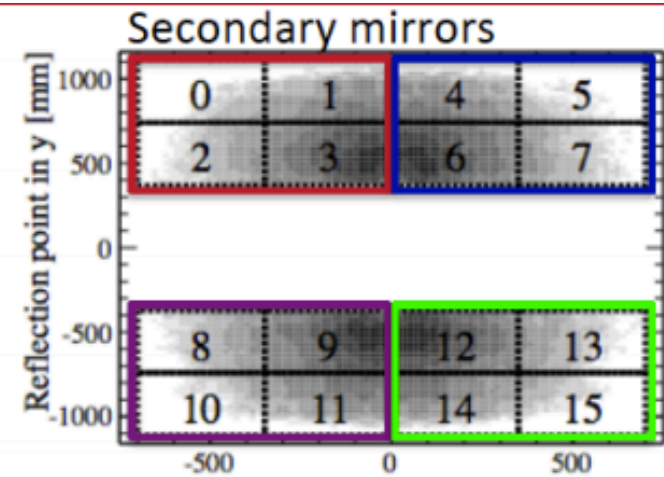
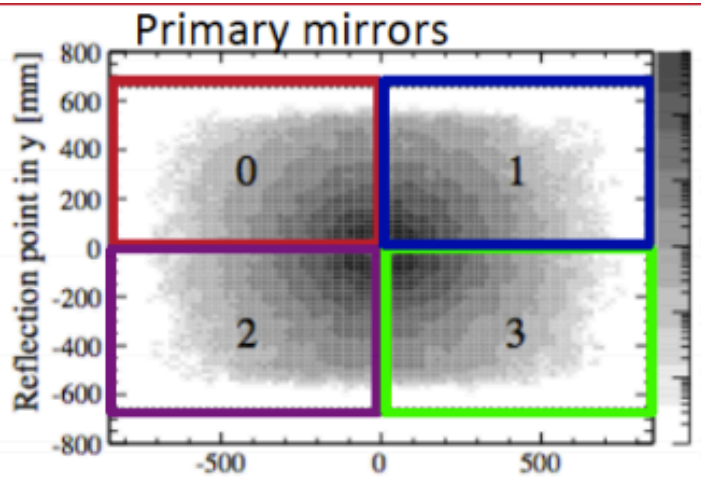

RICH2: more complicated
 For a given secondary mirror several primary mirrors possible -> solve a set of simultaneous equations per half of RICH2

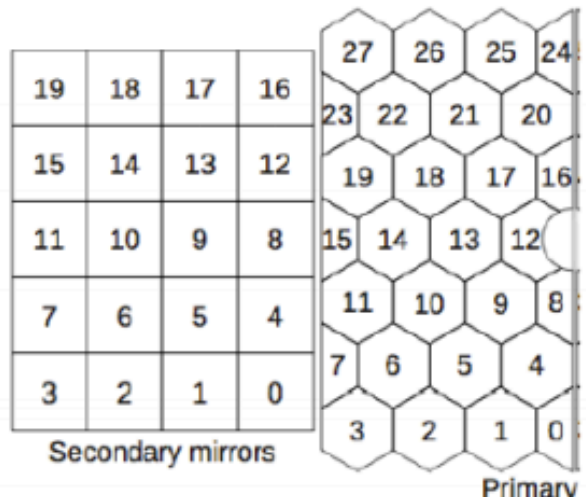

System of equations linking all primary mirrors (red) and secondary mirrors (grey).

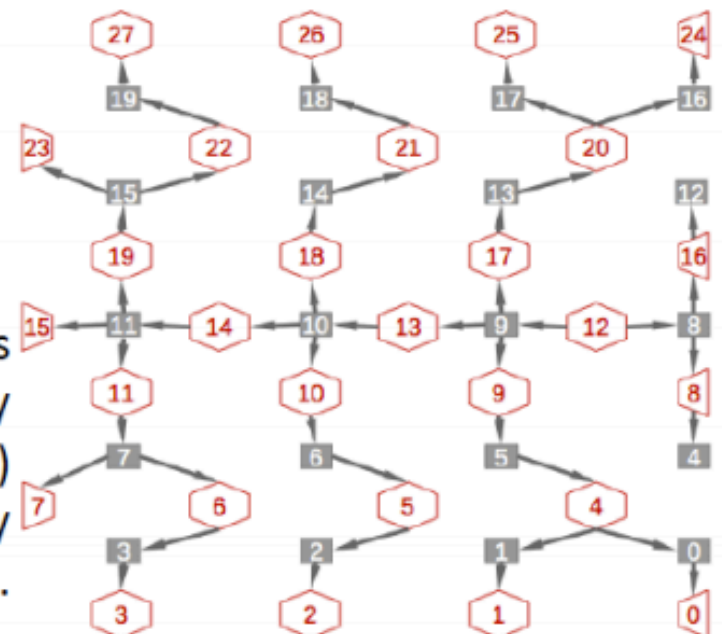

Trigger in RunII

- Events from lower trigger levels can be **buffered on disk while performing real-time alignment and calibration**
- Last trigger level uses the **same reconstruction as offline**
- **Same alignment and calibration constants** used by the trigger and the offline reconstruction
- Some analysis performed directly on the trigger output

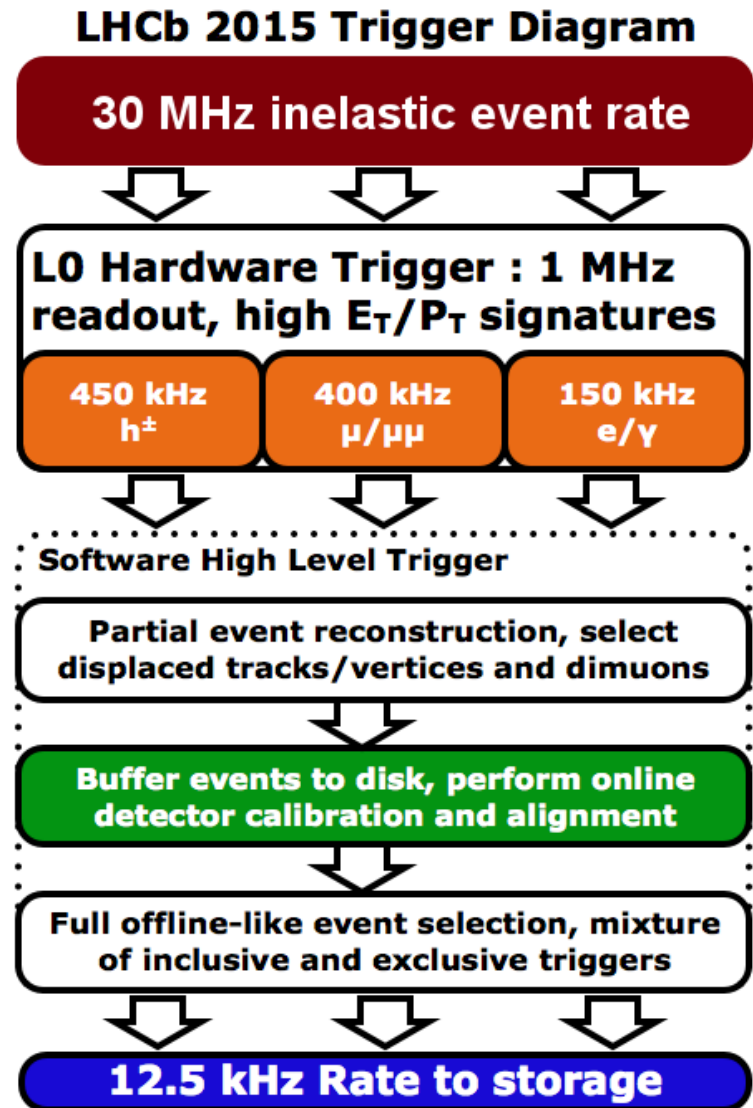

RICH calibration: logic

- RICH automatic calibration consists of calibrating:
 - RICH refractive index:
 - Depends on the gas mixture, temperature and pressure
 - Determined by fitting the difference between reconstructed and expected Cherenkov angle
 - Hybrid photon detector (HPD) images
 - Affected by the magnetic and electric fields distortions
 - Anode images cleaned and Sobel filter is used to detect the edges

Fully automatic procedure, evaluated run by run

- In case a too short run, the same constants of the previous run are used
- Calibration parameters are monitored by PVSS trend plots

Optimization of the reconstruction chain

- In order to maintain full reconstruction efficiency, while keeping within a strict timing budget many improvements were needed:
 - Optimization of the code (e.g. vectorization)
 - Changes to the reconstruction chain and optimization of the pattern algorithm

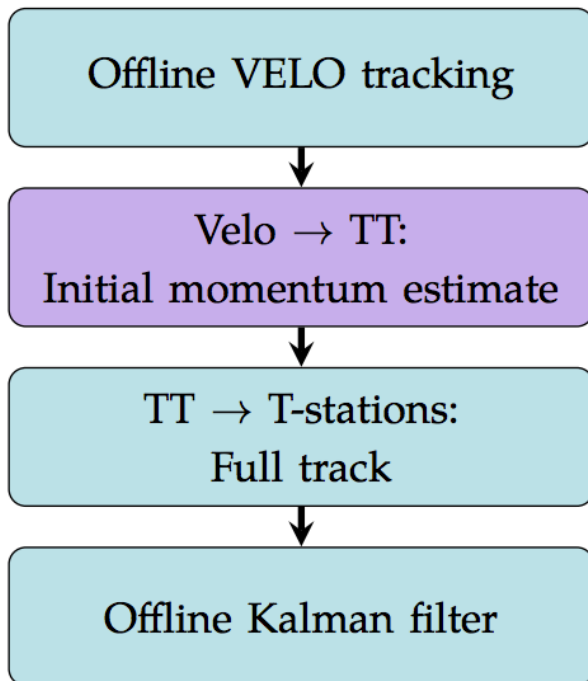

Example

- Improved sequence forming VeloTT tracks as an intermediate stage
- Availability of a momentum estimate to pre-select tracks at an early stage
- Charge estimate allows greatly reduced search windows downstream of the magnet
 - Factor of 4 less ghost rate
 - **Factor of 3 reduction in execution time**
- Tracks with a $p_T > 500 \text{ MeV}$ already available at **HLT1** level (in Run I $p_T > 1.3 \text{ GeV}$) **without any IP requirements needed.**

VeloTT algorithm

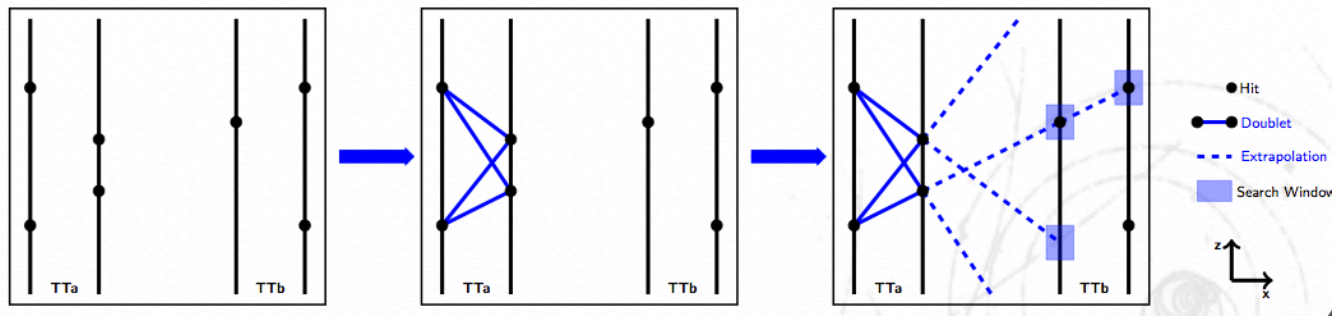

- Linearly extrapolate VELO track to TT
- Select hits within a search window around the extrapolated track
- Form doublets of hits in the first two layers
- Extrapolate doublets to third/fourth layers and search for compatible hits
- If no four hit candidates found, repeat in starting from last two layers
- Fit each track candidate with a χ^2 fit and estimate q/p ($\delta p/p \sim 15\%$)
- Choose best candidate track based on # layers fired and χ^2
- More than 97% efficiency for tracks with $p_T > 200\text{MeV}$ that hit at least 3 layers
 - Not total coverage of the LHCb acceptance by the TT detector: needed to recover tracks not leaving enough hits in the TT detector.

Calorimeter and Muon systems performance

Electron identification efficiency >91% with a hadron mis-identification fraction of few % $p > 10$ GeV/c (intermediate selection)

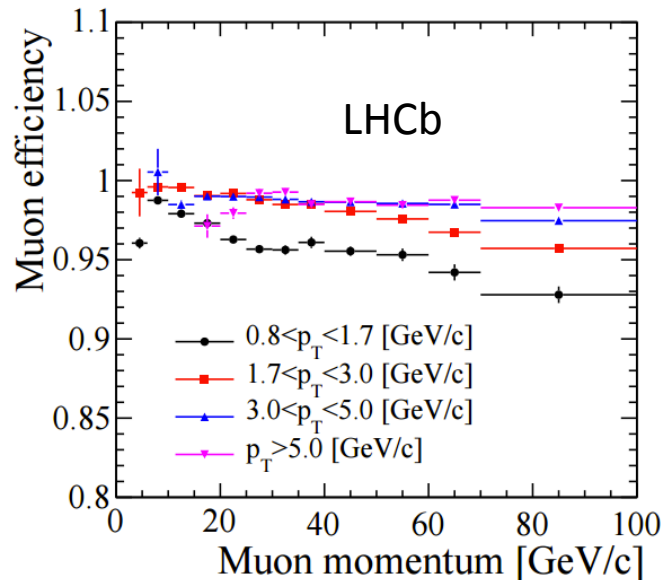
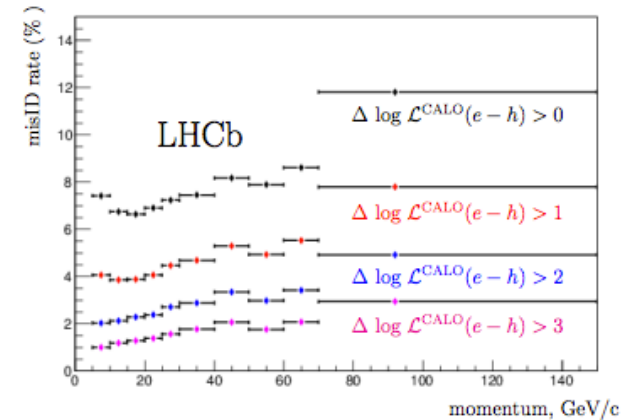
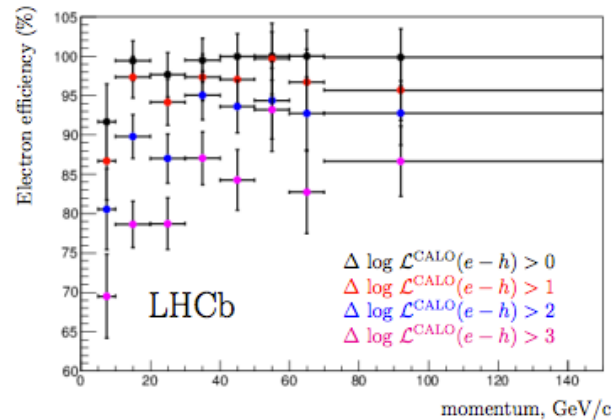

Muon efficiency >95% for almost all the p_T bins in the full momentum range

[Int.J.Mod.Phys. A30 \(2015\) 1530022](https://doi.org/10.1142/17513751550022)

The PID performances

Capability to distinguish particles (especially π -K) in a the momentum range 2-100 GeV/c

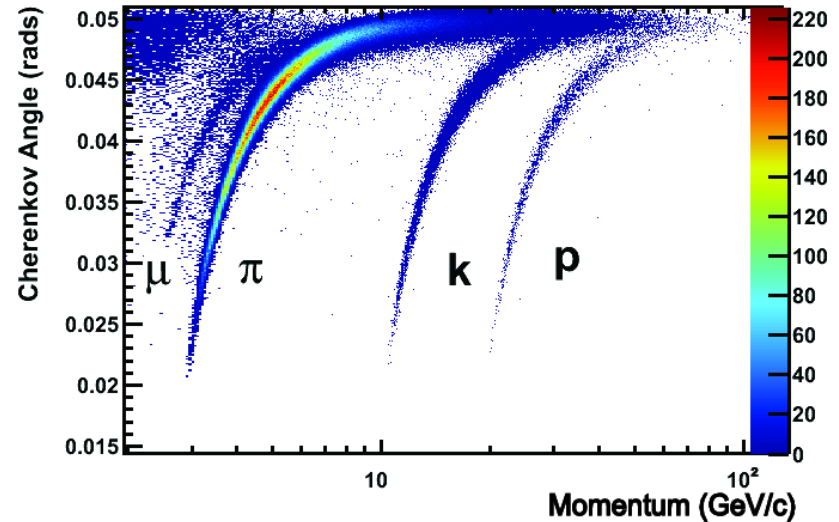
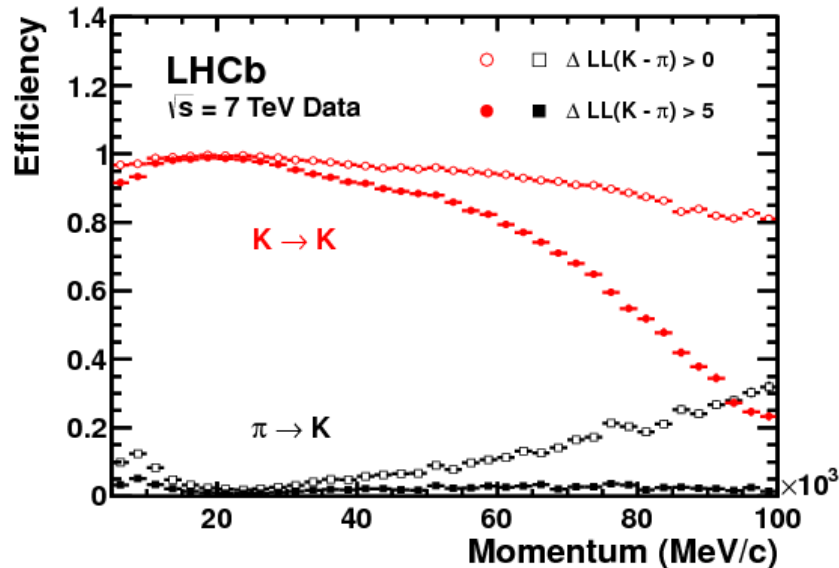

Kaon identification efficiency $\sim 95\%$ with a pion mis-identification fraction of $\sim 10\%$ over the full 2-100 GeV/c momentum range (tight selection)

[Eur.Phys.J. C73 \(2013\) 2431](#)

Server nodes

All servers in the EFF are dual-socket x86 servers. The overwhelming majority uses Intel processors but there are also a few AMD based systems. In the following tables some characteristics of these servers are given. All these servers are physically quad-servers, where 4 servers are installed in a single 2U chassis. They have between 1 and 2 GB of RAM per physical core.

	CPU type	Moore/s	SpecIntRate2006	number of physical cores	number of logical cores	total RAM	local harddisk space	number of units
DELL C6100	Intel x5650	650	36	12	24	24	2 TB	520
Action Solar 820 S4	Intel x5650	630	36	12	24	24	2 TB	400
ASUS RS720QA-E6-RS12	AMD 6272	680	32	23	32	32	2 TB	100
Intel S2600KP	Intel E5-2630v3	980	56	16	32	32	4 TB	800

Gain for b-physics

- Ratio of RunII over RunI for HLT2/HLT1 efficiencies. Note that the denominator is reconstructible with $p_T(B) > 2 \text{ GeV}$, $\tau(B) > 0.2 \text{ ps}$

mode	2.5 kHz
$B^0 \rightarrow K^*[K^+\pi^-]\mu^+\mu^-$	1.64
$B^+ \rightarrow \pi^+K^-K^+$	1.59
$B_s^0 \rightarrow D_s^-[K^+K^-\pi^-]\mu^+\nu_\mu$	1.14
$B_s^0 \rightarrow \psi(1S)[\mu^+\mu^-]K^+K^-\pi^+\pi^-$	1.62
$B_s^0 \rightarrow D_s^-[K^+K^-\pi^-]\pi^+$	1.46
$B^0 \rightarrow D^+[K^-\pi^+\pi^+]D^-[K^+\pi^-\pi^-]$	1.40

Tracking efficiency from data

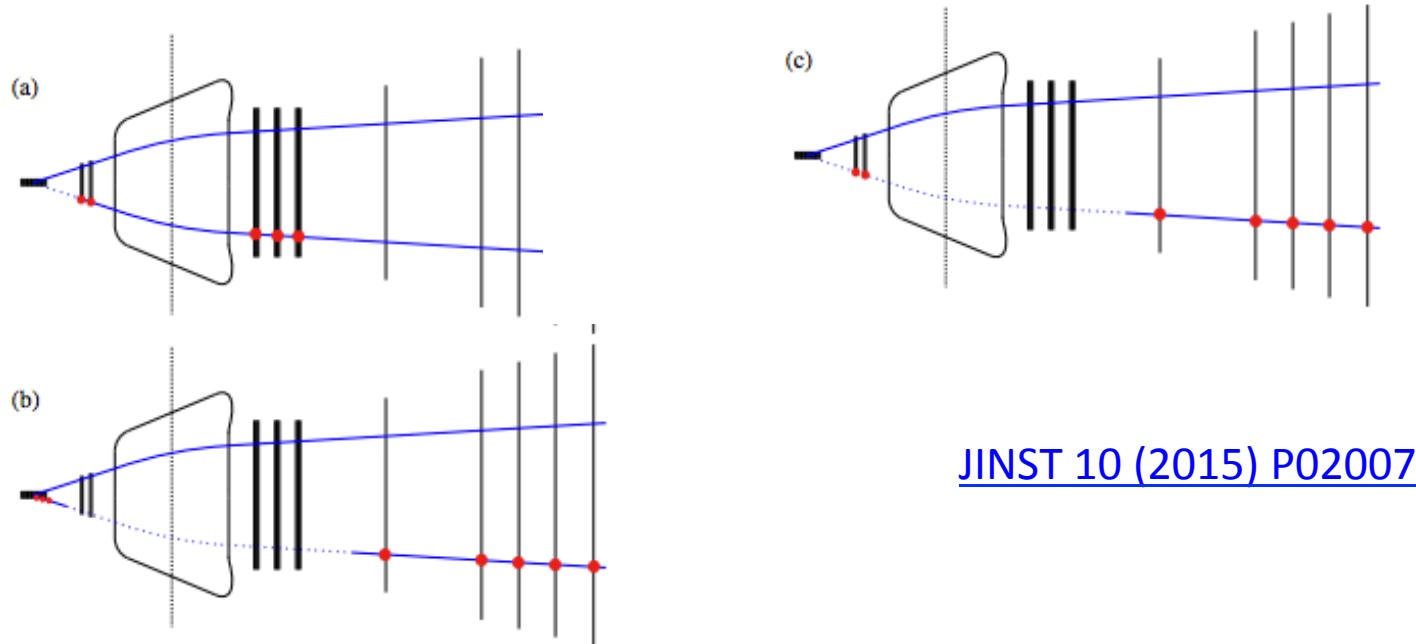

[JINST 10 \(2015\) P02007](#)

Figure 2. Illustration of the three tag-and-probe methods: (a) the VELO method, (b) the T-station method, and (c) the long method. The VELO (black rectangle), the two TT layers (short bold lines), the magnet coil, the three T stations (long bold lines), and the five muon stations (thin lines) are shown in all three subfigures. The upper solid blue line indicates the tag track, the lower line indicates the probe with red dots where hits are required and dashes where a detector is probed.

VeloTT speedup

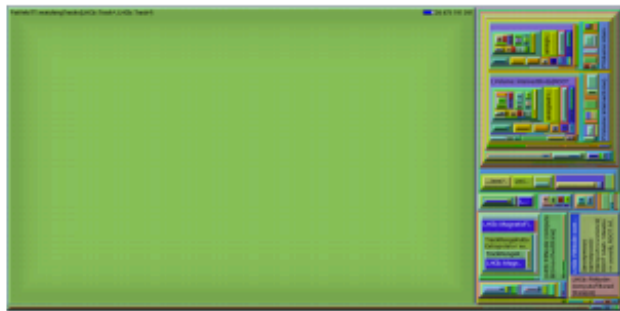

v45r1

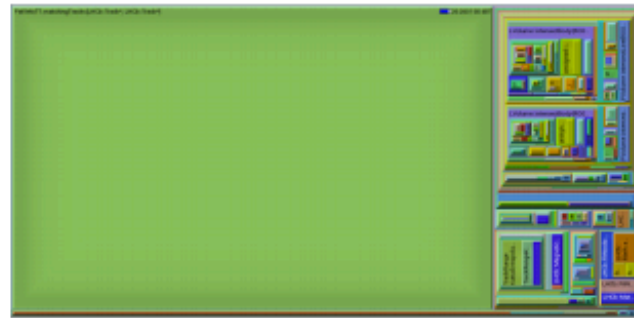

v48r1



v48r1 (2015 reco)

- transition from PatVeloTT to PatVeloTTHybrid: almost factor 40 speedup!