



The new Fibre Tracker for LHCb

Christian Joram, CERN / PH

PH Detector Seminar
23 Mai 2014

Outline

- Basics of scintillating fibres
- Tracking with scintillating fibres. Pros and cons.
- A bit of history
- Short recap of SiPM technology
- The LHCb SciFi Tracker
- LHCb SciFi R&D: Challenges, strategies, status

Basics of scintillating fibres

Basics of scintillating fibres

- Scintillating fibre = Polystyrene (PS) core + plexiglass (PMMA) cladding + O(1000 ppm) dopants

$n \sim 1.59$

$n \sim 1.49$

Typical dimensions:

- core \sim mm
- 3% of core ($\sim 10 \mu\text{m}$)

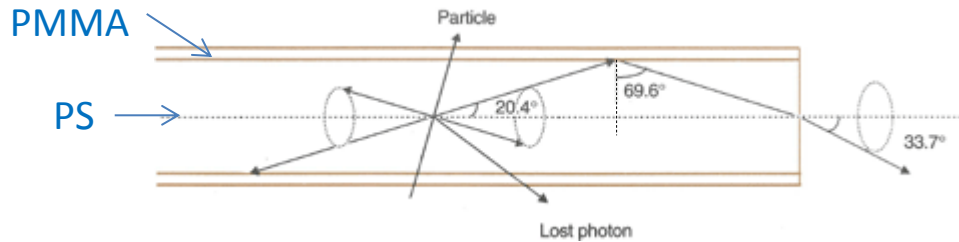

$$\theta_{crit} = \text{asin} \left(\frac{1.49}{1.59} \right) = 69.6^\circ$$

Assuming isotropic emission of scintillation light in a round fibre, the trapping fraction is

$$\epsilon_{trap} \geq \frac{1}{4\pi} \int_0^{20.4^\circ} 2\pi \sin\theta d\theta = 3.1\% \quad (\text{per side})$$

- Why " \geq " ? 3.1% corresponds to meridional modes only, i.e. rays which cross the fibre axis and which are reflected at the core/cladding boundary.

In addition there are 'cladding rays' and helical paths. They usually survive only over short distances.

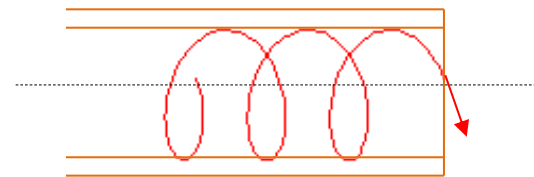
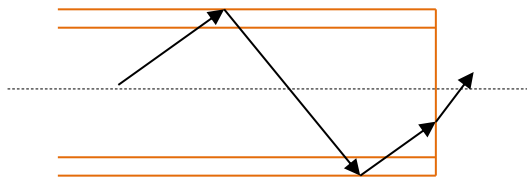

- Double cladded fibres make use of an extra layer of a fluorinated polymer with lower refractive index ($n = 1.42$) (CERN RD7 / Kuraray 1990). This is still state-of-the-art!

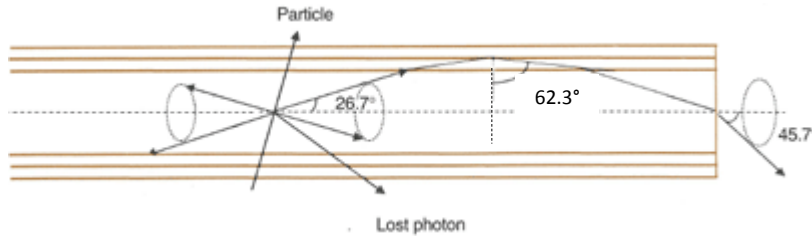

$$\epsilon_{trap} \geq \frac{1}{4\pi} \int_0^{26.7^\circ} 2\pi \sin\theta d\theta = 5.4\%$$

- Scintillating fibres exist also in other geometries and flavours

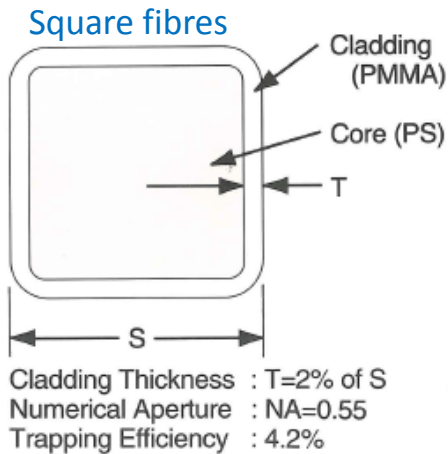

hexagonal fibres

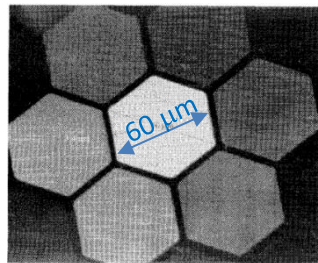

C.D. Ambrosio et al.,
NIM A 325 (1993), 161

glass capillaries with liquid scintillator

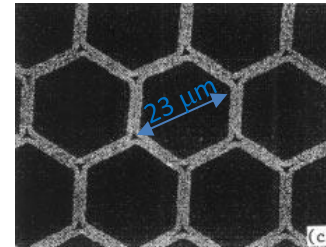

Annis P, et al. NIM A367
(1995) 377

Micro-fluidic detector study

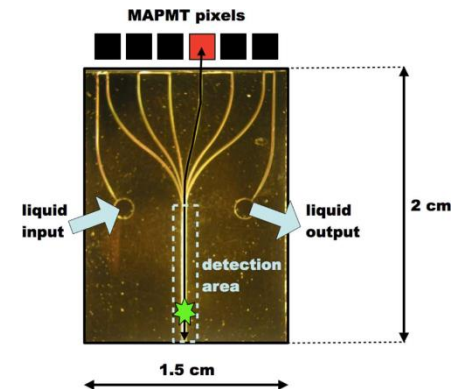

A. Mapelli et al., IEEE TNS
58, NO. 3, JUNE 2011

Scintillation in organic materials

- The organic scintillation mechanism is based on the pi-electrons (molecular orbitals) of the benzene ring (C_6H_6).

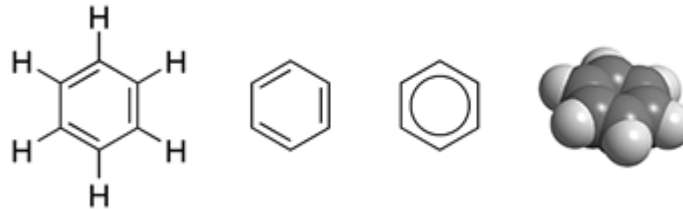

Molecular states (pi orbitals)

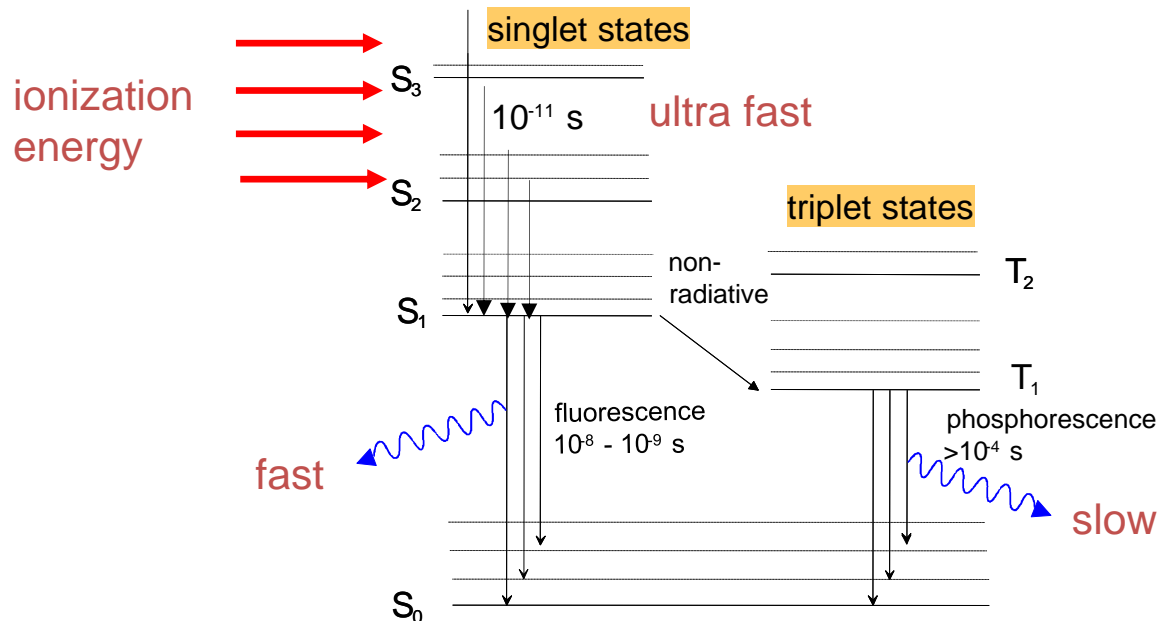

Organic scintillators exist as

- Crystals (anthracene)
- Liquids (solutions)
- Plastics (polymerized solutions)

Organic scintillators are fast. Scintillation light decay time \sim few ns.

In HEP, we use mainly

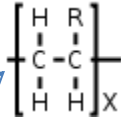

Polyvinyltoluene (PVT) ==> plastic scintillator tiles

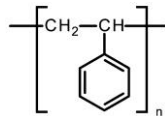

Polystyrene (PS) ==> scintillating fibres

In pure form, both PVT and PS, have a very low scintillation yield.
One adds therefore dopants in ‰ - % concentrations.

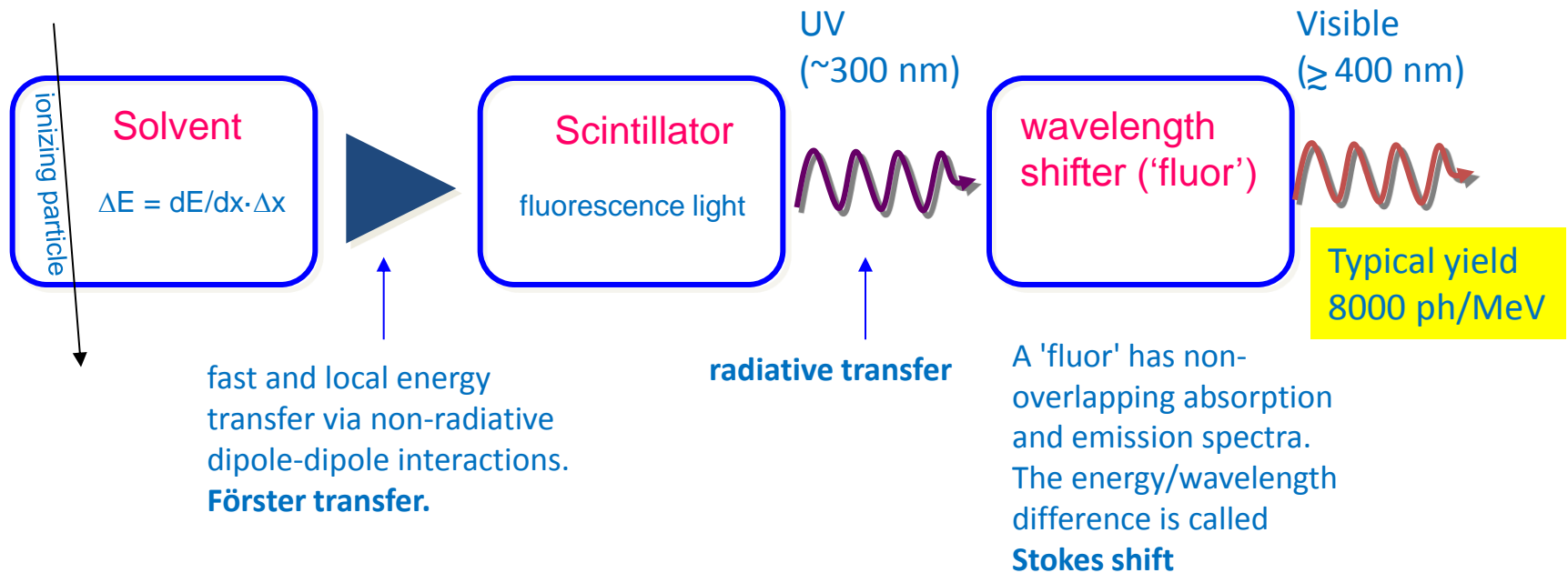

(Producers normally don't disclose the details about the additives and their concentrations.)

Emission spectrum of Kuraray SCSF-78 fibre

(baseline for LHCb Tracker TDR)

as function of distance from excitation point

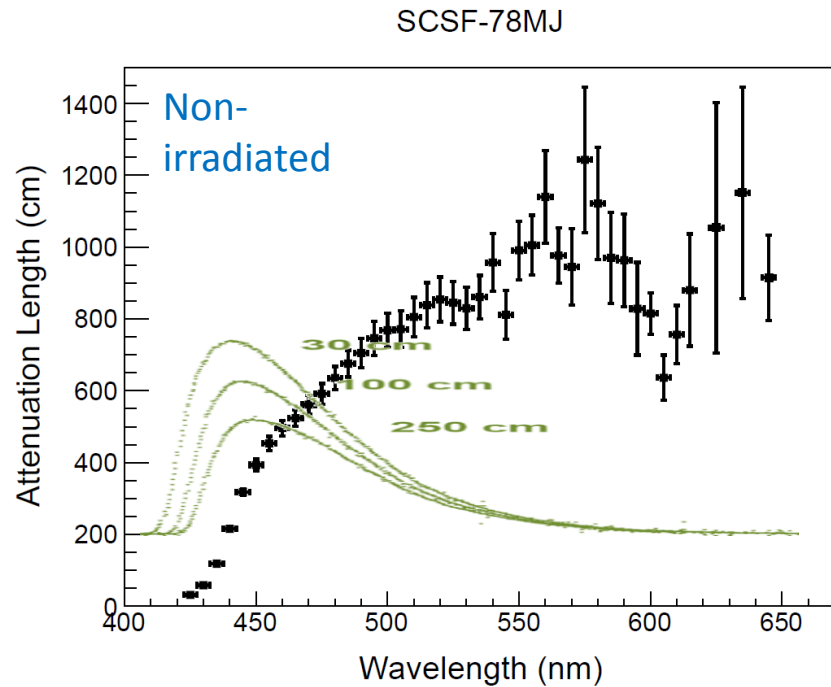
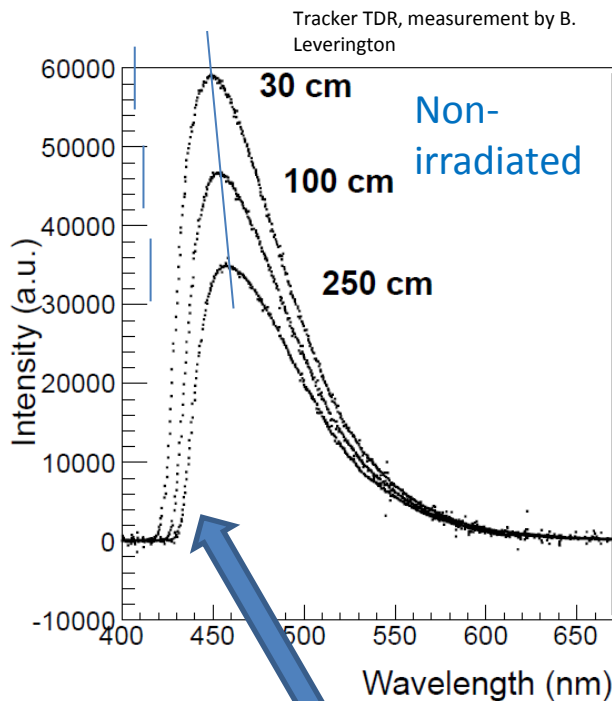
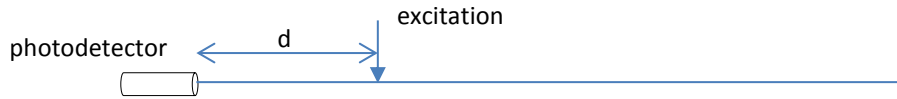

- Light is attenuated during propagation
- Blue light is stronger absorbed than green and red

$$I = I_0 \cdot e^{-\frac{d}{\Lambda}}$$

$\Lambda(\lambda)$ attenuation length

Attenuation in a 3.5 m long SCSF-78 fibre (∅ 0.25 mm) in air, averaged over emission spectrum

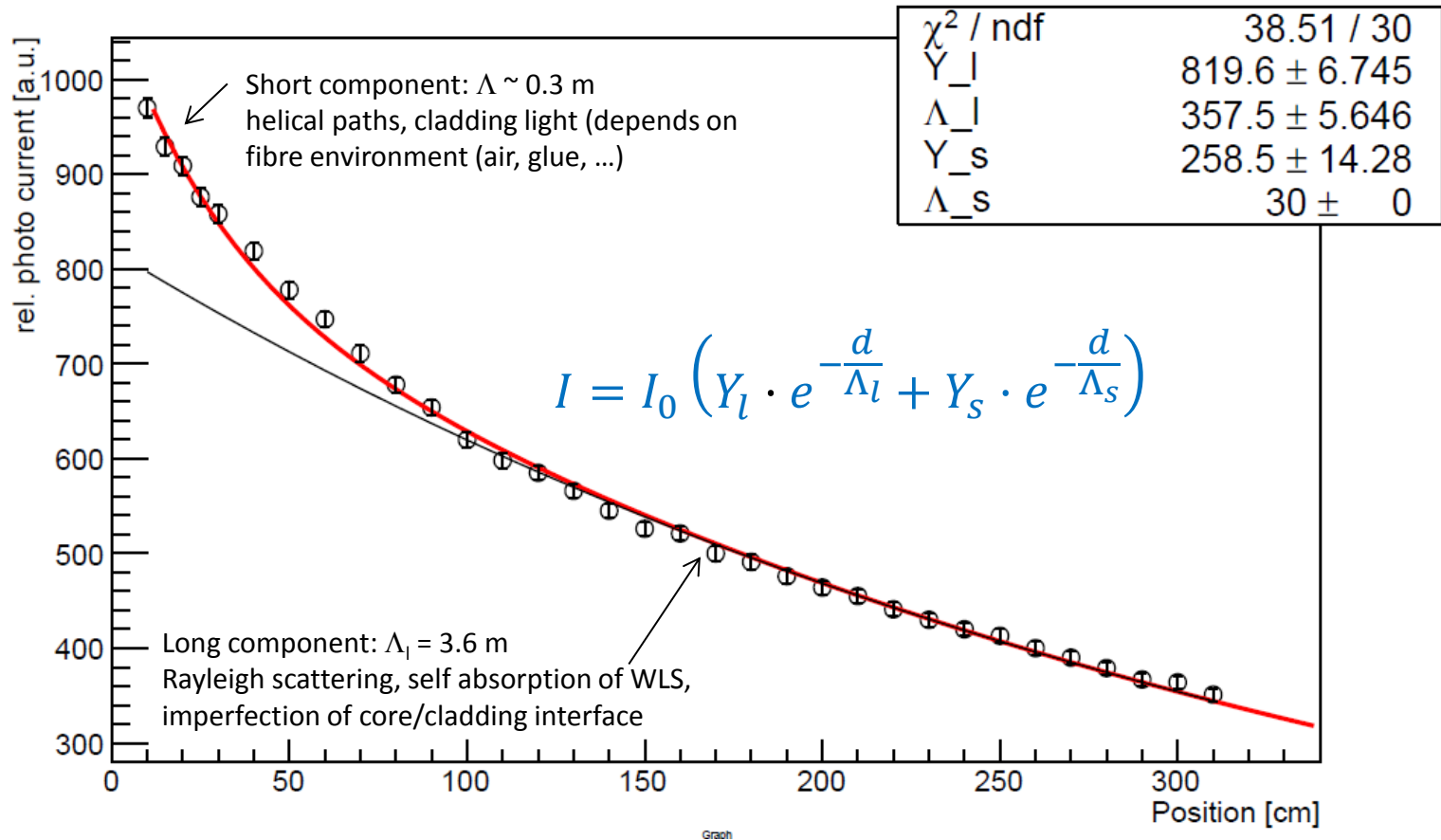

Radiation damage of scintillating plastic fibres

C. Zorn, A pedestrian's guide to radiation damage in plastic scintillators, Nuclear Physics B - Proceedings Supplements 32 (1993), no. 0 377

- Mainly studied in the 1990ies, but often poor dosimetry and not very well documented.
- Literature gives partly contradictory results / interpretations (impact of radiation type, dose rate, environment).
- Agreement that the main effect of ionizing radiation is a **degradation of the transparency of the core material** (PS), while scintillation yield and spectrum are unaffected.
- Radiation leads to the formation of radicals in the fibre which act as colour centres. Those can in principle react with oxygen and anneal. **Environmental parameters** may therefore play a role.
- Viability of a fibre depends crucially on its length and the dose distribution along the fibre in the specific application.

→ Irradiation tests should therefore be performed under conditions which resemble as much as possible the ones met in the experiment.

Example: LHCb irradiation test (2012)

- 3 m long SCSF-78 fibres (\varnothing 0.25 mm), embedded in glue (EPOTEK H301-2)
- irradiated at CERN PS with 24 GeV protons (+ background of $5 \cdot 10^{12}$ n/cm²)

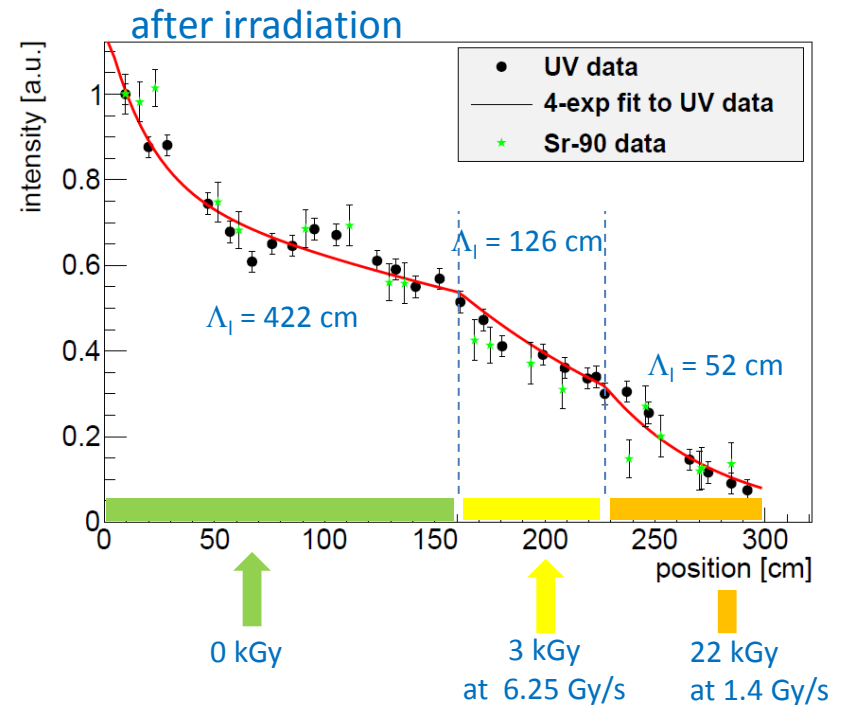
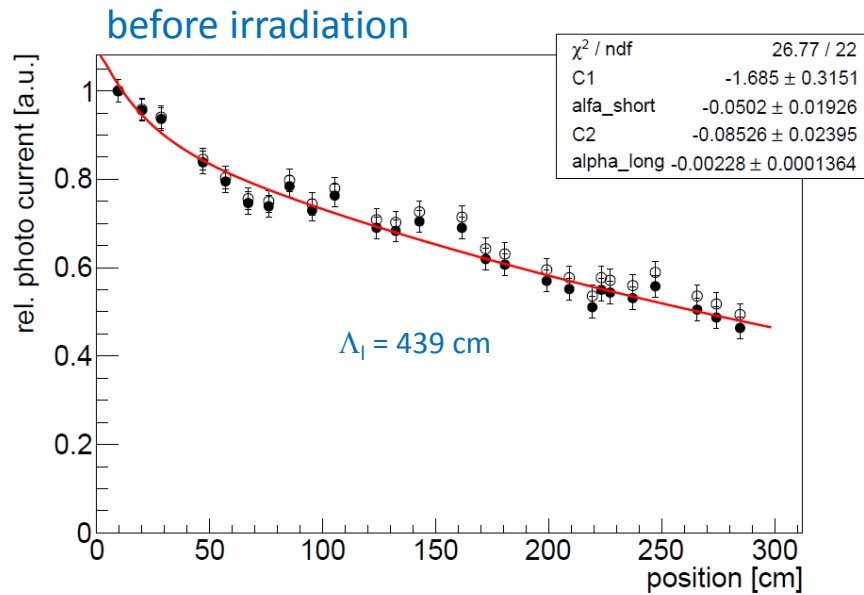

Back-of-the-envelope estimate of photoelectric yield in a 0.25 mm double cladded fibre, 1 m from photodetector. Non-irradiated.

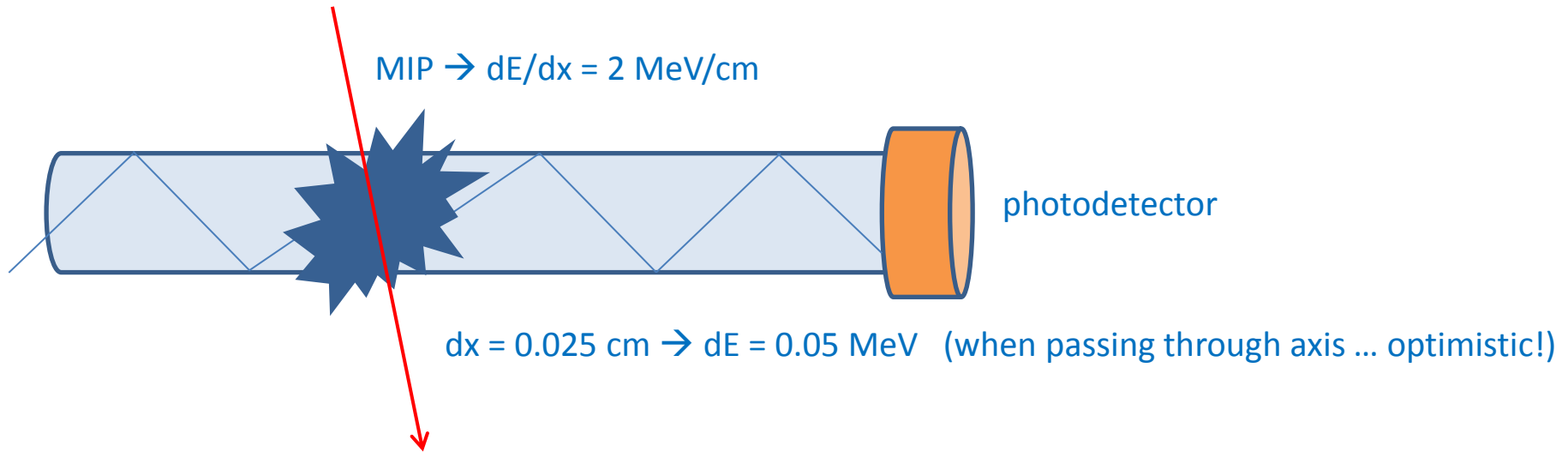

- Scintillation yield: $dY_\gamma/dE = 8000 \text{ ph / MeV}$ $\rightarrow Y_\gamma = 400$
- Trapping inside fibre (1 hemisphere): 5.4% $\rightarrow Y_\gamma \sim 20$
- Attenuation losses over 1 m: 22% $\rightarrow Y_\gamma \sim 16$
- Efficiency of photodetector (typ. PMT): 25% $\rightarrow Y_{\text{p.e.}} \sim 4$

- \rightarrow Need more traversed fibre thickness
- \rightarrow Need higher photodetector efficiency
- \rightarrow Need to recover light in the second hemisphere

A tracker serves to detect particles with

- high efficiency → enough light, low threshold
- good spatial resolution → fibre diameter, readout geometry, mechanical precision

In addition...

- it should give no/few false hits (ghosts) → low noise
- It should have low mass
- It should survive the radiation damage
- It should be affordable
- LHCb specific: it should allow for fast readout rate (40 MHz)

Tracking with scintillating fibres -

Pros and Cons

- +** flexible in shape (planar, cylindrical) and size
- +** light weight (X_0 (PS) = 42.4 cm, 1 mm fibre = 0.25% X_0)
- +** fibres generate and transport optical signal → the active region can consist of active material only (almost 😊)
- +** the material distribution can be very uniform
- +** fast signal (ns decay times)
- +/-** medium resolution, $O(50 \mu\text{m})$
- quite small signals (few p.e.)
- limited radiation hardness
- cumbersome production (no company delivers high precision fibre layers).

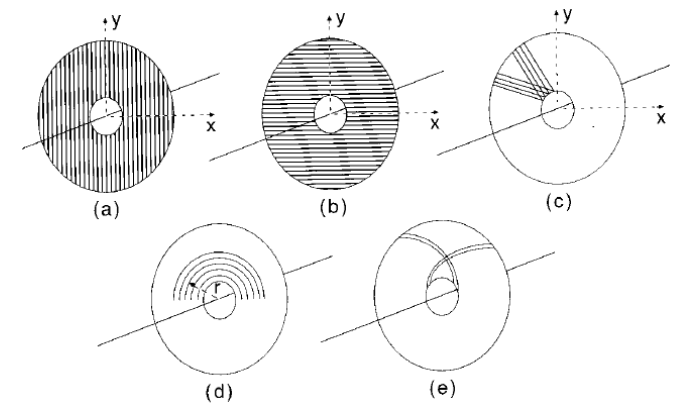
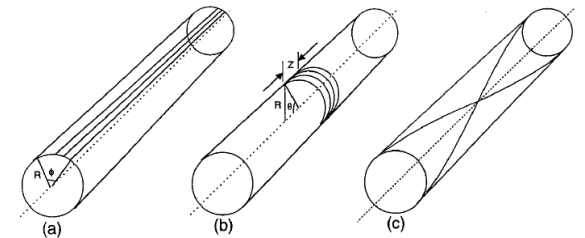

R.C. Ruchti, *Annu. Rev. Nucl. Part. Sci.* 1996. 46:281–319

A bit of history

A bit of history

Jean-Daniel Colladon, a 38-year-old Swiss professor at University of Geneva, demonstrated (by accident) light guiding or total internal reflection for the first time in 1841.

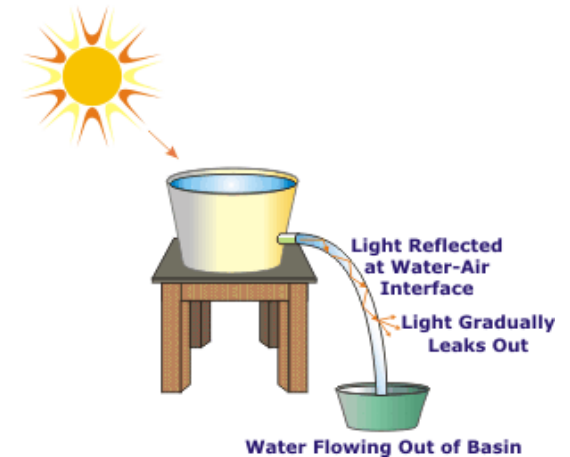

Filament Scintillation Counter*

Rev. Sci. Instrum. 28, 1098 (1957);

GEORGE T. REYNOLDS AND P. E. CONDON

*Palmer Physical Laboratory, Princeton University,
Princeton, New Jersey*

The above result indicates that a minimum ionizing particle passing through a filament of 1-mm diameter (index of refraction 1.58) would, on the average, result in 110 photons appearing at the end of the filament,

..... . Viewed with image intensifier tubes currently being developed,^{3,4} these filaments would provide a solid scintillation chamber capable of fast timing and good space resolution

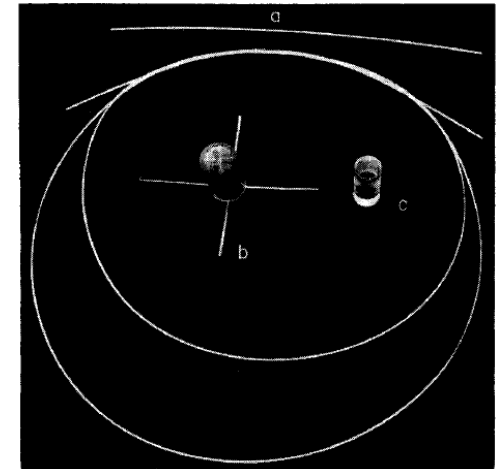

First (?) non-cladded scintillating plastic fibre.

Upgrade of the **UA2** experiment (1985-87).

J. Alitti et al. , NIM A 273 (1988) 135

The first major collider application of scintillating fibre tracking technology.

- Outer tracking and pre-shower measurement for electron identification.
- **60,000** single-clad, blue-emitting scintillating fibres of **1 mm in diameter** and 2.1 m long
- developed and produced (!) at Saclay. $\Lambda > 1.5$ m.
- Light propagates to 32 collector plates which are readout by **32 image-intensified CCDs** (32000 pixels each).

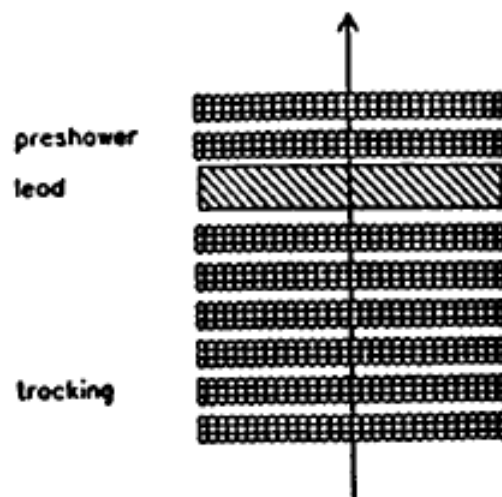
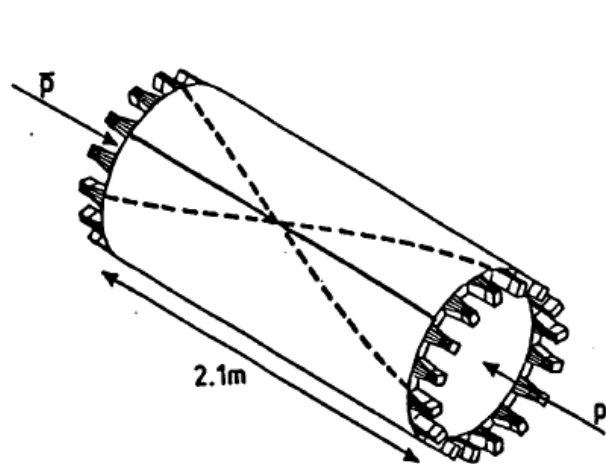

collector plate

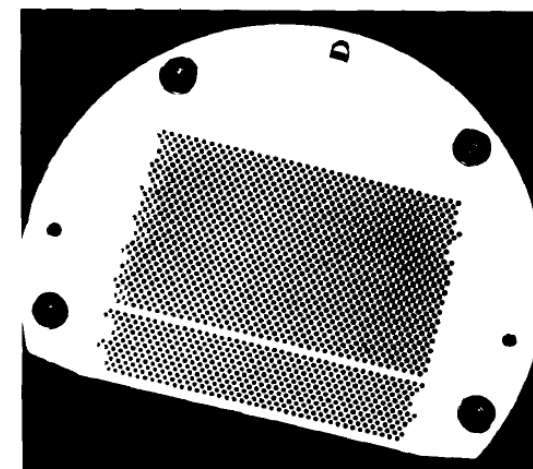

UA2 readout system

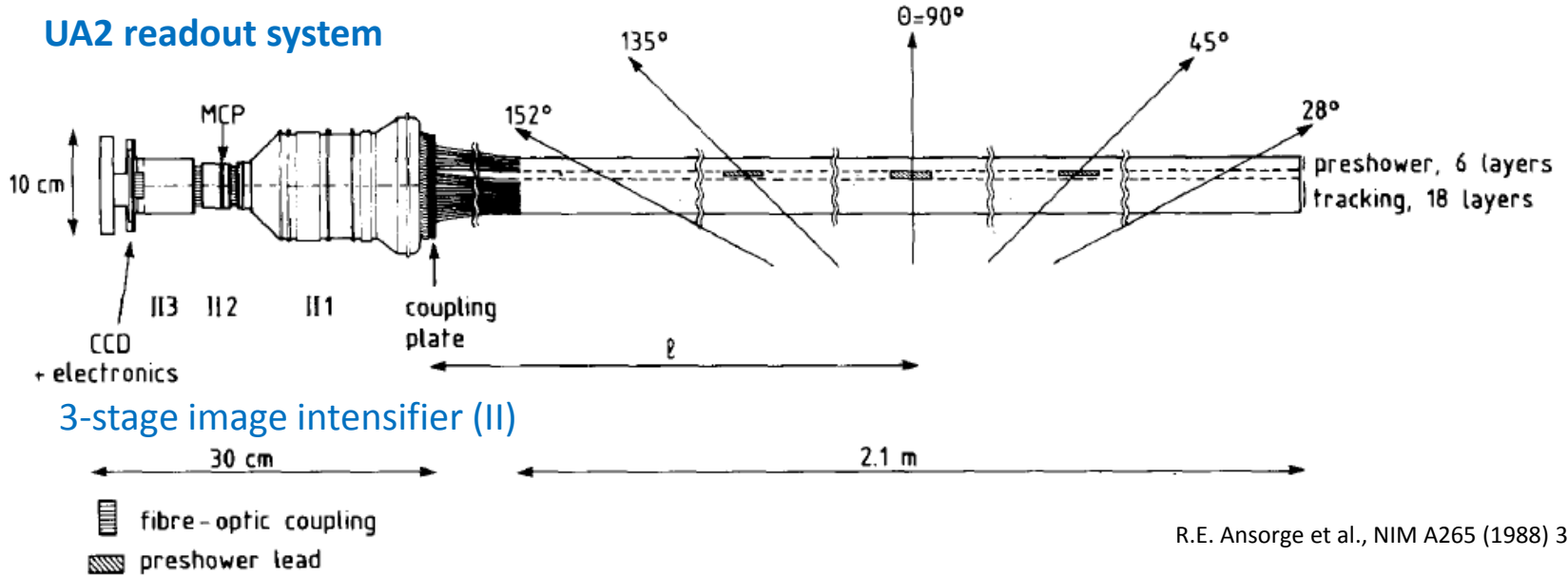

R.E. Ansorge et al., NIM A265 (1988) 33-49

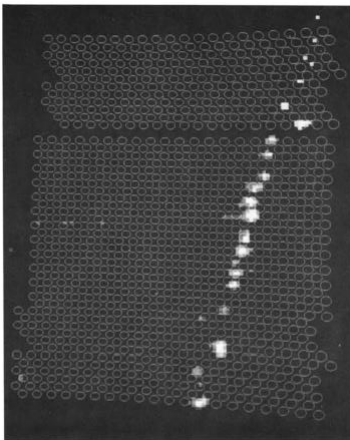

CCD image (circles show calculated fibre positions)

Performance

- 2.8 p.e. per fibre (1mm)
- Single fibre efficiency: >91%
- $\sigma_{\text{hit}} = 0.35 \text{ mm}$, $\sigma_{\text{track}} = 0.2 \text{ mm}$
- Readout time $\sim 10 \text{ ms}$

CHORUS

Annis P, et al.
NIM A367
(1995) 367

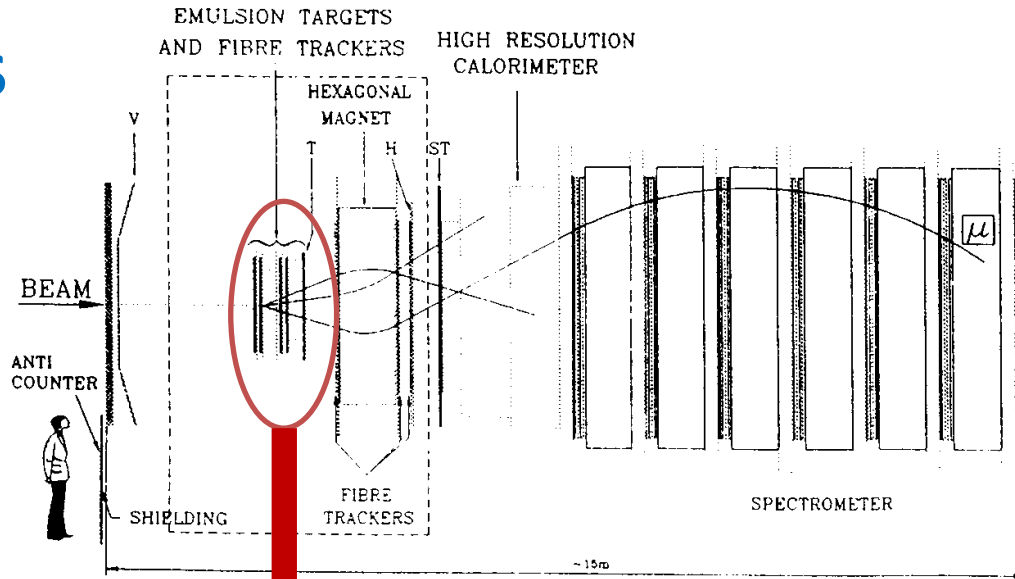

- 10^6 scintillating fibres of $\varnothing 500 \mu\text{m}$
- 58 image-intensifier chains + CCD,
- similar to UA2.

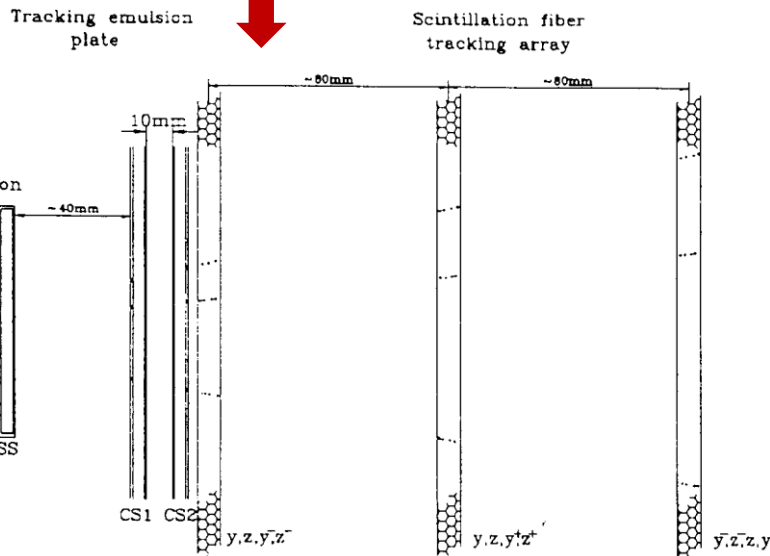

The scintillating fibre-tracking layers provide pre-localisation of the regions to be scanned in the emulsion.

They also tested a micro-vertex tracker based on the liquid-in-capillary concept (see photo on slide 5).

DØ

The upgraded DØ detector comprises a 80,000-channel central fiber tracker (CFT).

V.M. Abazov et al, A 565 (2006) 463–537

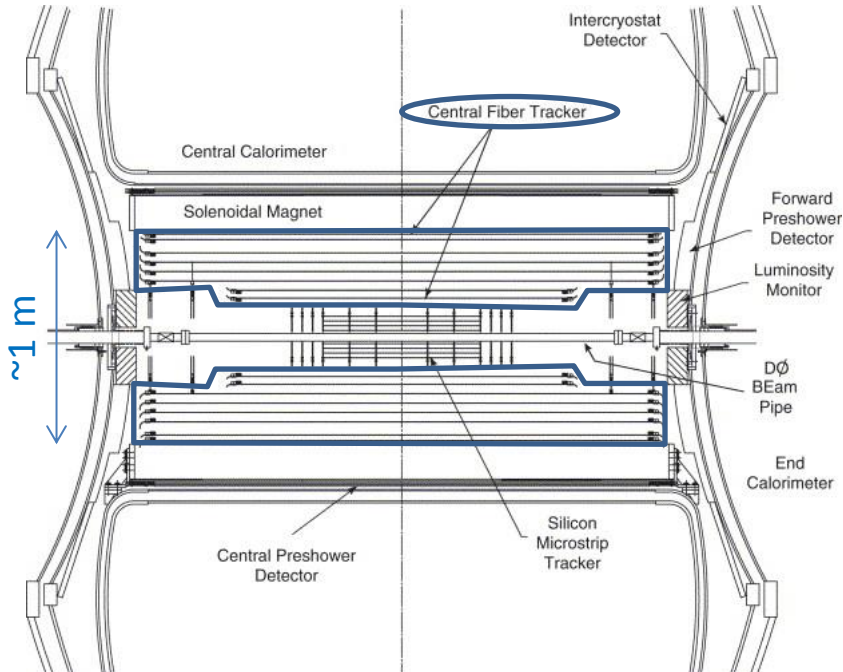

Ø 835 µm fibres are arranged in 'Doublet' structure

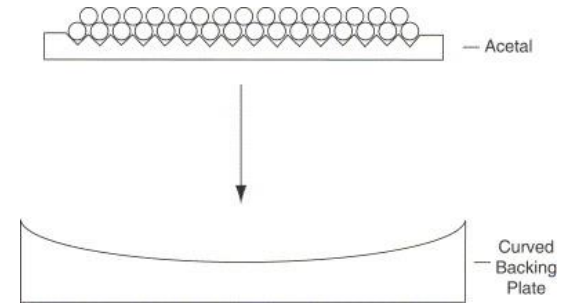

- 8 concentric layers (axial + stereo)
- $L_{\text{fibre}} \sim 2 \text{ m} + O(10)\text{m}$ clear waveguide
- Total = 200 km of scintillating and 800 km of clear fibres

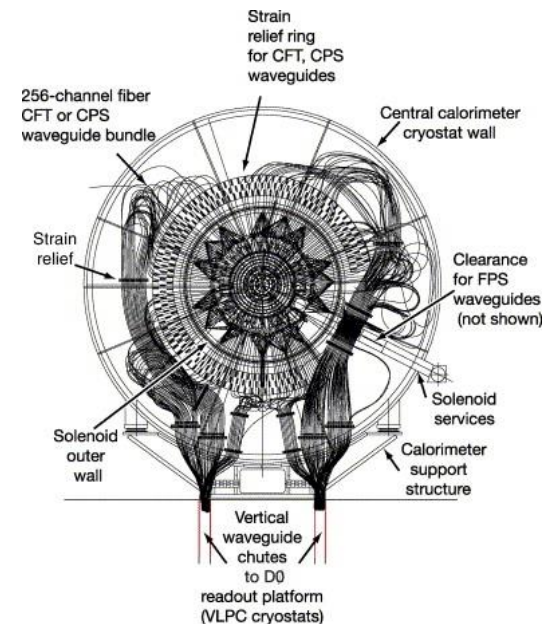

Very innovative readout in D0: Visible Light Photon Counters (VLPC)

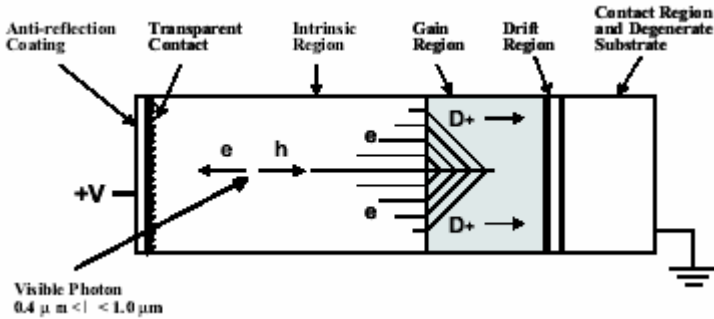

Si:As avalanche photodiode
 Very high QE: ~ 75%
 High gain: ~40.000
 ! Needs to be operated at 9 k!

LED calibration spectrum

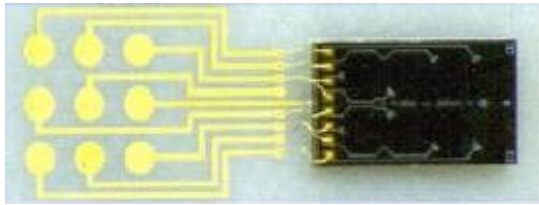
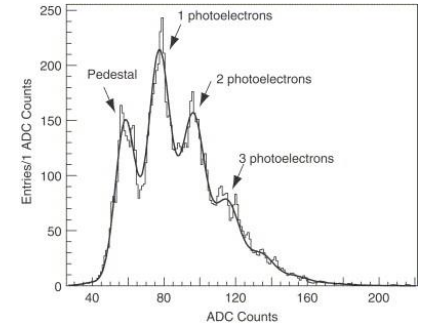

D0 used chips with 8 VLPCs (Ø 1mm)
 128 chips fit in a cassette

Performance (partly from test stand)

B. Baumbaugh et al. IEEE TNS 43, NO. 3, JUNE 1996

- Yield: ~10 pe / fibre
- Hit efficiency: 99.5%
- Doublet hit resolution: 100 μm
- Fast readout: CFT contributes to the L1 trigger (every 132 ns)

Same technology is also used in the MICE experiment <http://mice.iit.edu/>

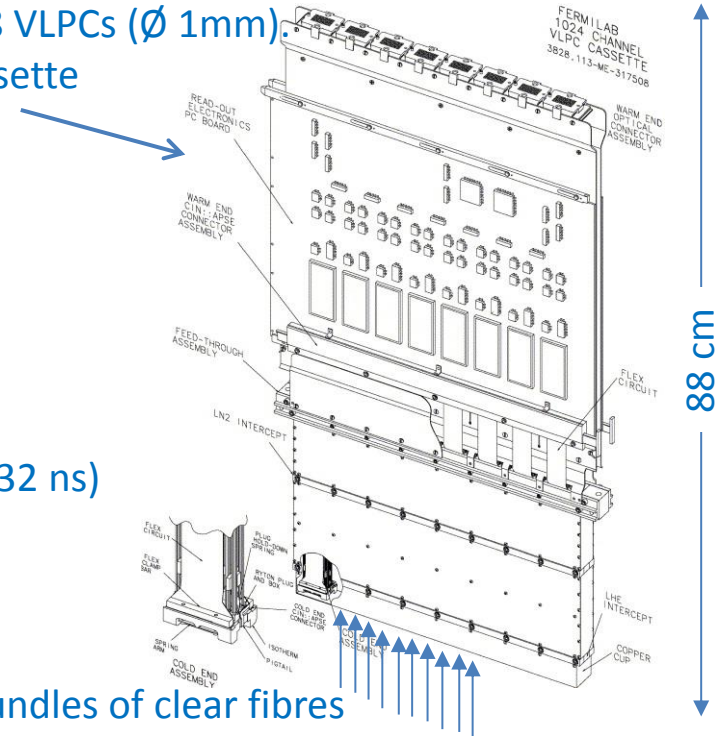

Bundles of clear fibres

Forward detector in Roman Pots for luminosity and $\sigma_{\text{tot}}(\text{pp})$ measurement

4 RP stations are located at ± 240 m from ATLAS in LHC tunnel

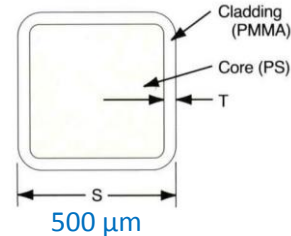
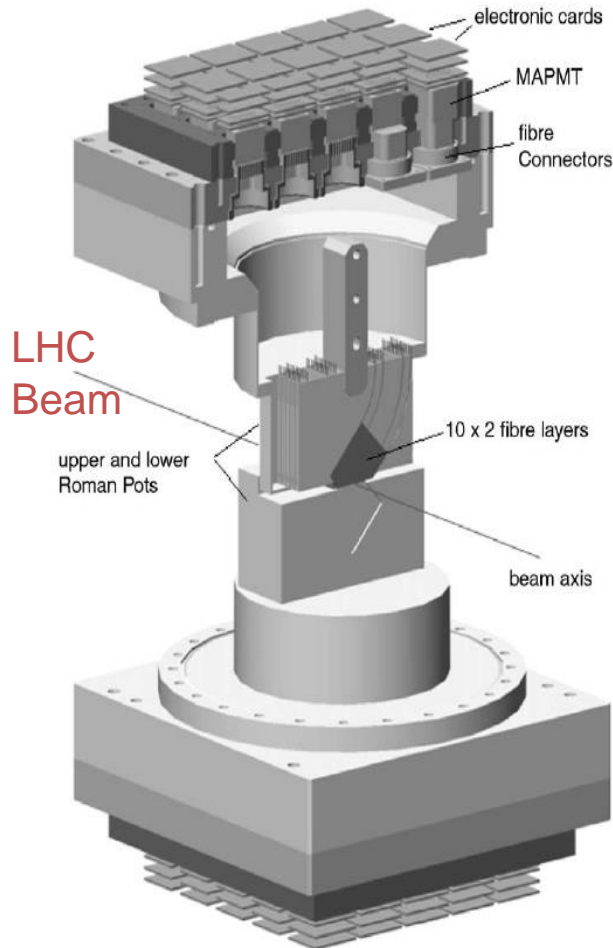

- Total $\sim 11,000$ fibres, $500 \mu\text{m}$ squared, ~ 35 cm long, aluminized for reduced cross-talk.
- UV geometry with 2×10 staggered layers. Active area is only about $3 \times 3 \text{ cm}^2$.
- Readout (at 40 MHz) by 184 Multi-anode (64 ch.) PMTs.

Performance:

- Yield: $\sim 4 \text{ pe / fibre}$
- Track resolution: $\sim 25 \mu\text{m}$

A short recap of SiPM technology

A short recap of SiPM technology

PIN photodiode

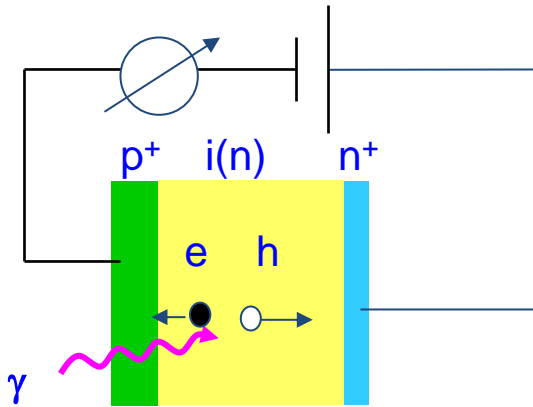

- $U_{\text{bias}} = \text{small (or even 0)}$
- No charge gain ($G=1$)
- High QE ($\sim 80\%$)

Used in calorimetry (1980-2000),
e.g. L3

Avalanche Photodiode (APD)

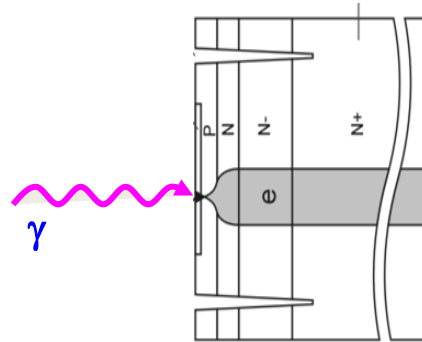

- $U_{\text{bias}} = \text{few } 100 \text{ V}$
- Avalanche, self terminating
- Charge gain $G \sim \text{few } 100$
- Excess noise, increasing with G
- $\Delta G = 3.1\%/V$ and $-2.4\%/K$
- High QE ($\sim 80\%$)

Used e.g. in CMS ECAL

SiPM

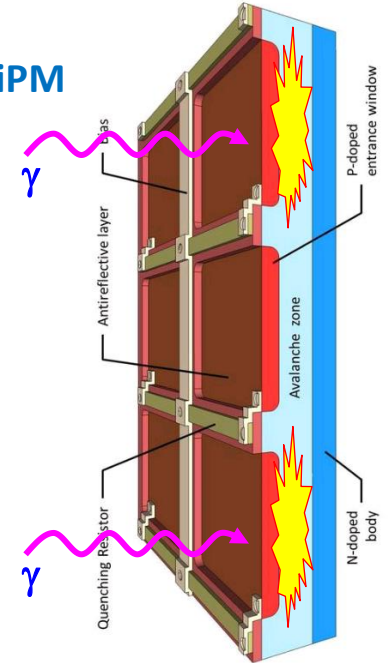

Multi-pixel array of APD

- operated in Geiger mode, i.e. above break down
- with quenching
- $G \sim 10^6 - 10^7$

All these devices are immune to magnetic fields !

100 – several 10000 pix / mm²

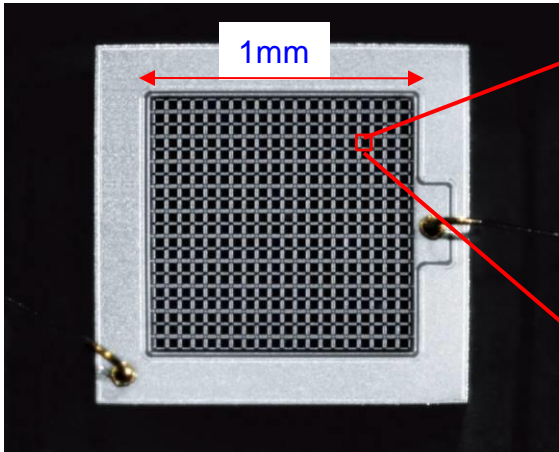

Sizes up to 6x6 mm² now standard.

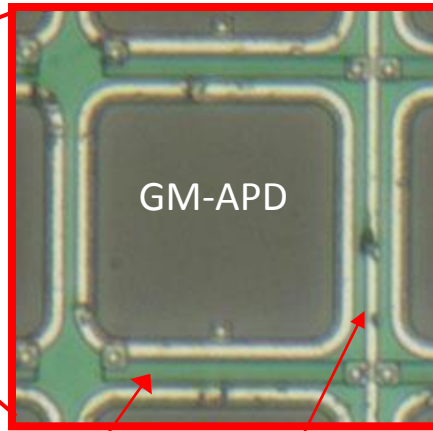

Only part of surface is photosensitive!

Photon detection efficiency

$$PDE = QE \cdot \epsilon_{\text{geom}} \cdot \epsilon_{\text{avalanche}}$$

↓

=f(OV)

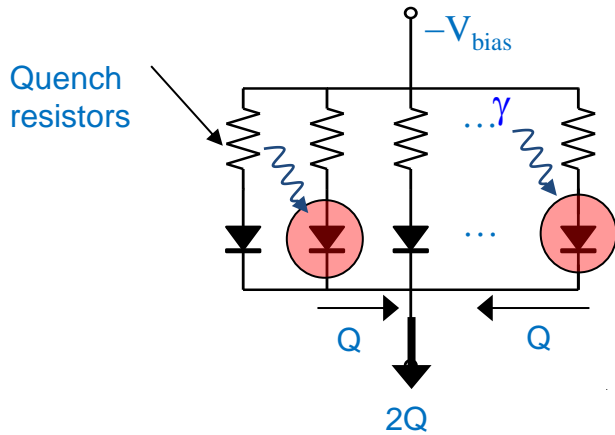

quench resistor bias bus

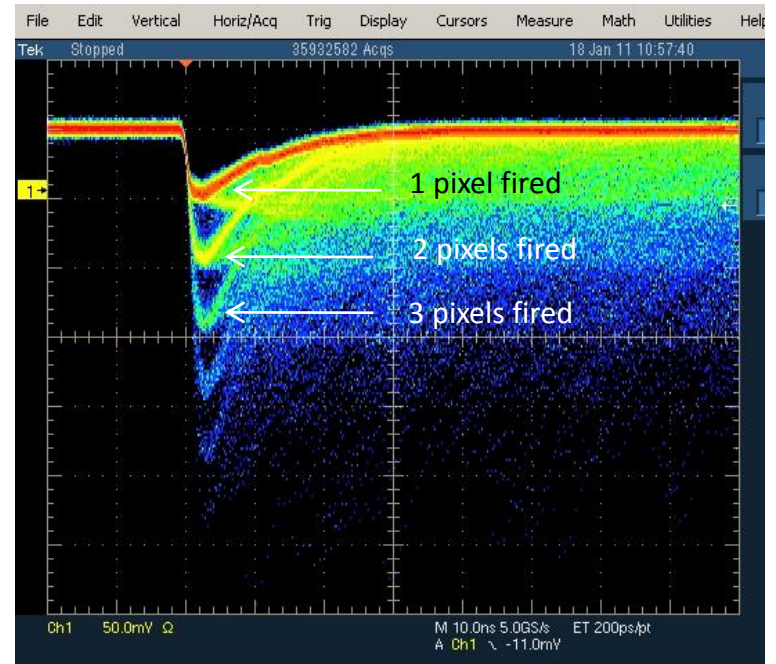

- 1 GM-APD is a binary device.
- The operation of many GM-APDs in parallel leads to a quasi-analog detector with photon counting properties.

The 'dark' side of the SiPM detector

- **Thermal/tunneling** : thermal/ tunneling carrier generation in the bulk or in the surface depleted region around the junction
- **After-pulses** : carriers trapped during the avalanche discharging and then released triggering a new avalanche during a period of several 100 ns after the breakdown
- **Optical cross-talk**: 10^5 carriers in an avalanche plasma emit on average 3 photons with an energy higher than 1.14 eV (A. Lacaita et al. IEEE TED 1993). These photons can trigger an avalanche in an adjacent μ cell.

→ Limit gain, increase threshold

→ add trenches btw μ cells

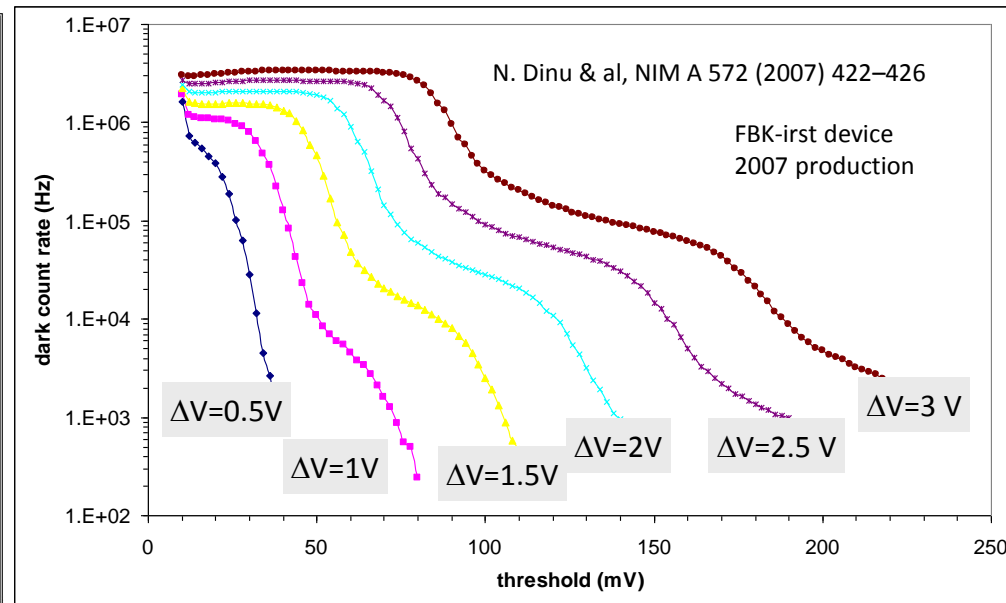
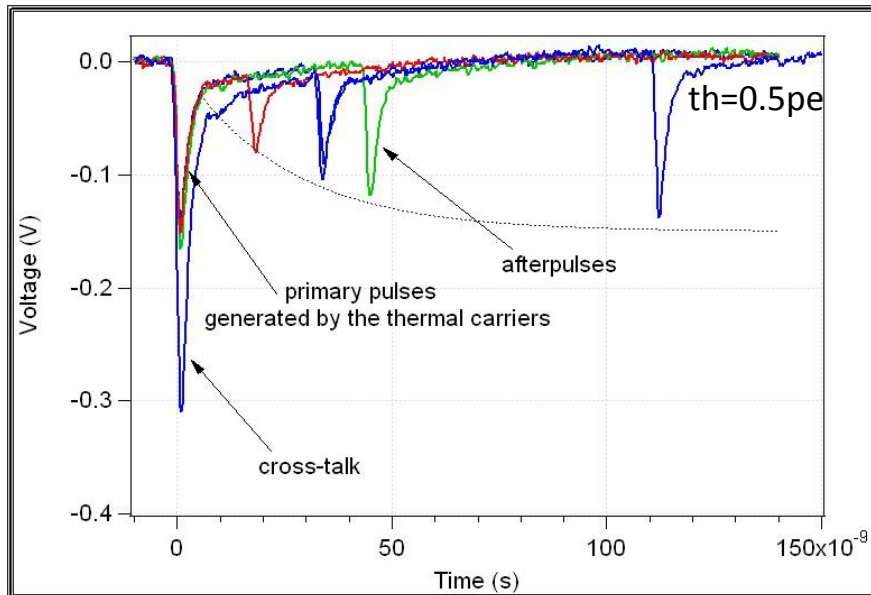
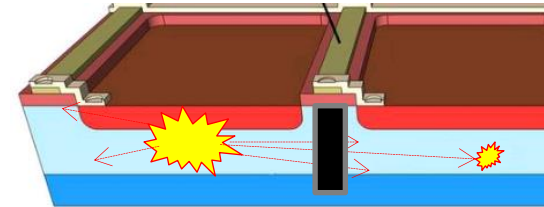

In addition... as for every Si detector, radiation damage is an issue. Linear increase of dark noise rate (DCR) with n-fluence. No other serious effects.

$$DCR \sim \Phi_{n,1\text{MeV eq.}} \quad I_{\text{dark}} = e \cdot G \cdot DCR$$

I.Nakamura, JPS meeting, Sep. 2008

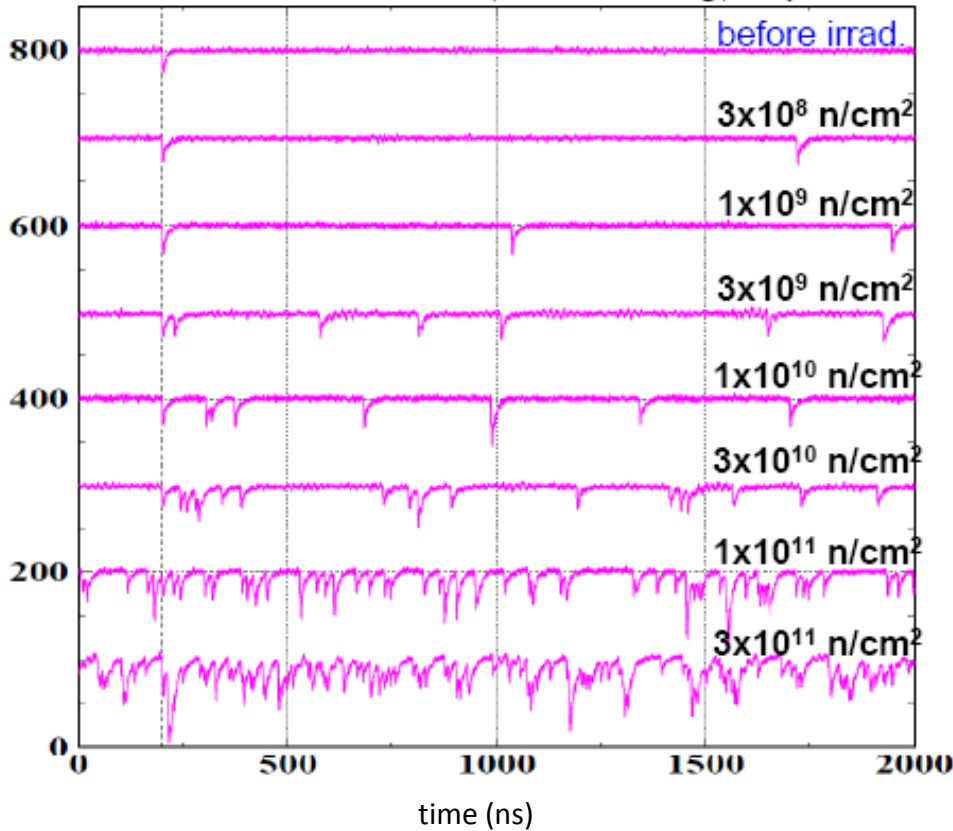

Fortunately cooling helps!

MPPC S10362-11-050U-3

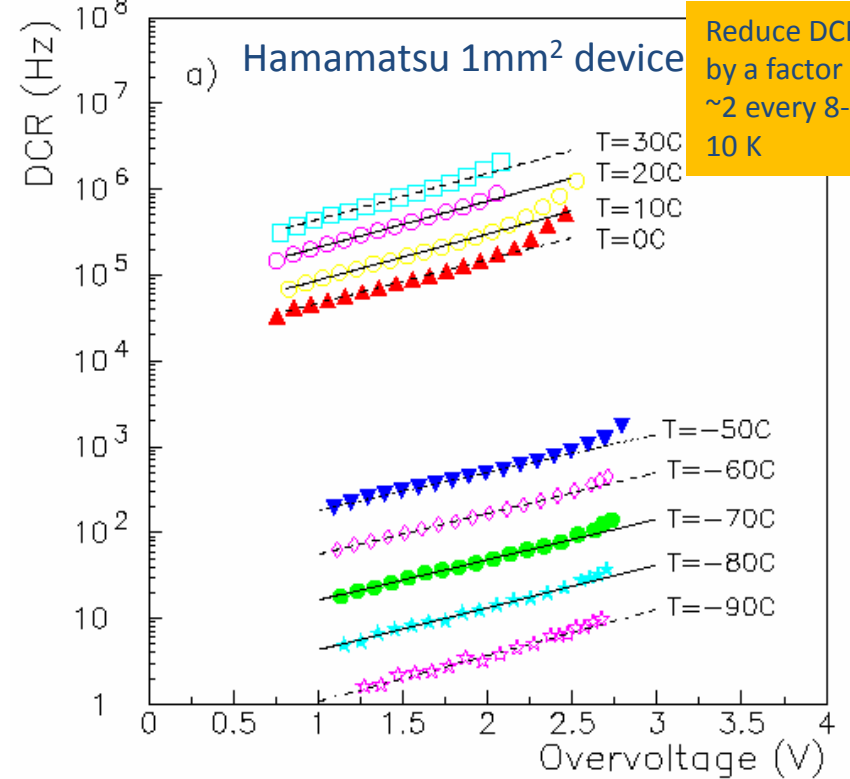

N. Dinu et al., NSS Conf Record (NSS/MIC), 2010 IEEE, vol., no., pp.215-219,

The LHCb SciFi Tracker

Major tracking upgrade of LHCb (for after LS2, ≥ 2020 , 50fb^{-1})

Aim for the same performance at high luminosity ($2 \cdot 10^{33} \text{ cm}^{-2}\text{s}^{-1}$, 25 ns, $v = 7.6$) as under current conditions ($< 4 \cdot 10^{32}$, 50 ns, $\mu = 1.7$).

- New VELO, Si pixel based
- New Upstream tracker (UT), Si- μ strip
- SciFi Tracker, scintillating fibres

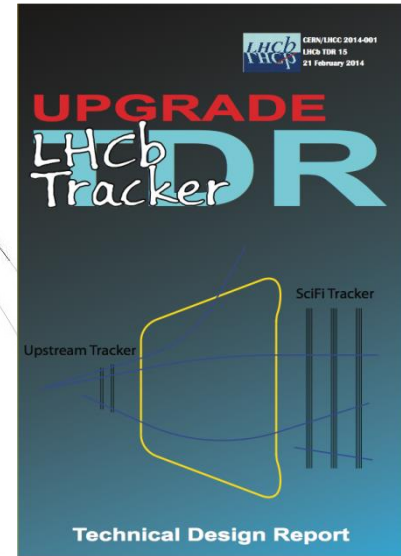
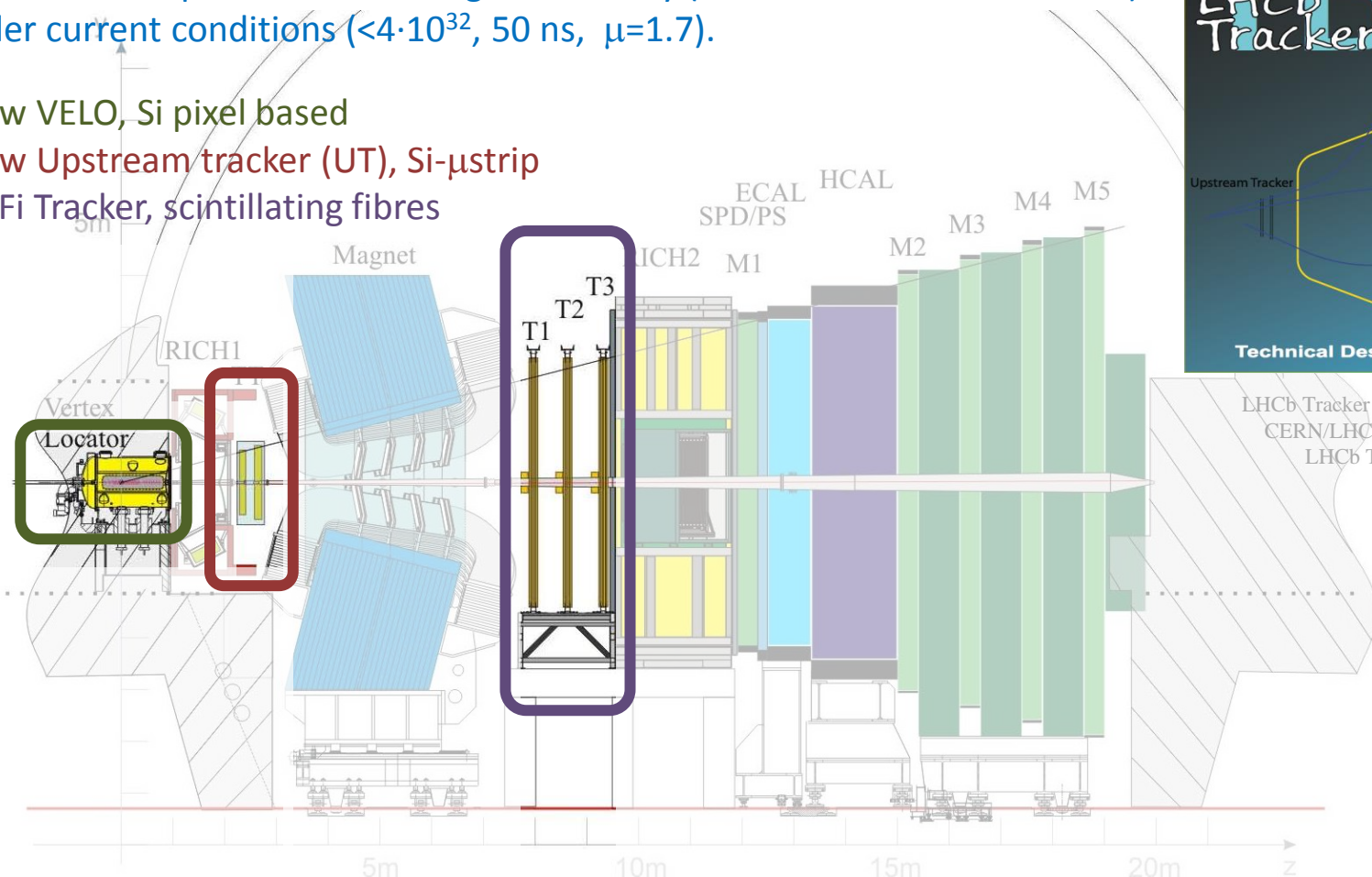

LHCb Tracker Upgrade TDR
CERN/LHCC 2014-001
LHCb TDR 15

LHCb FLUKA simulation

1MeV neutron Eq. fluence/cm² for 50fb⁻¹ (100mb)

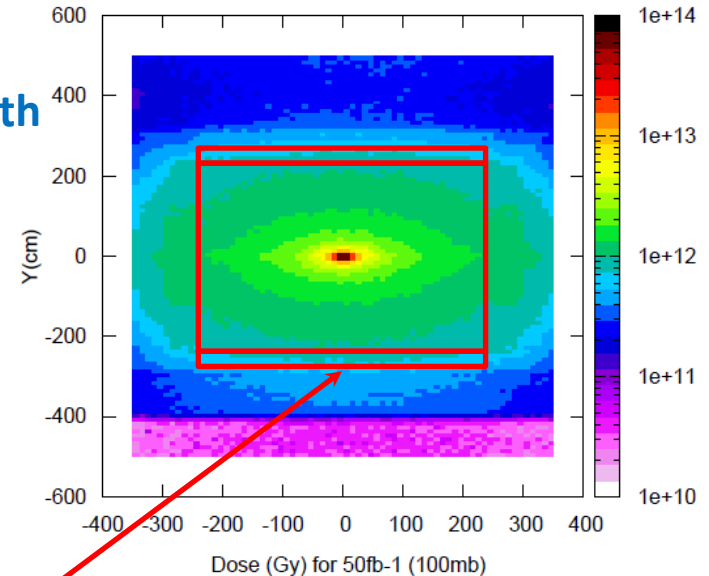

Dose (Gy) for 50fb⁻¹ (100mb)

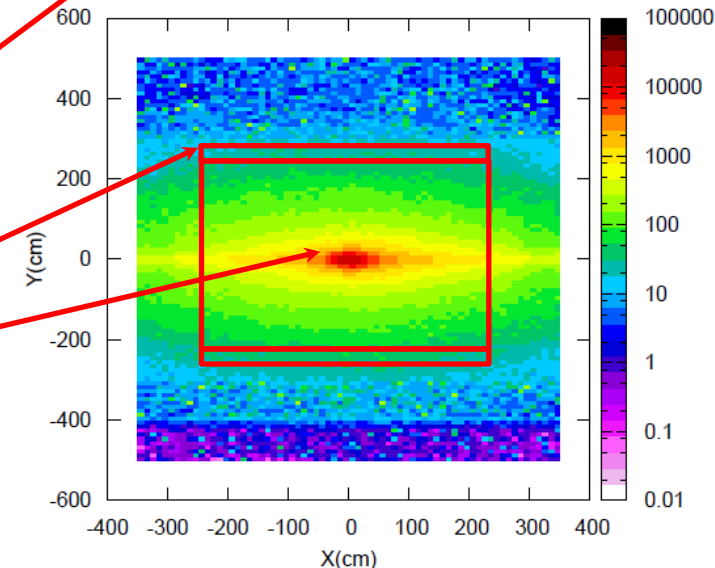

Main requirements

Detector intrinsic performance: measure x, x' (y, y') with

- high hit efficiency (~99%)
- low noise cluster rate (<10% of signal at any location)
- $\sigma_x < 100\mu\text{m}$ (bending plane)
- $X/X_0 \leq 1\%$ per detection layer

Constraints

- 40MHz readout
- geometrical coverage: 6(x) x 5(y) m²
- fit in between magnet and RICH2
- radiation environment:
 - $\leq 10^{12}$ 1MeV $n_{\text{eq}} / \text{cm}^2$ at the location of the photo-detectors
 - $\leq 80\text{Gy}$ at the location of the photo-detectors
 - $\leq 35\text{kGy}$ peak dose for the scintillating fibres

→ low temperature operation of photodetectors

General layout of the detector geometry: 3 stations with 4 planes each X-U-V-X

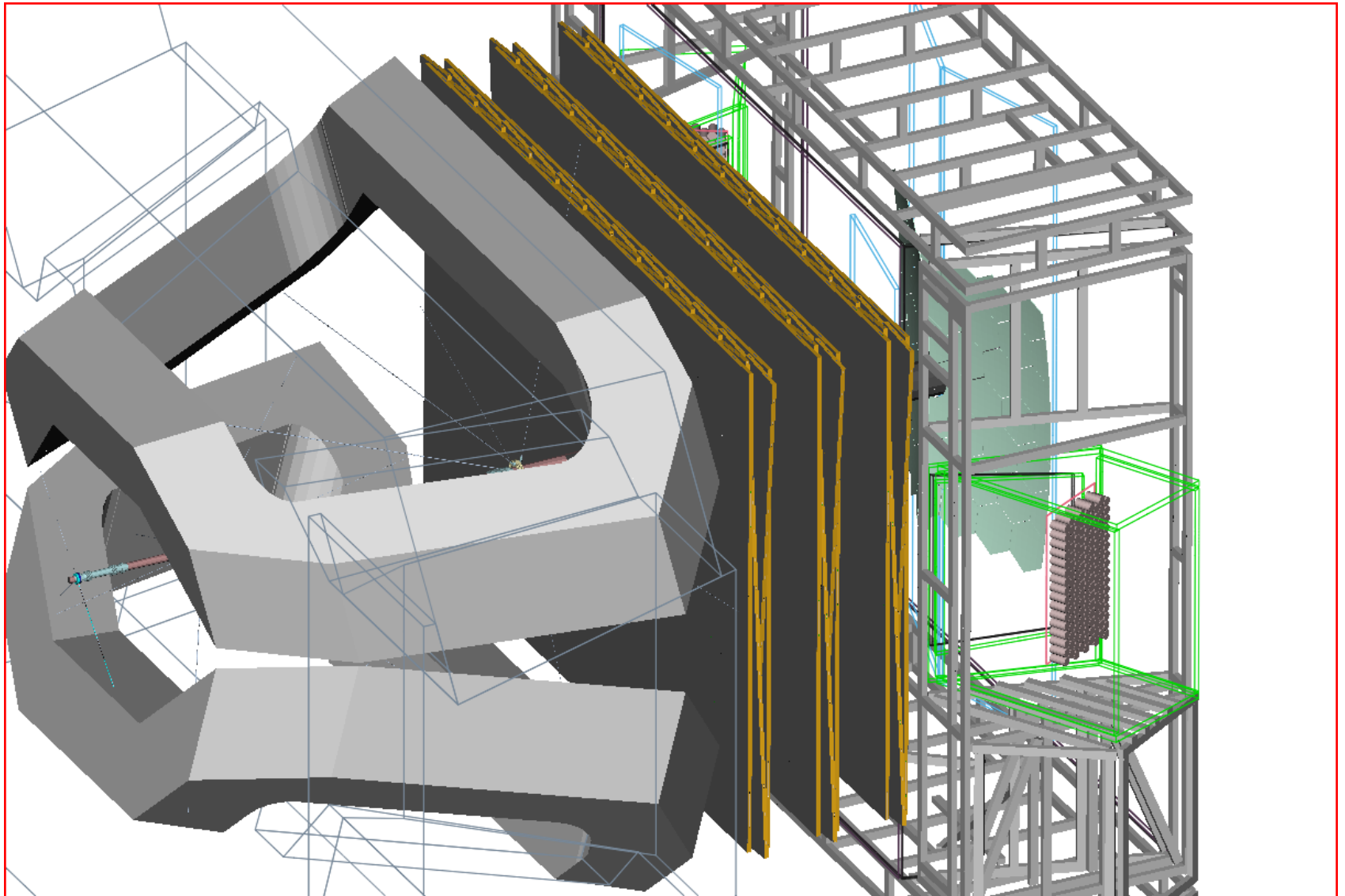

- 10 or 12 (almost) identical modules per detection plane
- Fibre ribbons (mats) run in vertical direction.
- fibres interrupted in mid-plane ($y=0$) and mirrored
- fibres read out at top and bottom
- photodetectors + FE electronics + services in a "Readout Box"

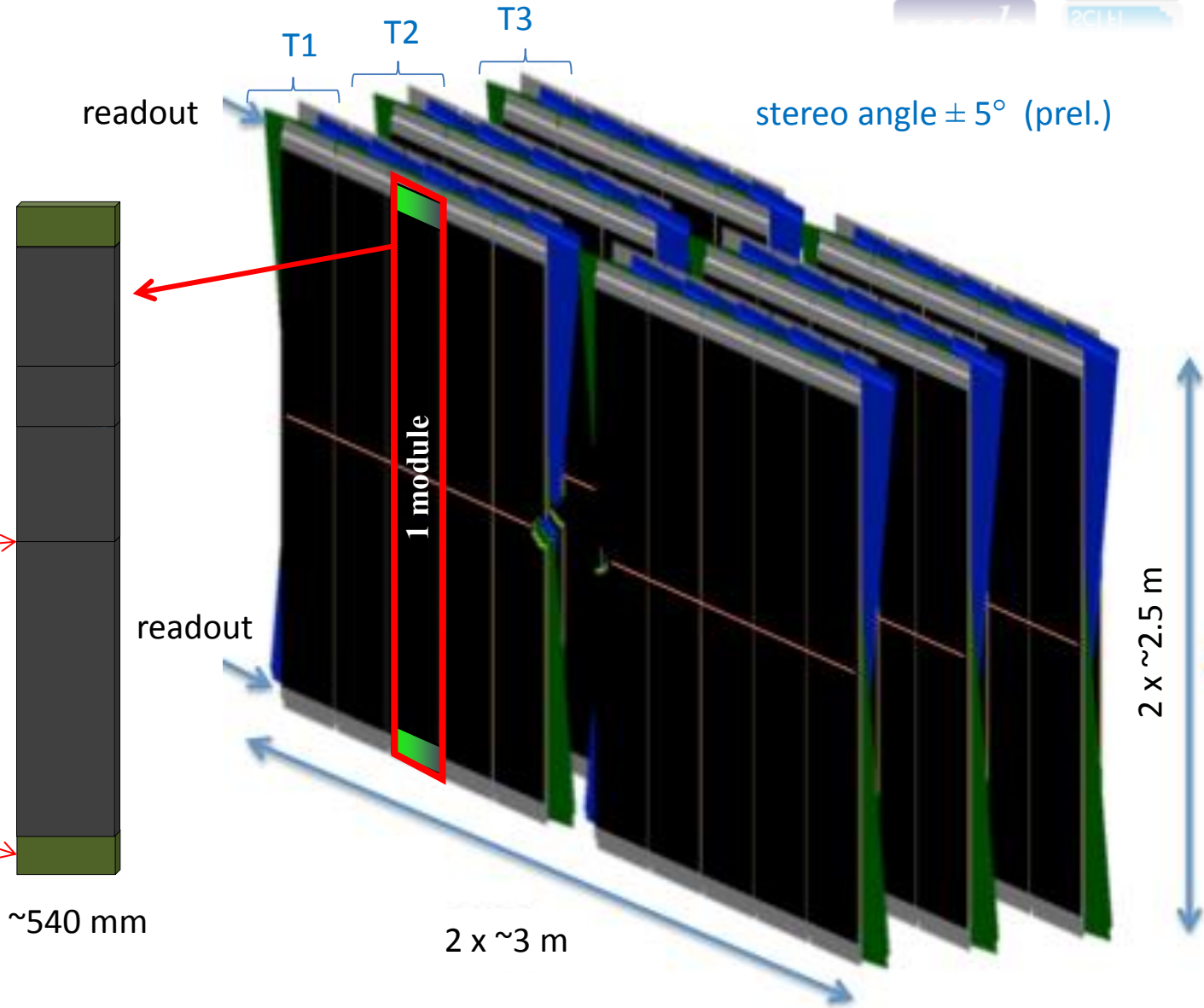

Material distribution X/X_0 of station T1 (with 4 planes X-U-V-X)

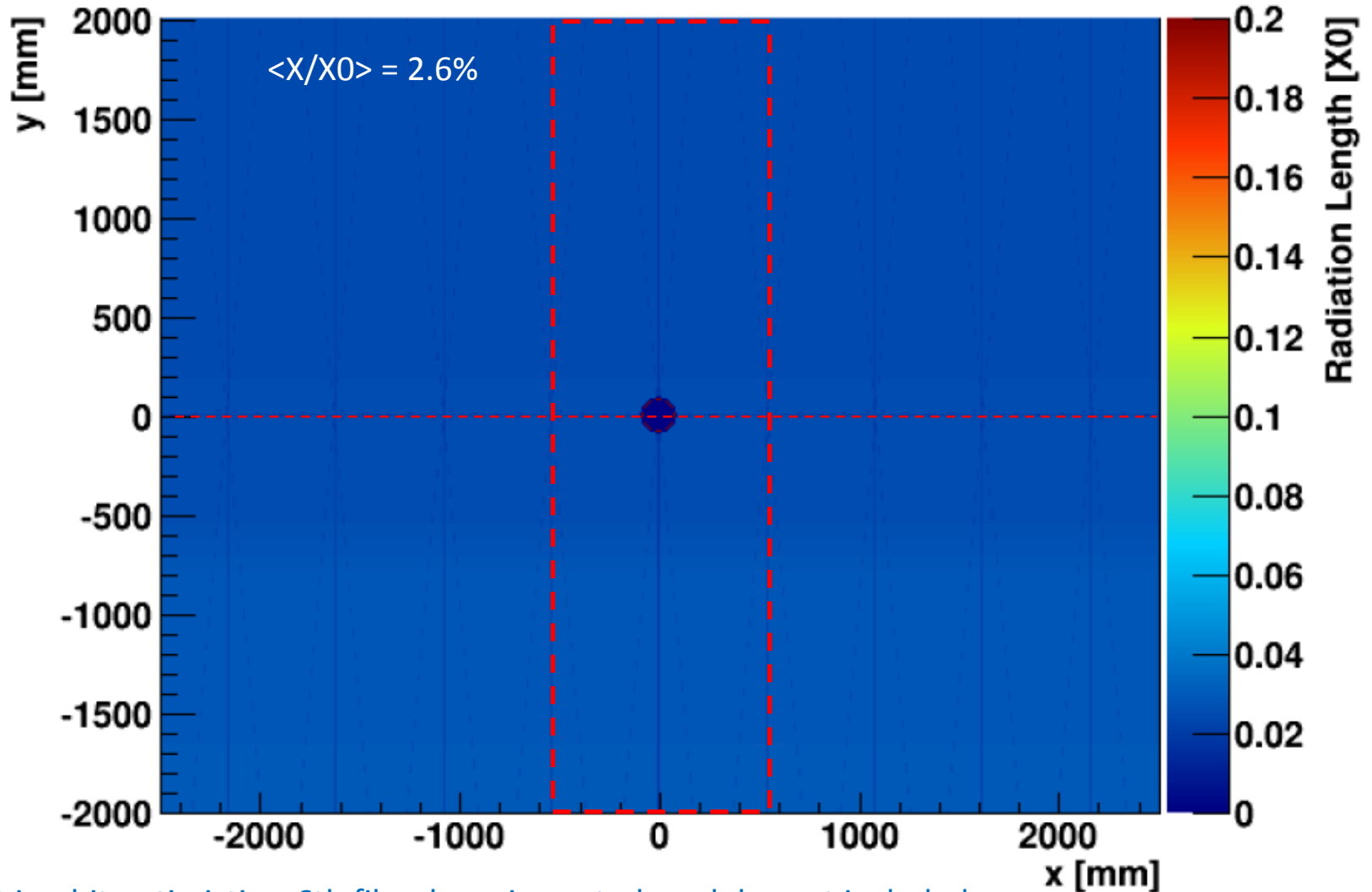

Plot is a bit optimistic: 6th fibre layer in central modules not included
Fibre end pieces in midplane ($y=0$) not included

Fibres and photodetectors

The SciFi tracker is following the technology developed by the Aachen group for the **PERDaix detector** (prototype balloon experiment)

B. Beischer et al., A 622 (2010) 542–554
G.R. Yearwood, PhD thesis, Aachen, 2013

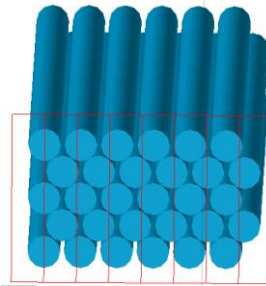
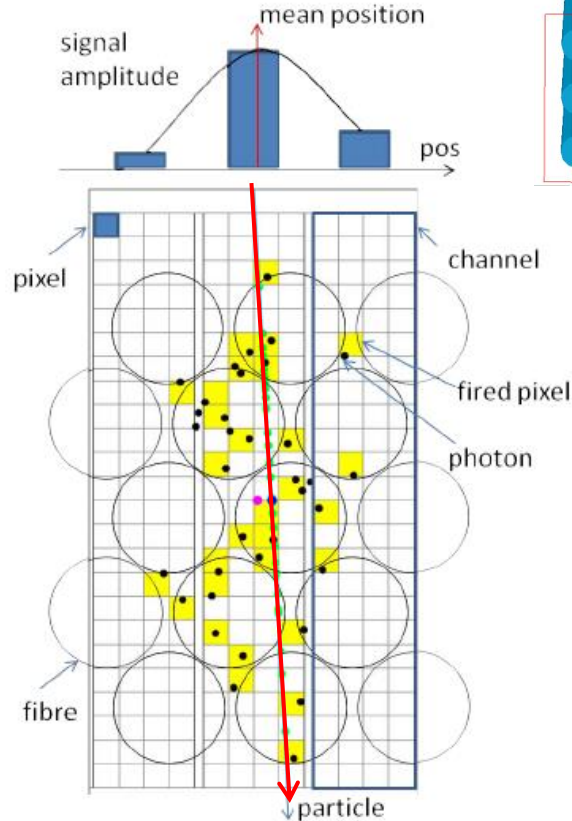

PERDaix: 860 mm (L) x 32 mm (W) bi-layer module in stereo geometry.

- 5 staggered layers of $\varnothing 250 \mu\text{m}$ fibres form a ribbon (or mat)
- Readout by arrays of SiPMs. 1 SiPM channel extends over the full height of the mat.
- Pitch of SiPM array should be similar to fibre pitch. Light is then spread over few SiPM channels. Centroiding can be used to push the resolution beyond $p/\sqrt{12}$.
- Hits consist of clusters with typical size = 2. This is an efficient approach to suppress noise hits (=single pixels in 1 channel).

Some PERDaix test beam results (CERN T9, 2009)

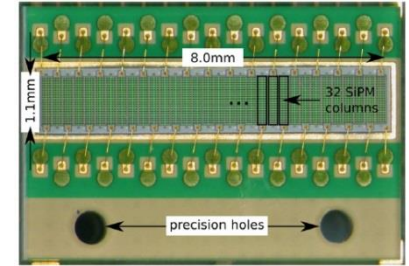
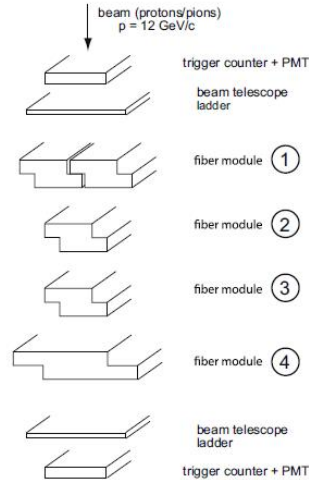
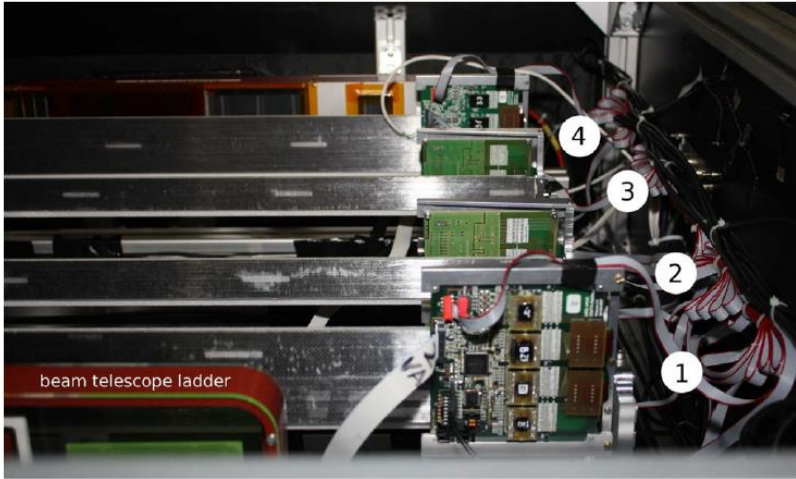

- 32 channel SiPM array from Hamamatsu.
- Readout by IDEAS VA_32 ($\tau_s=75$ ns) + 12 bit ADC

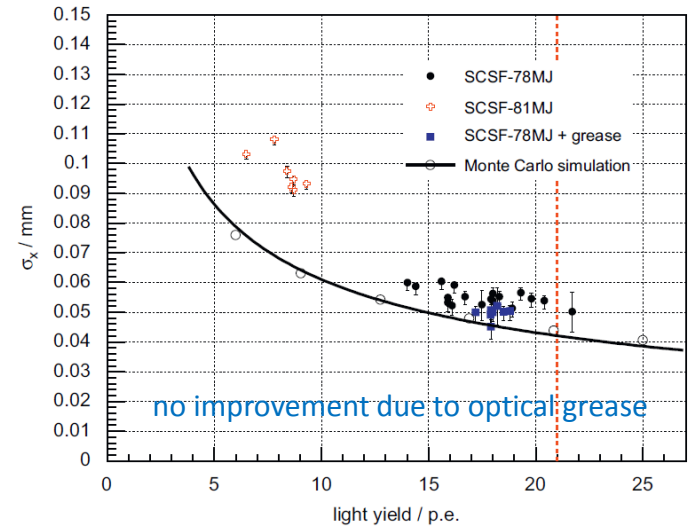
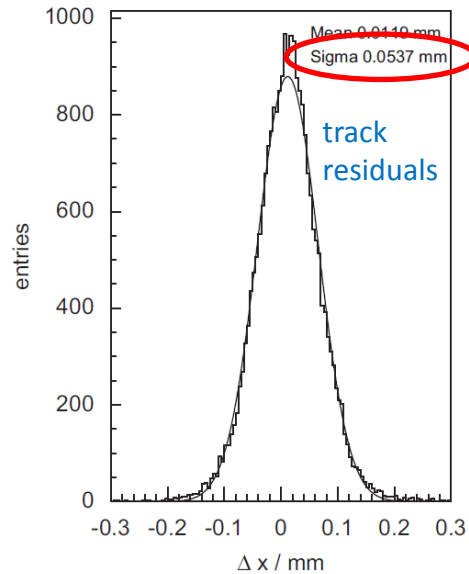
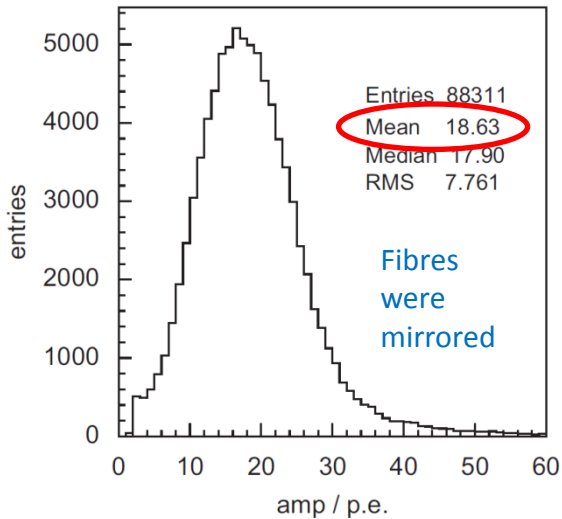

LHCb SciFi module design

What is different from PERDaix?

	PERDaix	LHCb SciFi
Module length	39.5 / 86 cm	2 x 250 cm
Detector surface	0.25 m ²	~360 m ²
Radiation	none	10 ⁴ Gy, 10 ¹² n/cm ²
Multiplicity	1	A few hundred
Readout	rel. slow	40 MHz

LHCb SciFi main design parameters

- Round double cladded fibres of $\varnothing 250 \mu\text{m}$, L = 2500 mm, mirrored
- 13 cm wide fibre mats made of 5 (or 6) staggered layers.
- 4 mats are assembled on the same support structure and form a 54 cm wide module.
- Readout by arrays of SiPMs. 128 channels. Pitch of SiPM = 250 μm .

➔ >10,000 km of fibres

SciFi module

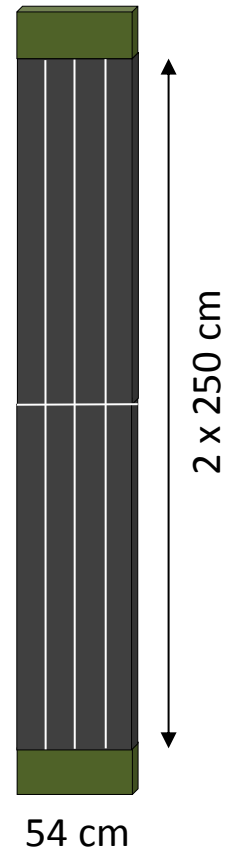

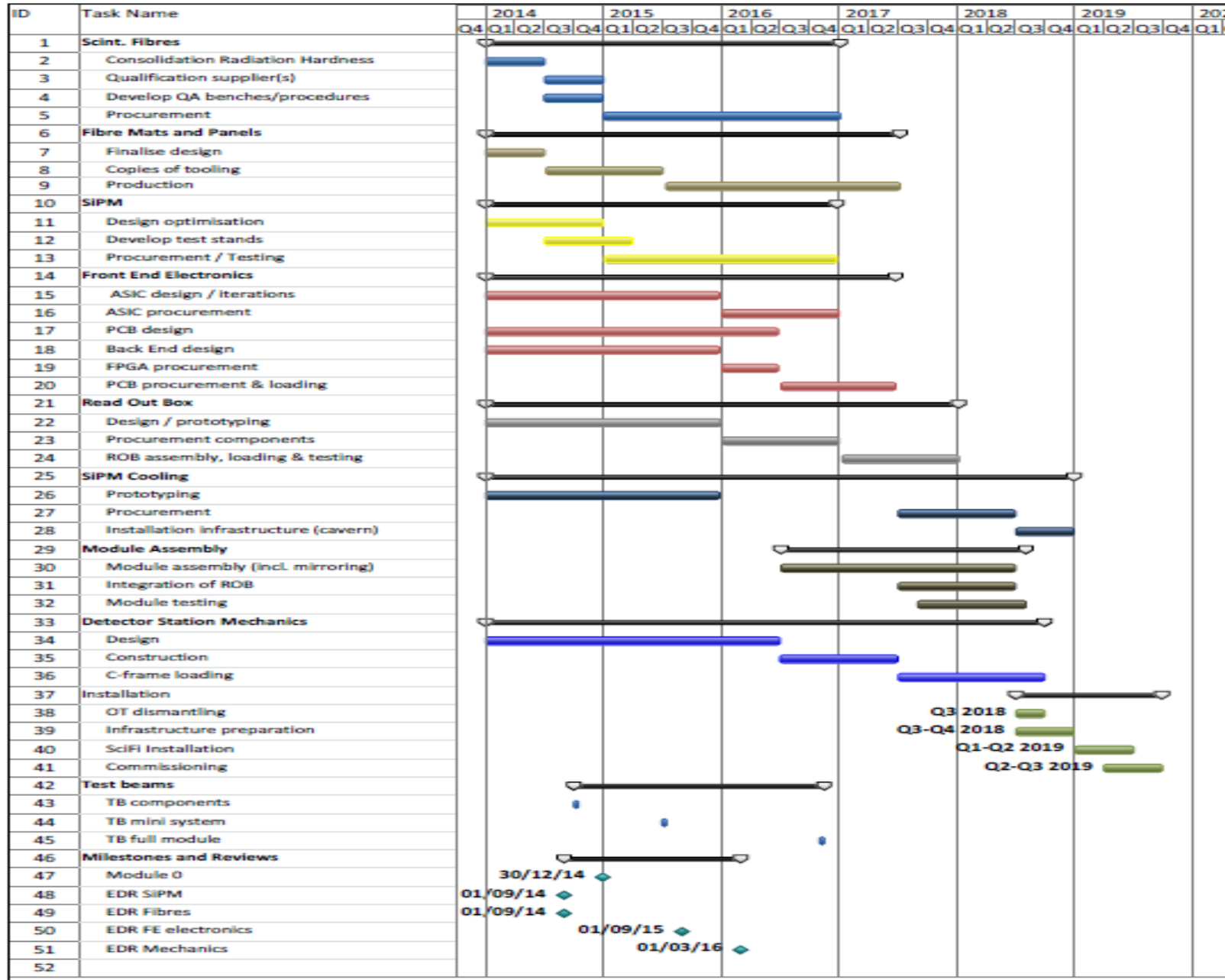

SciFi Tracker: participating institutes

- Brasil (CBPF)
- China (Tsinghua)
- France (LPC, LAL, LPNHE)
- Germany (Aachen, Dortmund, Heidelberg, Rostock)
- Netherlands (Nikhef)
- Poland (Warsaw)
- Russia (PNPI, ITEP, INR, IHEP, NRC KI)
- Spain (Barcelona, Valencia)
- Switzerland (CERN, EPFL)
- UK (Imperial College)

LHCb SciFi R&D: Challenges, strategies, status

- Geometrical precision
- Get enough light
- Fast readout with manageable data volume
- Survive the radiation
- Optimize detection efficiency vs ghost rate

Geometrical precision

- Fibre mats are produced by winding fibres, layer by layer, on a fine-pitch threaded wheel

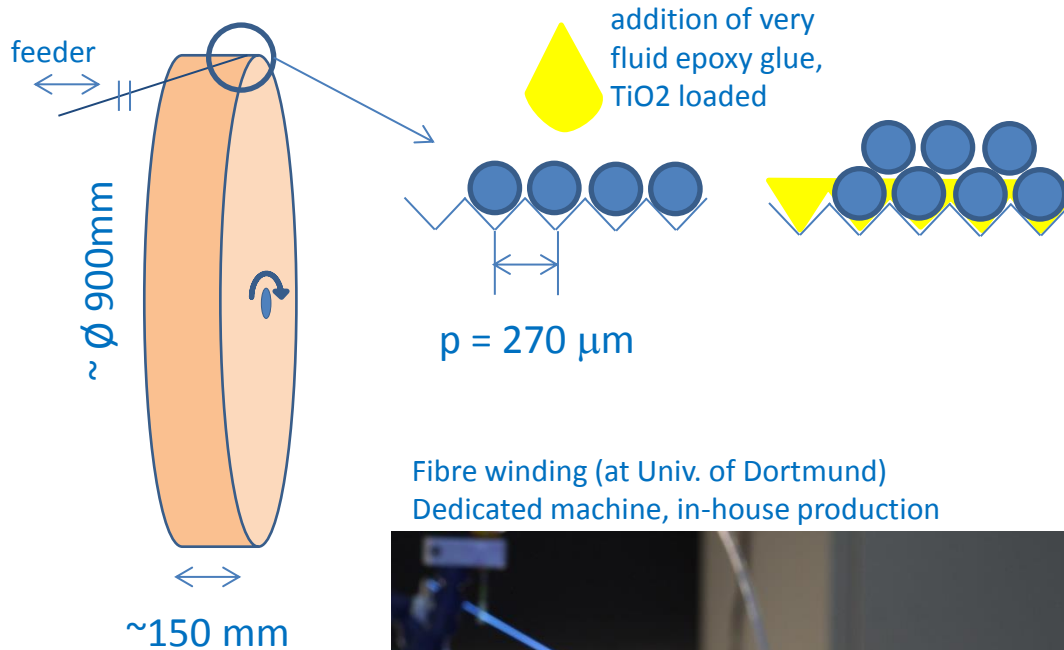

Fibre winding (at Univ. of Dortmund)
Dedicated machine, in-house production

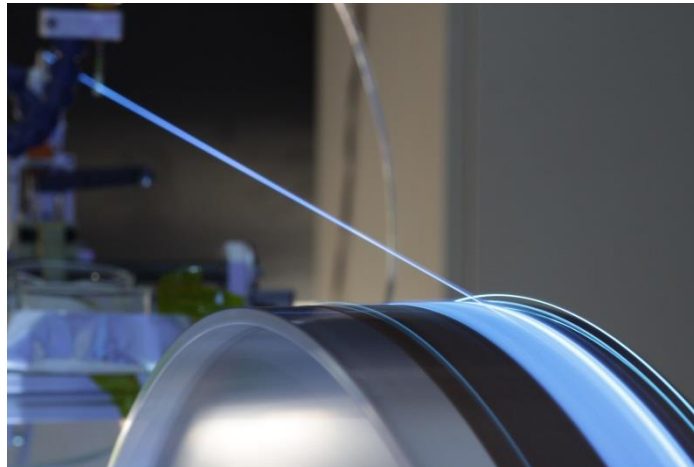

Test winding (at Univ. of Aachen)
Use of a large CNC lathe.



Geometrical precision

- Alternative technique: replace thread by a kapton film, structured with coverlay (© Dupont). PCB technique, R. de Oliveira.

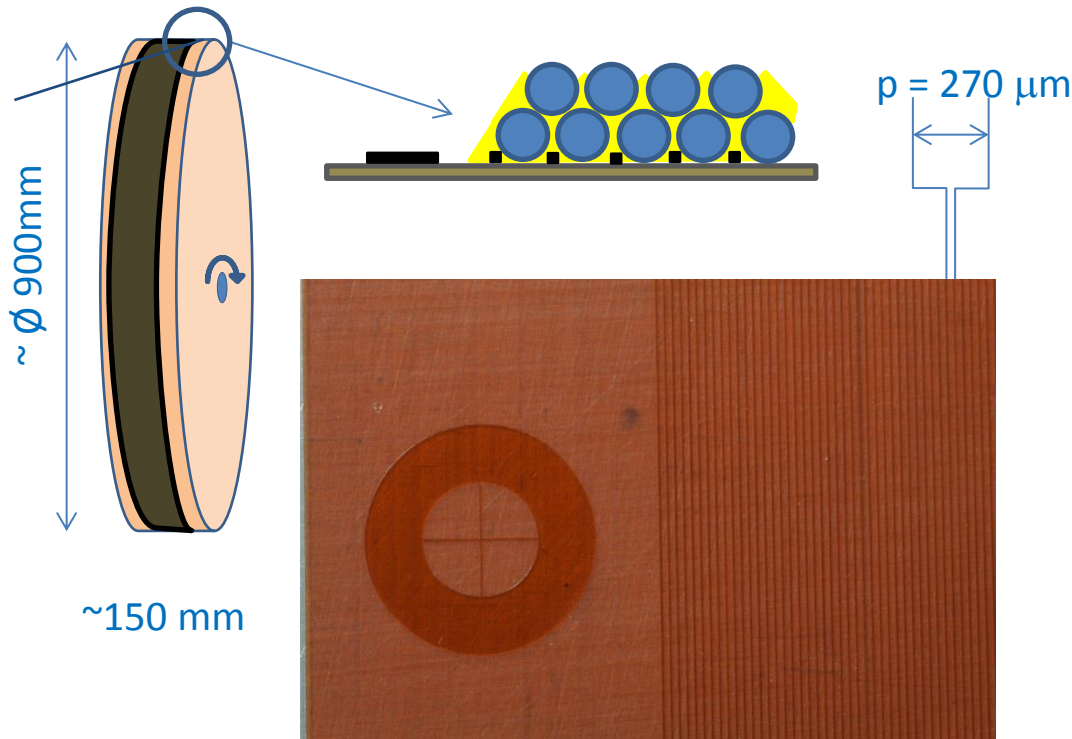

Kapton film becomes part of fibre mat.
Allows use of precise alignment marks.

3 m long and 16 cm wide Kapton film used for a full-size 6 layer mat (march 2014).



Inspection at CERN

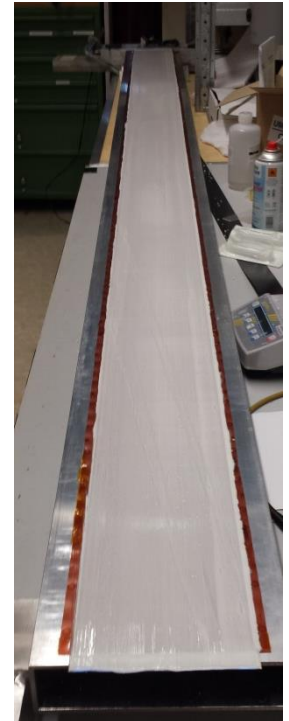

After winding at Univ. Dortmund

Scan of fibre mat end faces (after cut with diamond tool)



1.5 mm

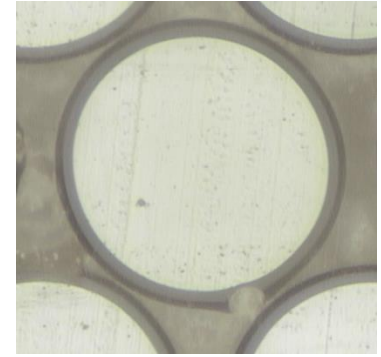

Optical 3D coordinate measurement machine (CMM) in PH/DT bond lab.

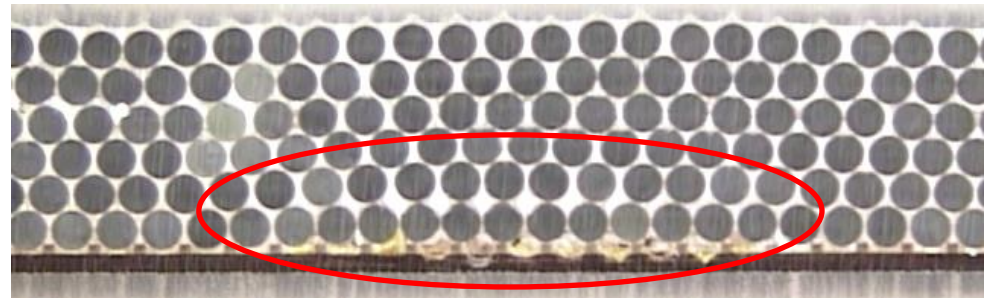

fibre diameter (mm)

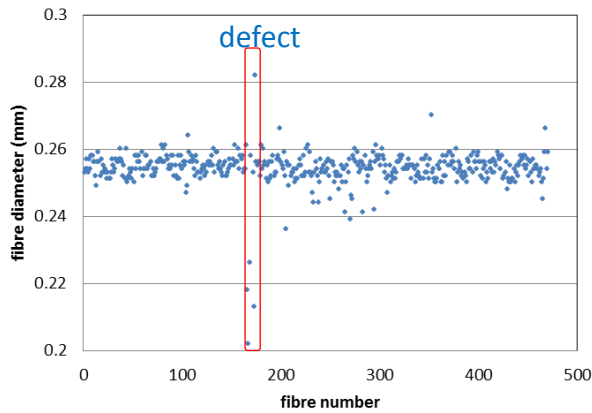

pitch x (mm)

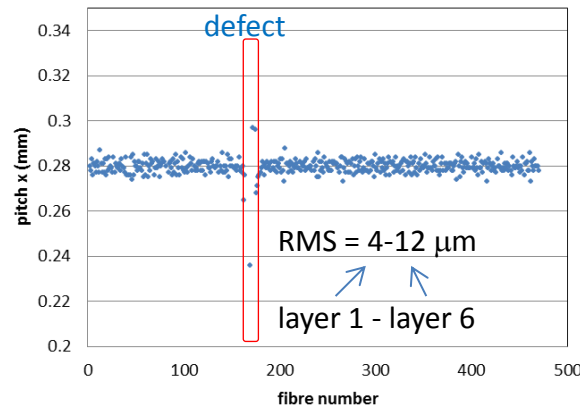

delta x (mm)

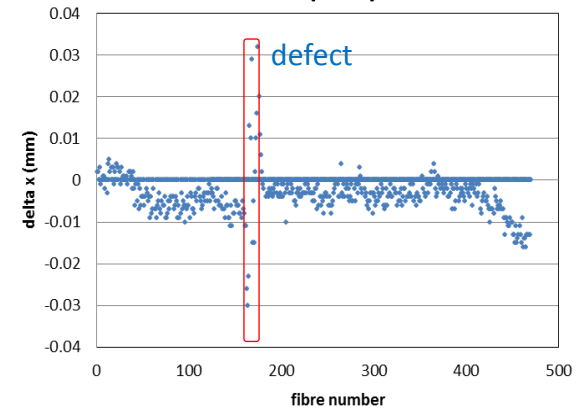

An important parameter: Fibre diameter profile (along fibre)

Plots by P. Hebler, Dortmund.

Over 99% of the length, the fibre diameter is within $250 \pm \text{few } \mu\text{m}$

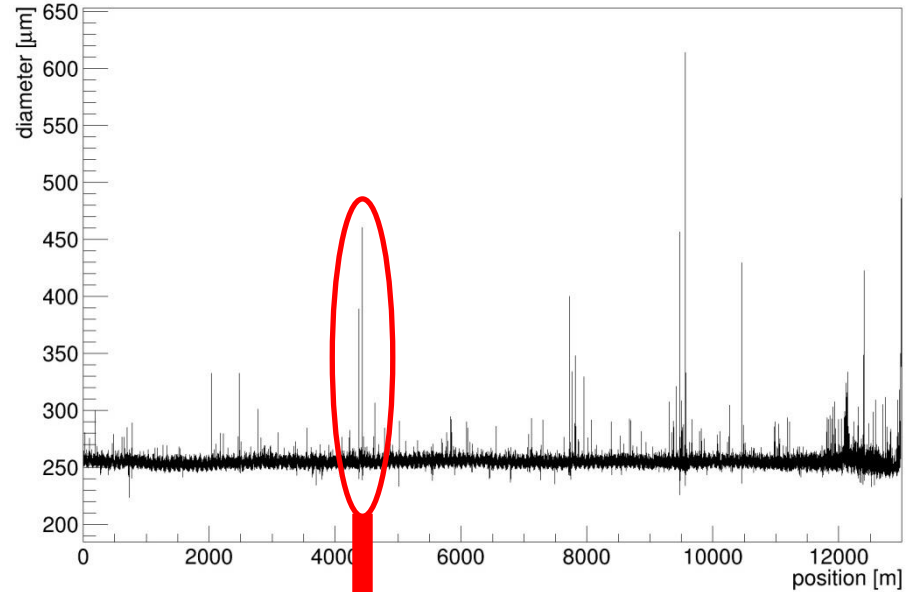
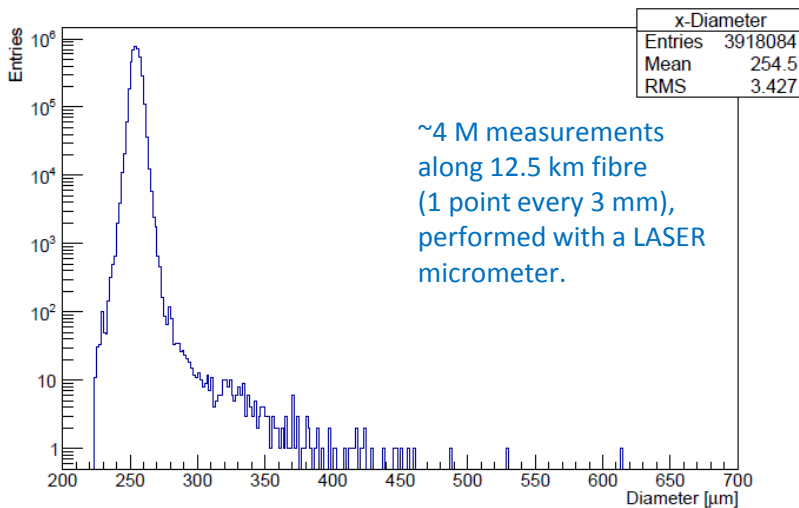

However, typically once per km, the fibre diameter increases beyond acceptable limits ($300 \mu\text{m}$). Problem worked on by producer but not fully understood.

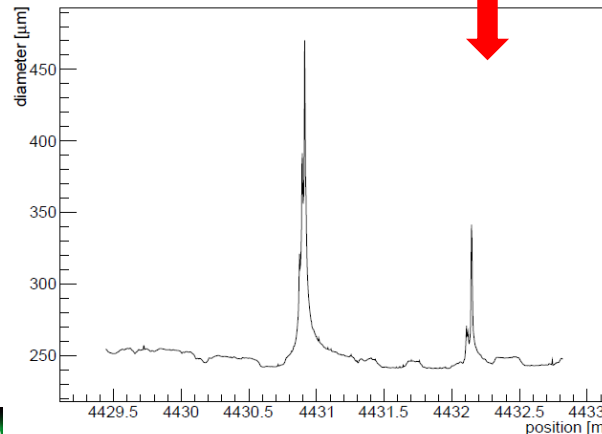

These sections are manually removed during winding process, at the position where the mat is anyway cut. Costs time (5') but no performance.

Maintaining the intrinsic fibre precision when building a full detector.

Require overall precision and stability: $O(100 \mu\text{m})$

- Quite non-trivial! Subject of current studies.
- Good ideas and promising results on prototype level exist.

Alignment chain:

- Fibres inside mat \rightarrow thread / coverlay
- Sides and end faces of mats need to be cut \rightarrow rely on epoxy-pins on backside of mat (or markers on coverlay).

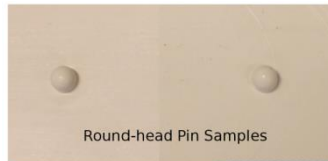

- Mount mats on support panels \rightarrow rely on epoxy pins or mat precision
- Mount support panels in C-frames \rightarrow alignment pins.
- Offline alignment 😊

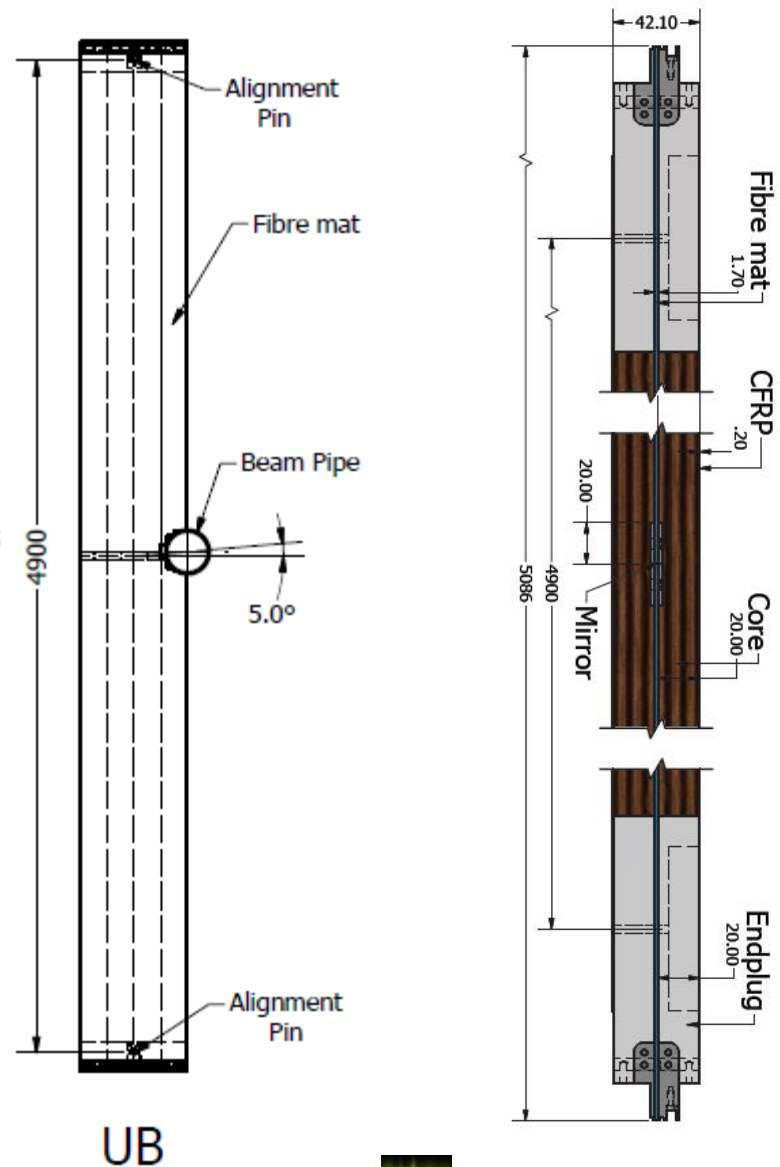

Get enough light → maximise PDE of SiPM

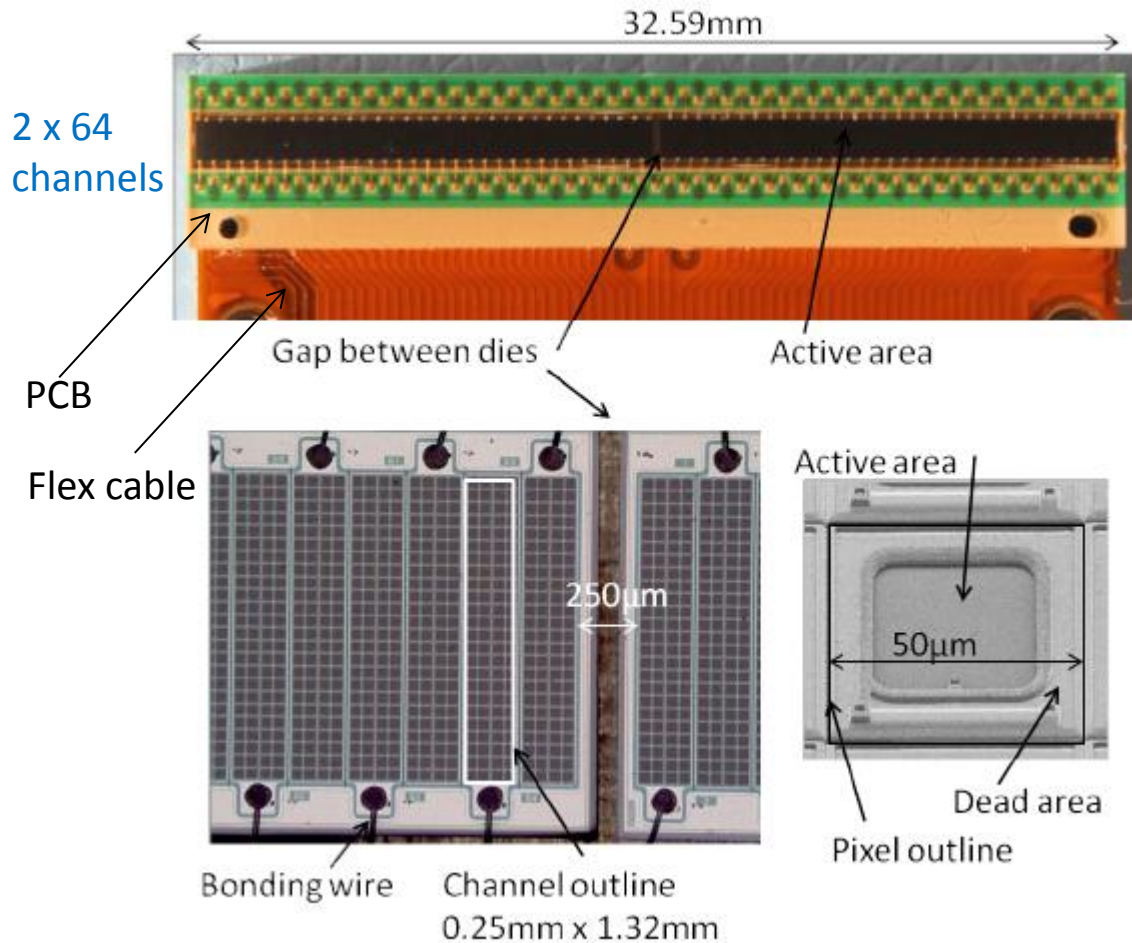

We co-develop with **Hamamatsu (JP)** and **KETEK (DE)** 128-channels SiPM arrays, with very similar dimensions.

Photon detection efficiency

$$PDE = QE \cdot \epsilon_{\text{geom}} \cdot \epsilon_{\text{avalanche}}$$

$$\downarrow$$

$$= f(OV)$$

- ϵ_{geom} can be optimised by minimising the number of pixels.
- $\epsilon_{\text{avalanche}}$ can be increased by higher OV.
- Both effects must be counteracted by efficient trenches to control pixel-to-pixel cross-talk.

PDE and cross talk measurements at CERN and EPFL

with trenches

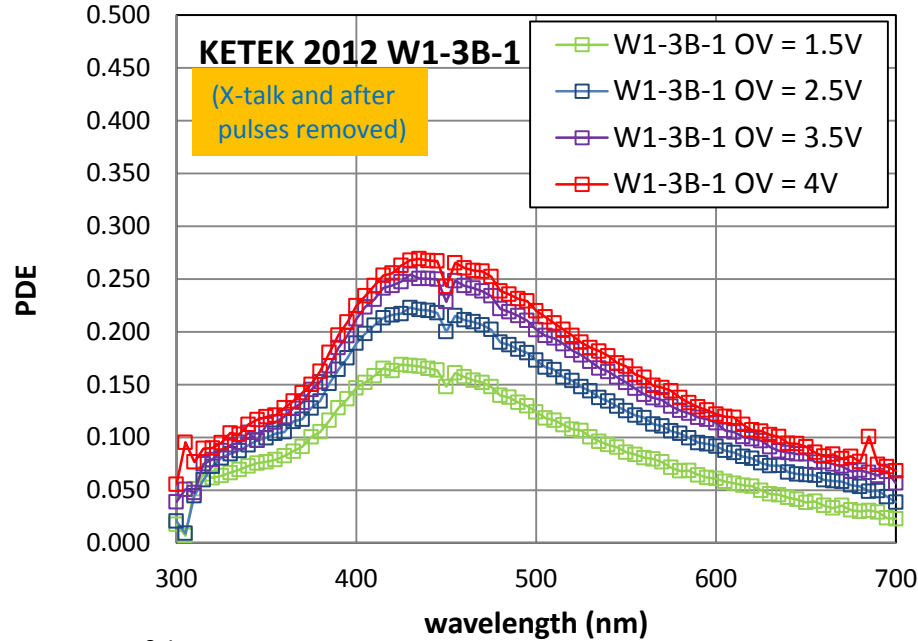

with new trenches

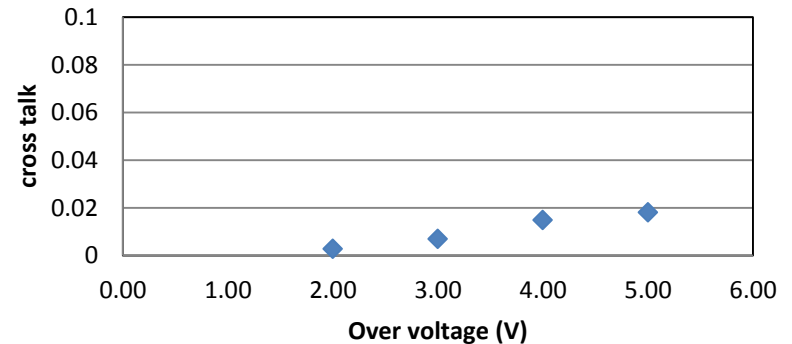
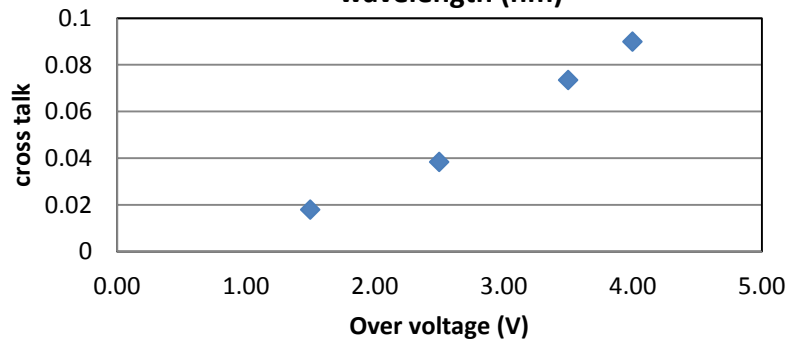
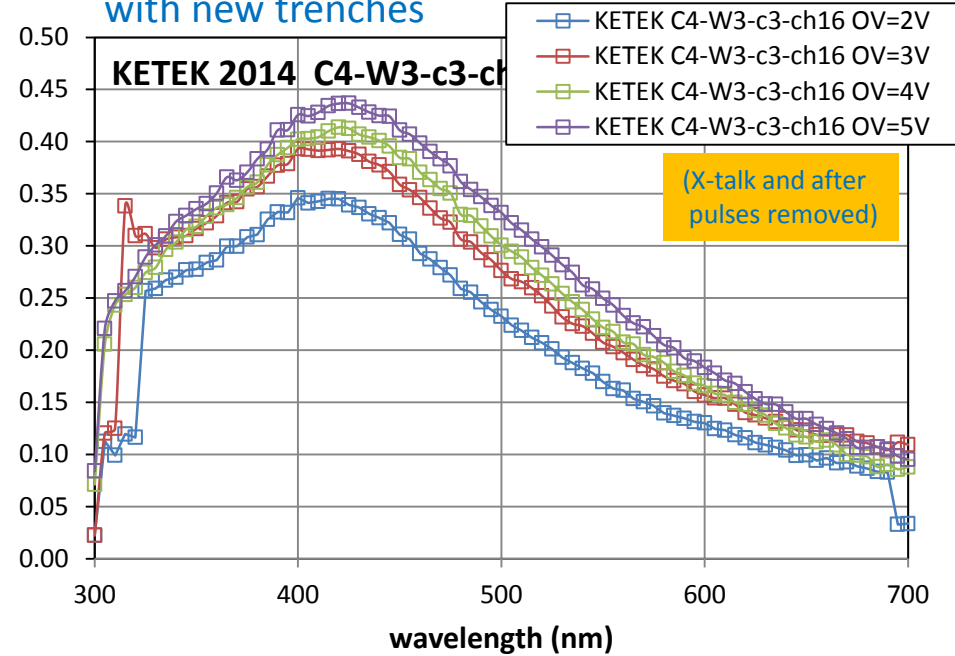

Expect also new Hamamatsu devices in autumn!

Matching between KETEK PDE and scintillation spectrum (after irradiation) isn't perfect yet.

KETEK 2014 C4-W3-c3-ch16

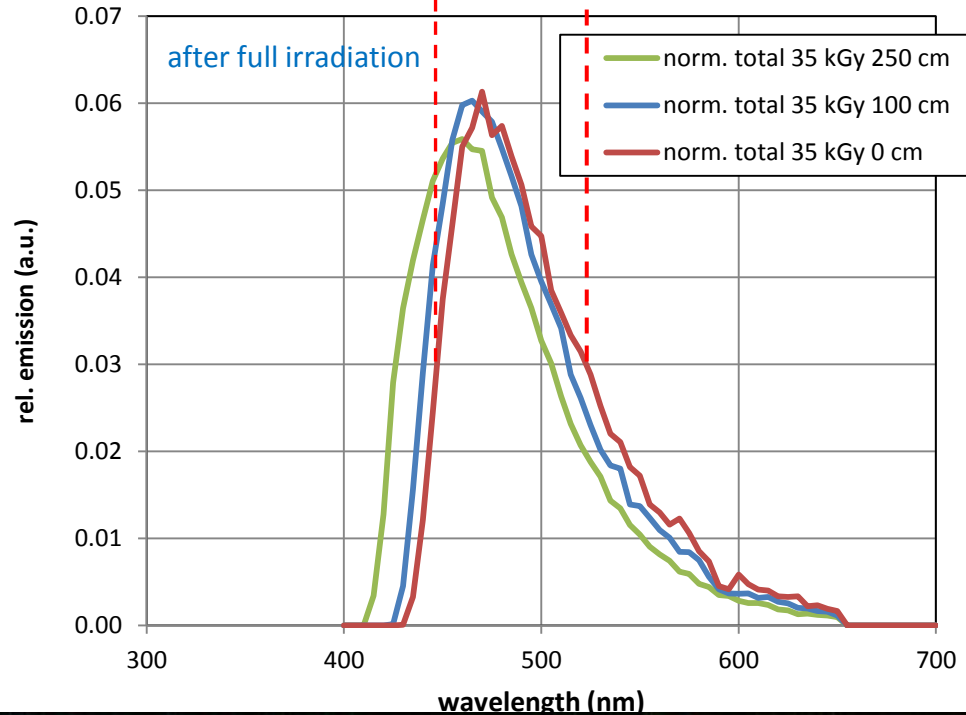
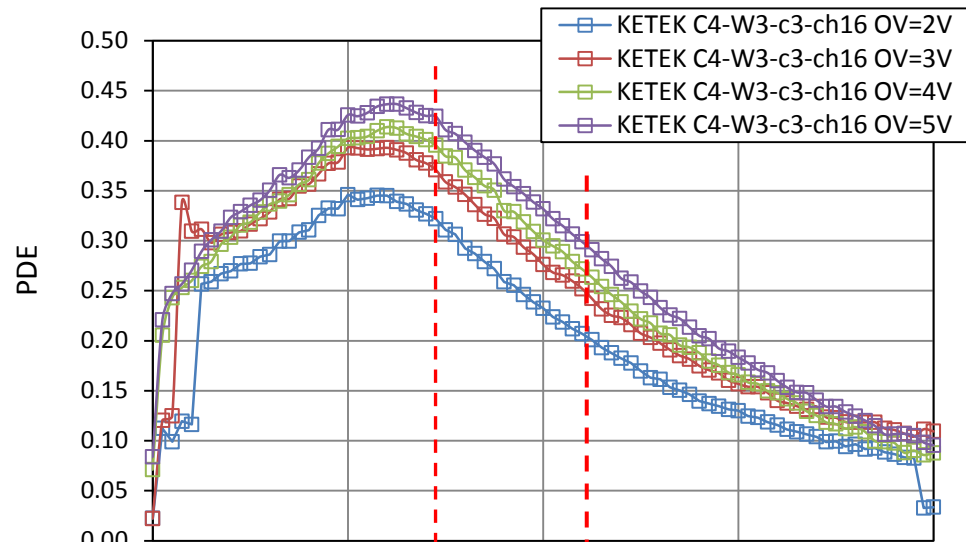

Close to SiPM

Mid plane

Get enough light → produce high quality mirror at non-read fibre end

50% of the scintillation light is emitted in the wrong hemisphere.

We studied three different mirror technologies

- Aluminised mylar foil
- 3M Extended Specular Reflectance (ESR) foil
- Aluminium thin film coating (TFC)

and measured the intensity gain (mirror/no mirror*)

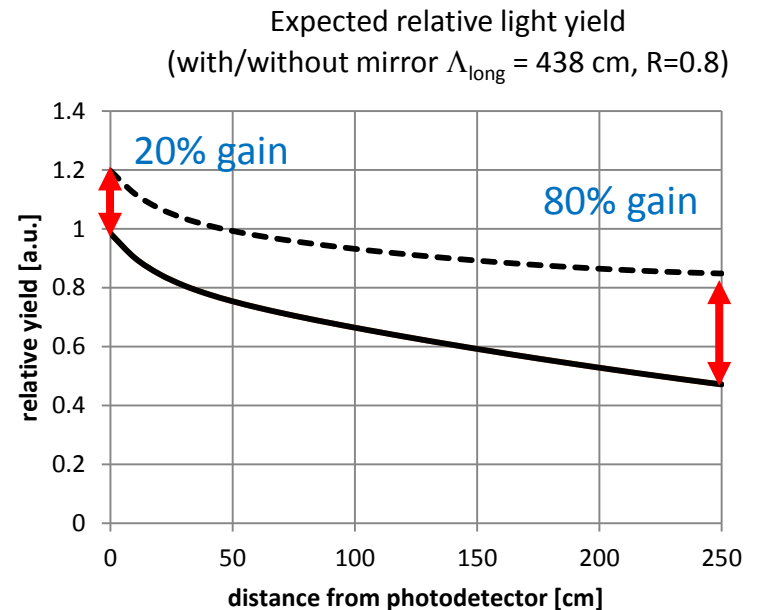
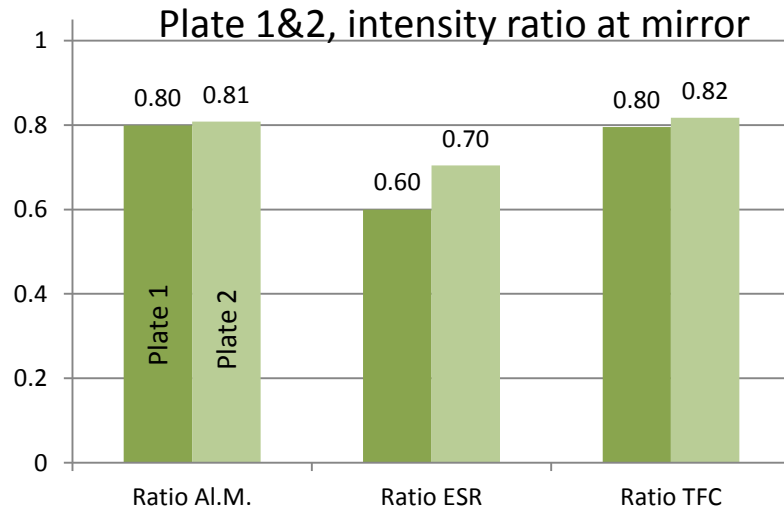

It remains unclear why ESR results are so low. Would have expected \geq Al. Mylar.

We checked for possible influence of angle of incidence as well as glue type. No change.

Get enough light → maximise fibre attenuation length

CERN set-up for measurement of attenuation length

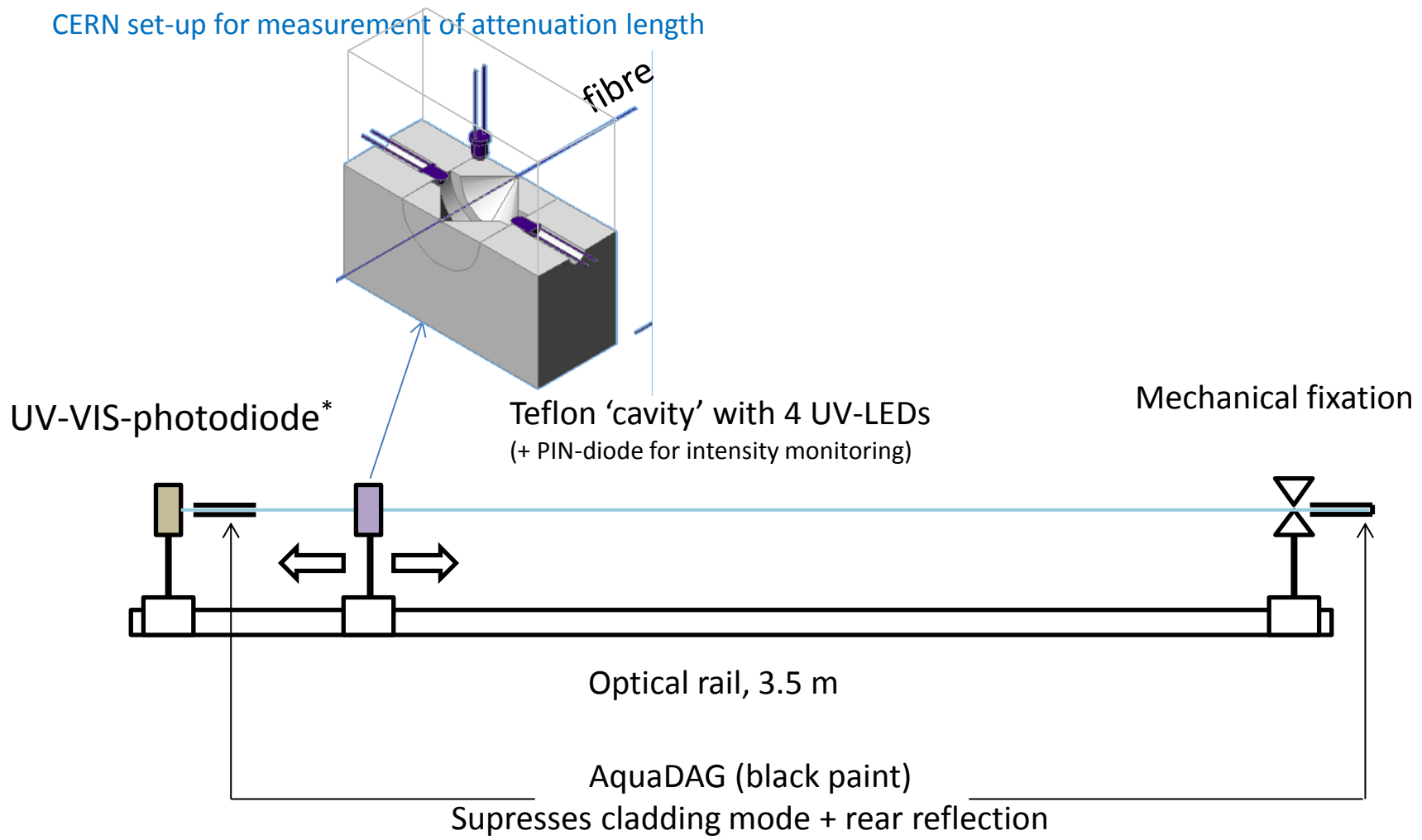

*May be replaced by a SiPM, to have correct sensitivity characteristics.

Measurements of 8 spools + older Dortmund sample (unknown Lot no.)

KURARAY SCSF-78, 250 μm , double cladde(d)

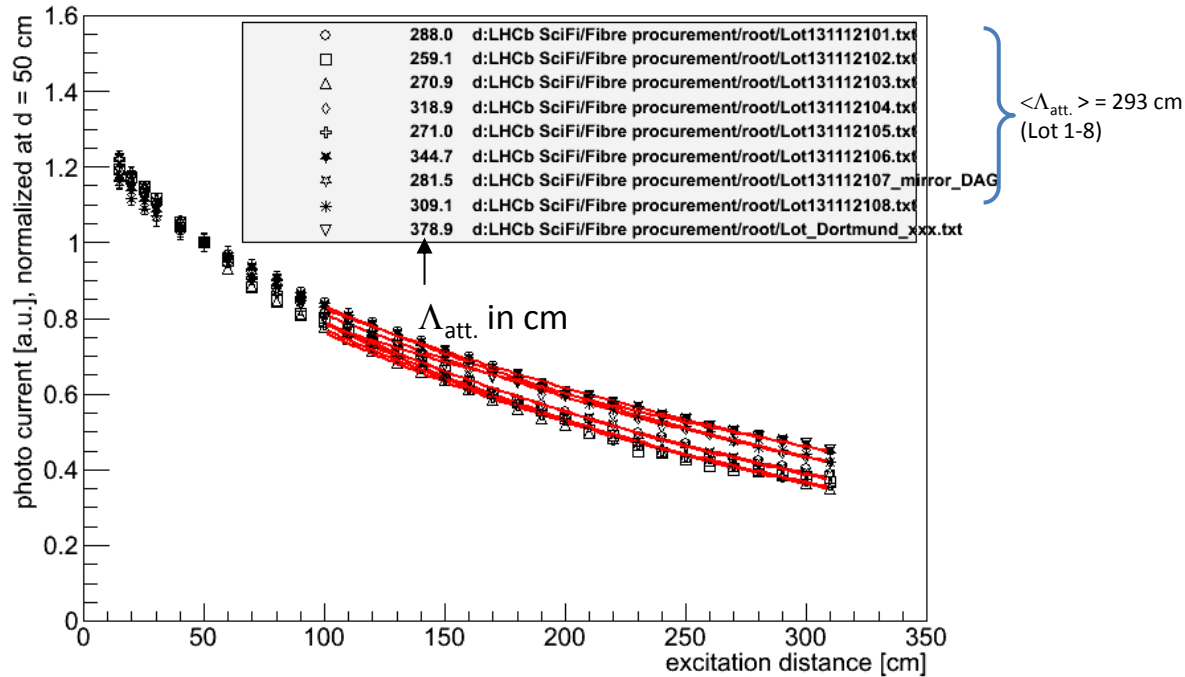

We are currently investigating with Kuraray whether lower or higher concentrations of dopants have a sizable impact on Λ or whether we have to live with $\Lambda \sim 3\text{-}4 \text{ m}$.

Side remark: We are also maintaining / building up relations to 2 other potential fibre producers: Saint-Gobain (Bicron), ELJEN Technologies (new in the SciFi market).

Fast readout with manageable data volume

- ~0.6 M channels
- 40 MHz readout rate
- Signal propagation time up to $5\text{m} \cdot 6\text{ns/m} = 30\text{ns}$ → some spill over to next BC
- No adequate (fast, low power) multi-channel ASIC available

LHCb develops its own ASIC, called PACIFIC, with 128 channels (130 nm CMOS)

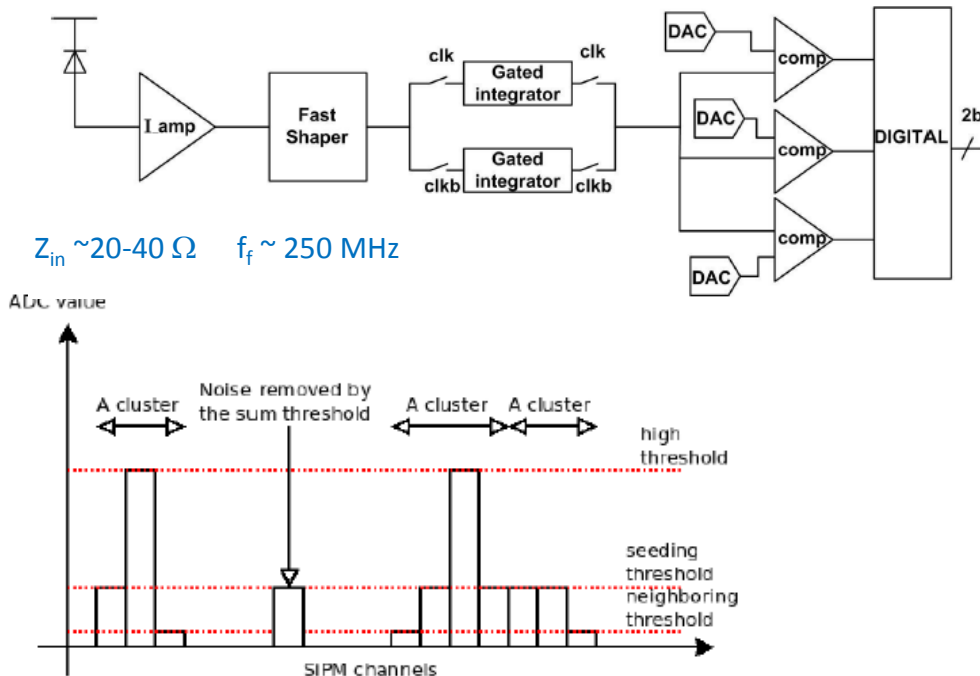

3 hardware thresholds (=2 bits)

- seed
- neighbour
- high

plus a sum threshold (FPGA) are a good compromise between precision ($<100 \mu\text{m}$), discrimination of noise and data volume.

Compared to analog (6 bit) readout, expect resolution to degrade from ~ 50 to $60 \mu\text{m}$. Marginal impact on p-resolution.

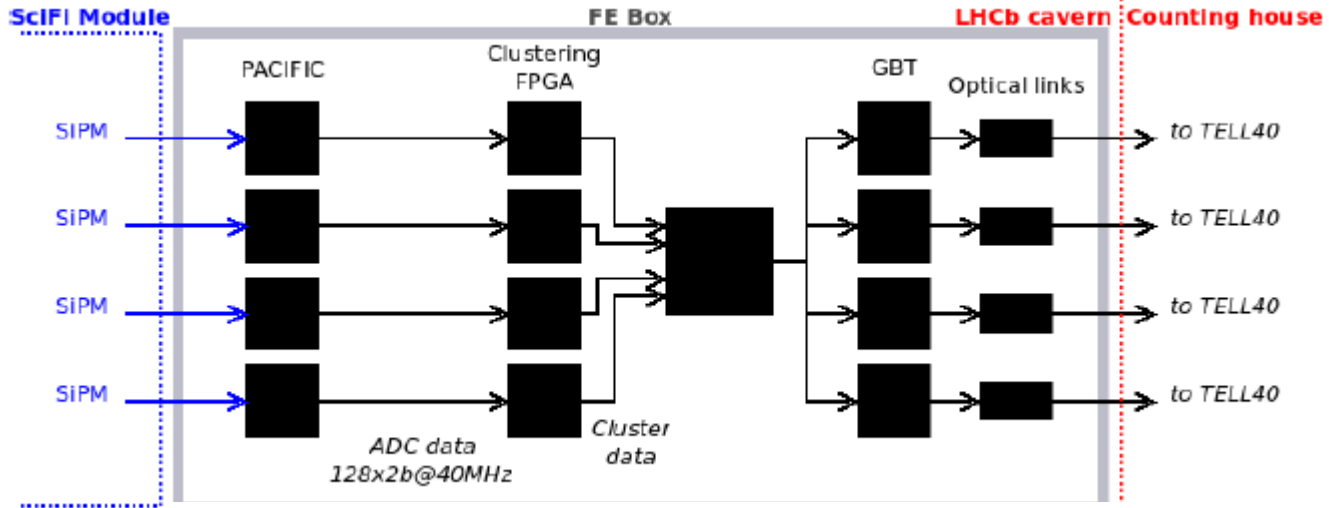

Current layout of motherboard
For 8 x 128 channels.

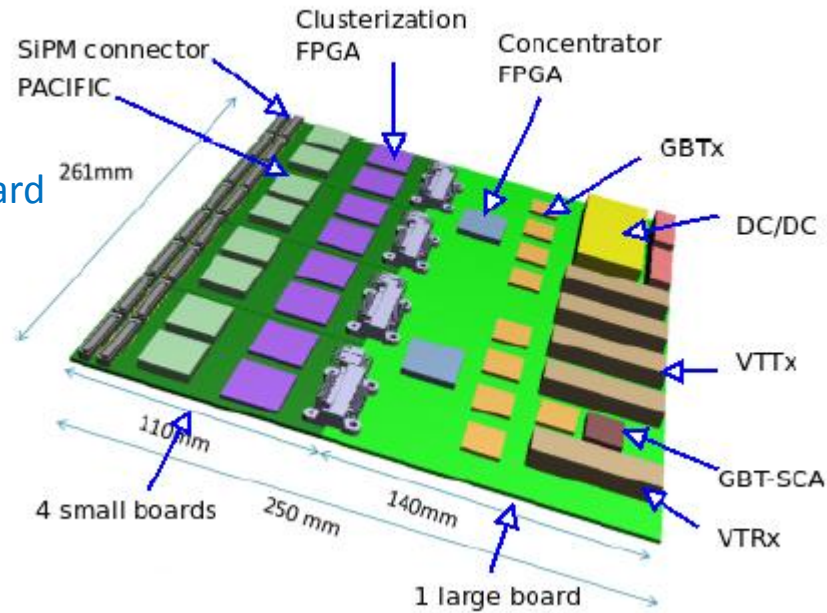

Survive the radiation

Neutrons:

- The SiPMs are exposed to $1.2 \cdot 10^{12} n_{1\text{Mev.eq.}}/\text{cm}^2$ (50 fb^{-1})
- A detailed FLUKA simulation showed that shielding (Polyethylene with 5% Boron) can halve this fluence \rightarrow tests so far done for $6 \cdot 10^{11}/\text{cm}^2$.
- The SiPMs need to be cooled. Our default working point is -40°C . Noise reduced by factor ~ 64 .

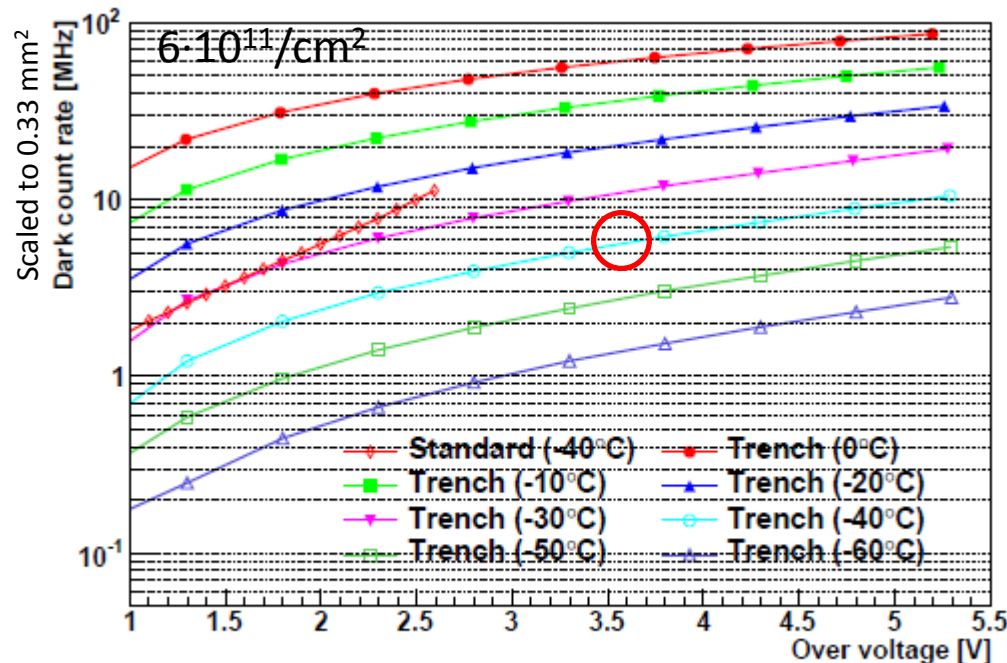
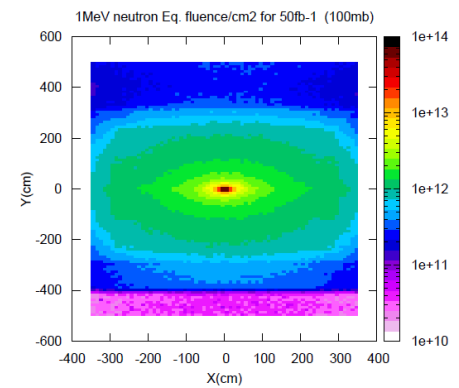

- Dark counts are primary noise source.
- Keep pixel-to-pixel cross-talk low \rightarrow avoid double-noise hits (which can seed noise clusters)

(The expected neutron fluencies don't appear to be a problem for the fibres (to be better verified!)).

Hamamatsu 2013 technology (single channel devices)

SiPM cooling in Readout Box

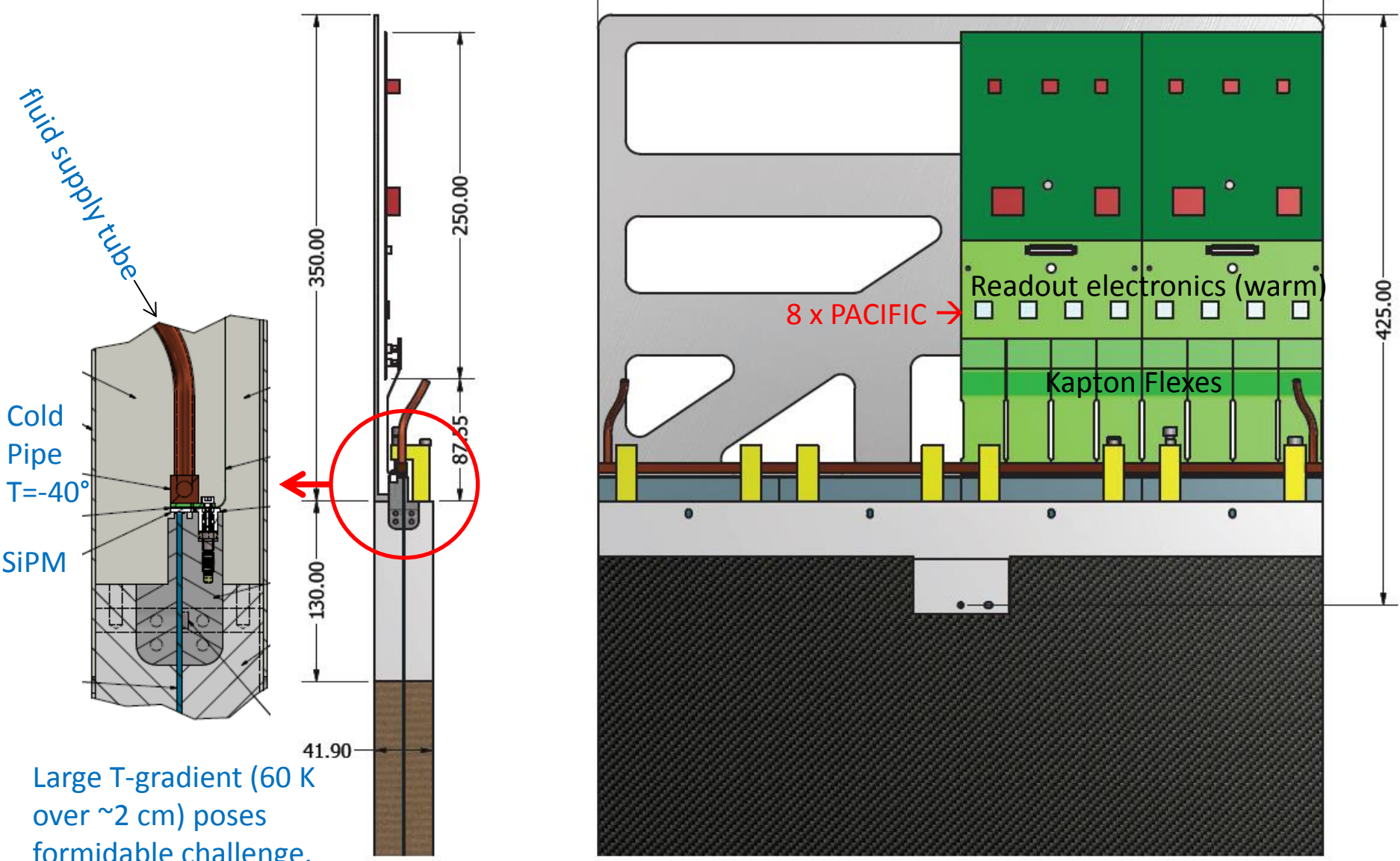

Large T-gradient (60 K over ~2 cm) poses formidable challenge.

Survive the radiation

Ionizing dose:

- The fibres get significantly damaged in the central part of the detector (up to 35 kGy)

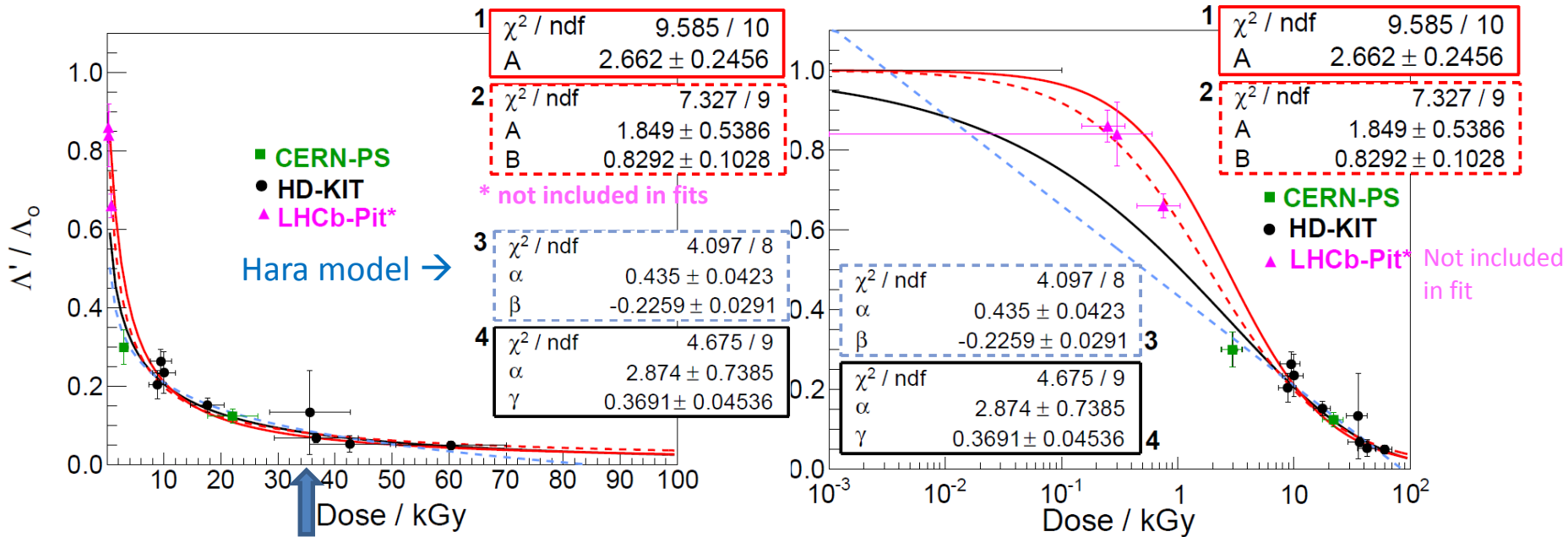
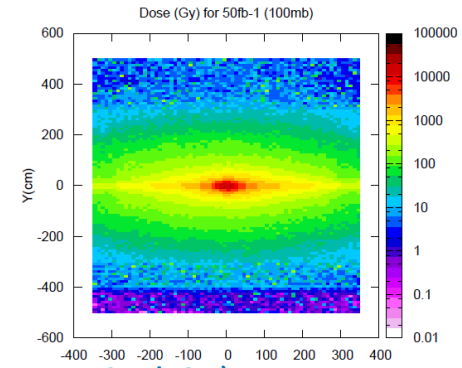

Radiation damage $\Lambda(D)/\Lambda_0$ versus Dose is highly non-linear.

Hara model: $\Lambda(D)/\Lambda(0) = \alpha + \beta \log(D)$

K. Hara et al., NIM A411 (1998), no. 1 31 .

Describes our data well, but has some weaknesses (can't include D=0, can become negative)

There is no generally accepted model → **Need more low dose data.**

Survive the radiation

Fibre annealing?

- Can we hope for some annealing effects ? Controversially discussed in literature. But also non-agreeing observations in Heidelberg (yes) and at CERN (no).
- 6 fibre layers in the central part will provide safety margin.
- Ultima ratio: be prepared to replace some central detector modules after $n \text{ fb}^{-1}$.

Optimize detection efficiency vs ghost rate

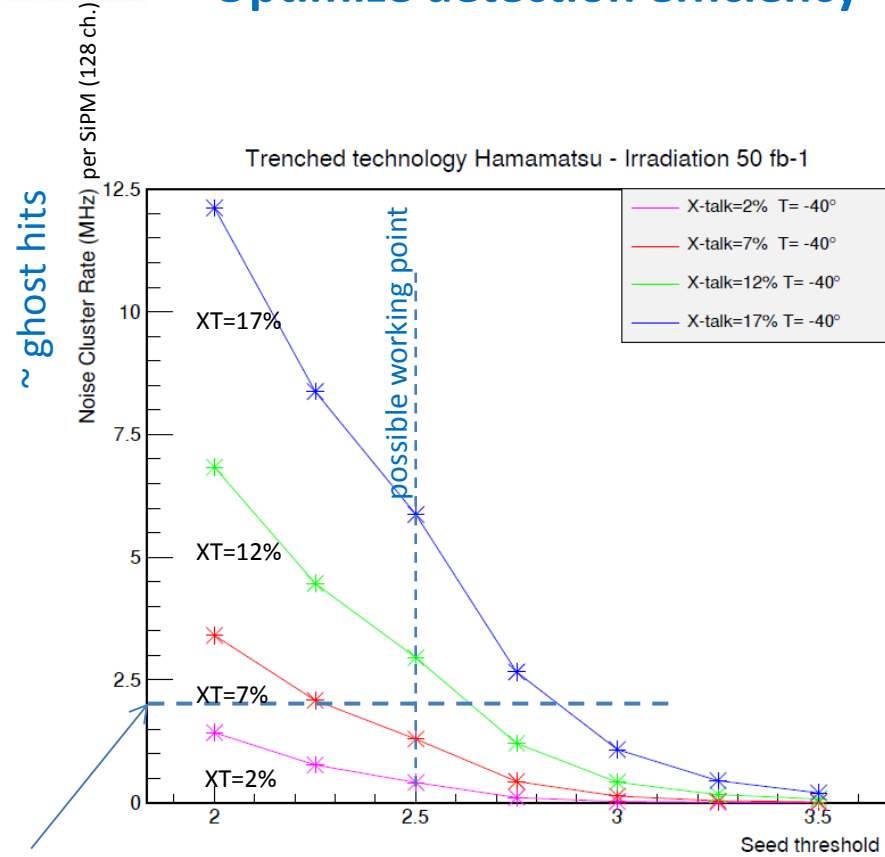

Seed = charge (in p.e.) of a SiPM channel to launch a cluster search

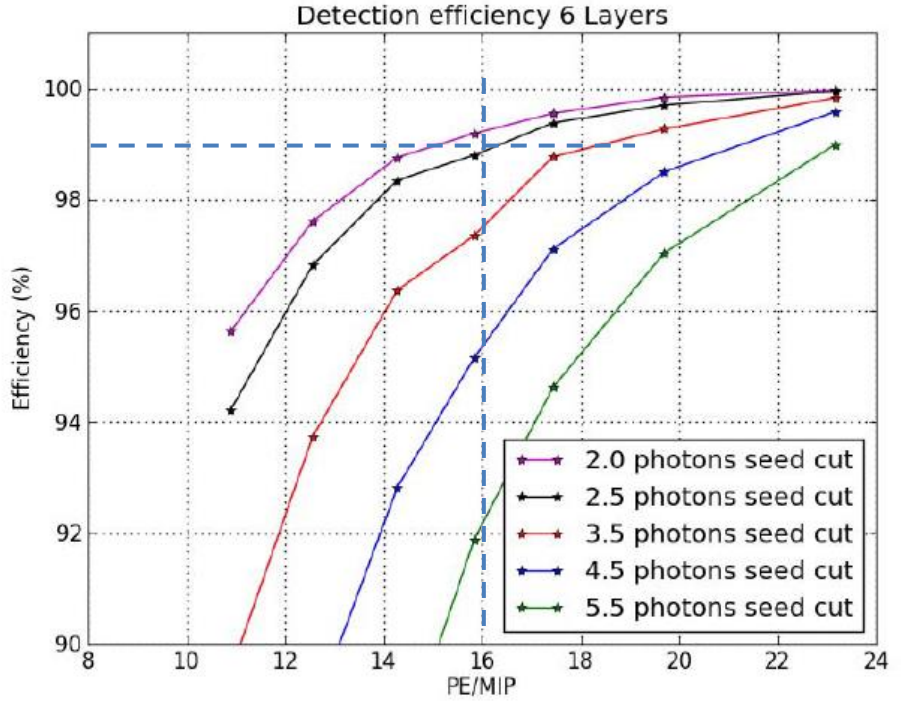

Total cluster charge (in p.e.) for a MIP hit.

Need 16 p.e to guarantee 99% detection efficiency (in single module).
12 p.e. give 96%

Need X-talk <10%

Where do we stand ?

- **Fibre modules** Learned how to make **13 cm wide and >2.5 m long fibre mats**. Current focus: machining and precision assembly of mats on panels. Aim to test them in SPS beam in autumn.
- **SiPMs** 64-ch. SiPM arrays from Hamamatsu and KETEK successfully tested. First 128-ch. arrays from KETEK look promising. Expect new arrays from Hamamatsu in autumn. **Increased PDE and(!) reduced XT.**
- **RO electronics** Single channel of PACIFIC being tested. 8-channel version submitted a few days ago.
- **Design** Efforts for overall detector design, Readout Box, mechanics getting in full swing. Lots of challenges like beam pipe hole, cooling (insulation, condensation).
- **Production** Starting to think of tooling, logistics and QA. Mass production of fibre mats and modules will require sustained efforts and tight quality control.

Where do we stand and what can we expect?

Non-irradiated 2.5 m long 5-layer mat + 2011 technology SiPM array, measured with 1.5 MeV e^- in lab (from energy filtered Sr-90 source).

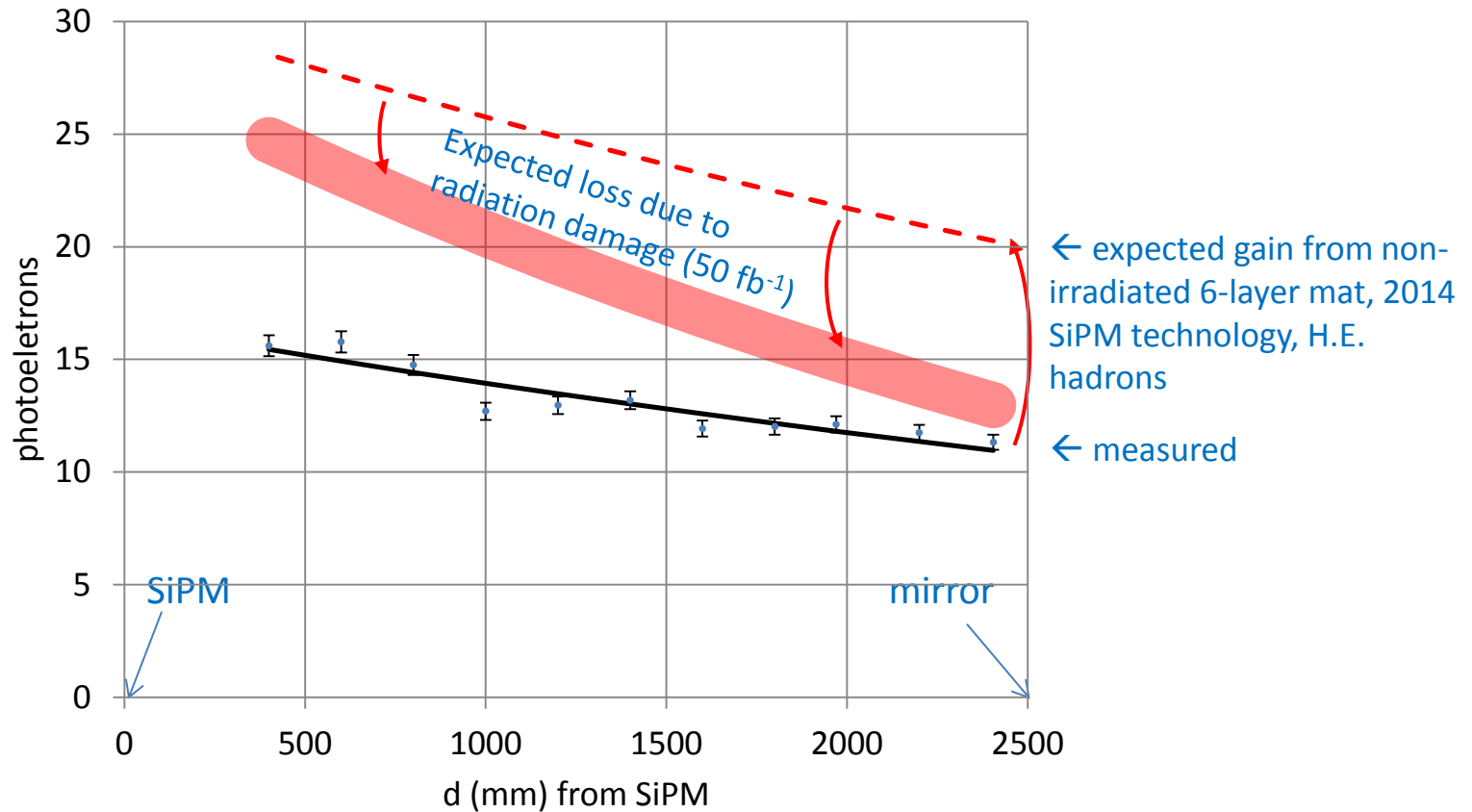

Summary and Outlook

- Scintillating fibre technology in combination with SiPM arrays allow building **large-area and low-mass tracking detectors with good spatial resolution**.
- As in every light based detector, lots of effort is spent in **producing enough photons** and **losing only few** of them.
- **Radiation is the main enemy**, both for the fibres (ionizing radiation) and the SiPMs (NIEL = neutrons). The radiation environment of LHCb is already pretty challenging.
- There was relatively little activity in scintillating fibres during the last two decades. Compared to e.g. silicon, the **fibre technology hasn't evolved very much** in terms of e.g. light yield, radiation hardness, attenuation length,
- Building a precise large-area fibre trackers is a **labour intensive endeavour** with lots of in-house production. Industrial partners producing high quality fibre mats would be welcome.

Back-up slides

H. Leutz, NIM A364 (1995) 422

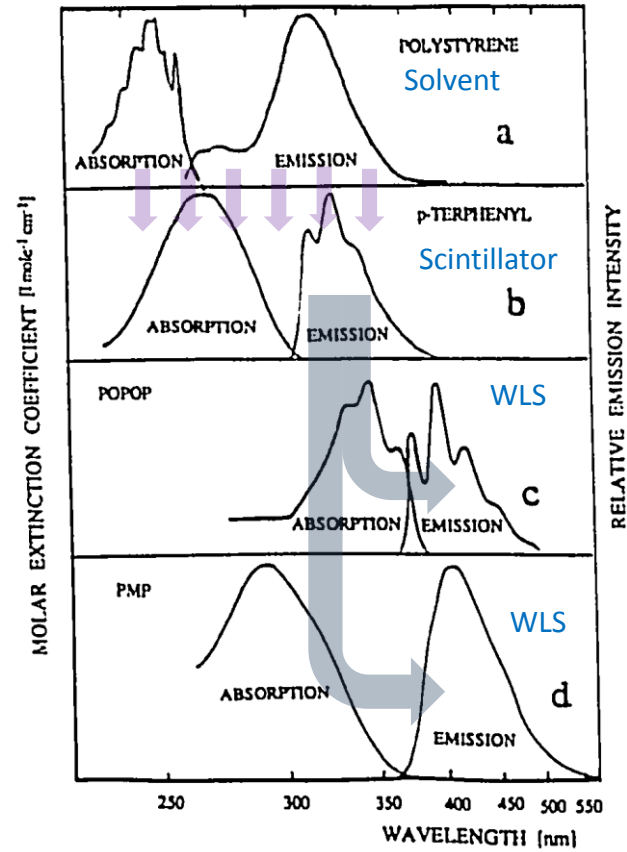

How to obtain higher gain (= single photon detection) without suffering from excessive noise ?

- Operate APD cell in Geiger mode (= full discharge), however with (passive/active) **quenching**.
- Photon conversion + avalanche short circuit the diode. A single photon (or anything else) is sufficient!

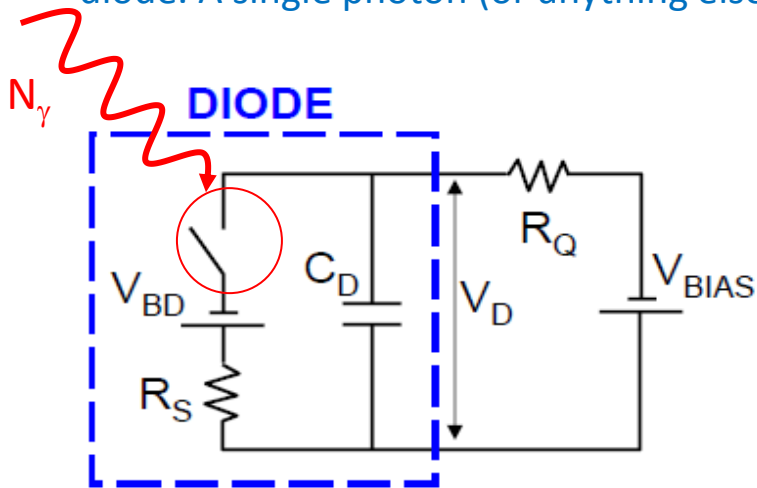

- A single-cell GM-APD is just a **binary** device (=switch).
- Info on N_γ is lost in the Geiger avalanche.
- It will become more interesting when we combine many cells in one device ...

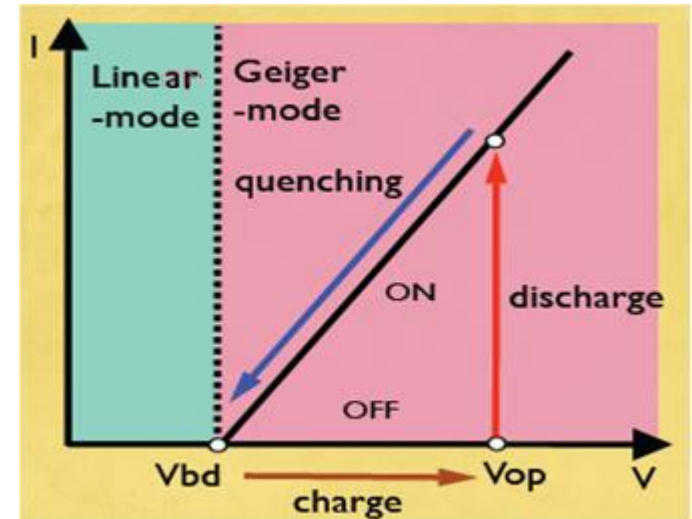
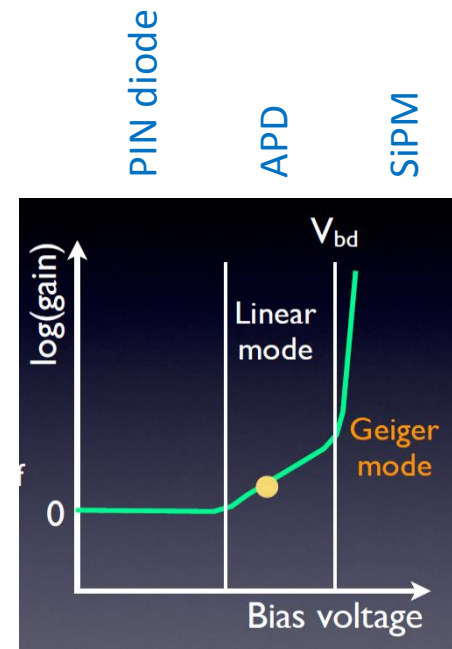

Signal characteristics and Gain of a single SiPM cell

The avalanche formation is intrinsically very fast, because confined to a small space ($\sim \mu\text{m}$)

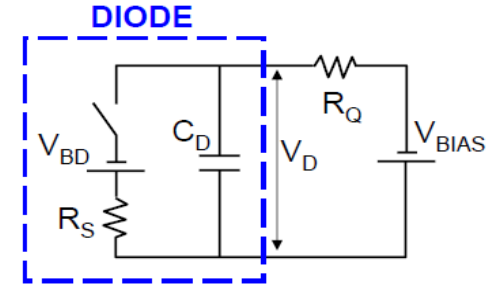
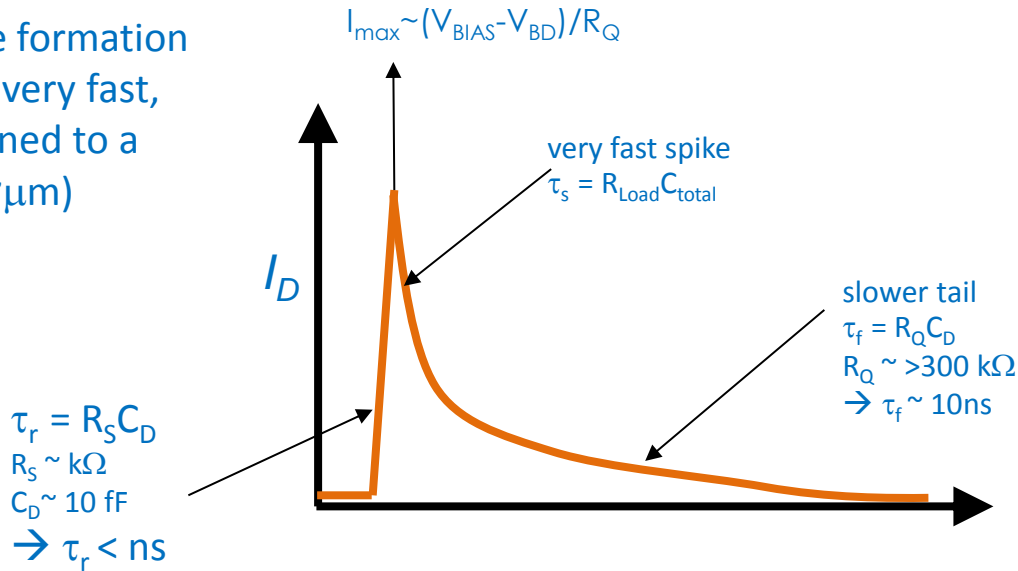

$$\text{Gain} = Q / e = \underbrace{(V_{\text{BIAS}} - V_{\text{BD}})}_{\Delta V \text{ (overvoltage)}} C_D / e$$

C_D scales with cell surface (and inversely with the thickness of the avalanche region)

- $G \sim 10^5 - 10^7$ at rel. low bias voltage ($< 100 \text{ V}$)
- dG/dT and dG/dV similarly critical as for APD.

Concentration of 2nd fluor halved

Kuraray **SCSF-77** 250microns

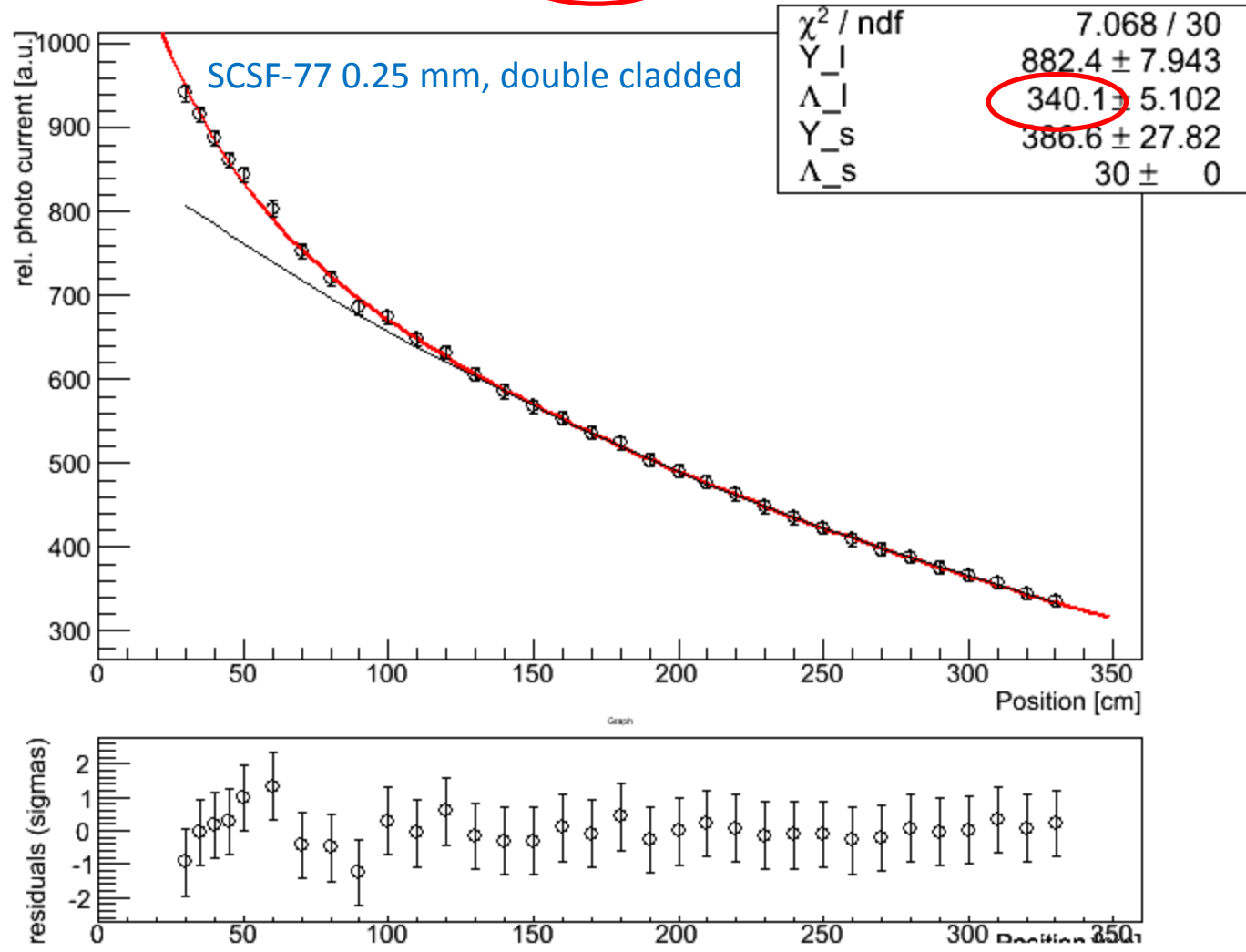

Diameter double; 250 → 500 μm

Kuraray 500microns

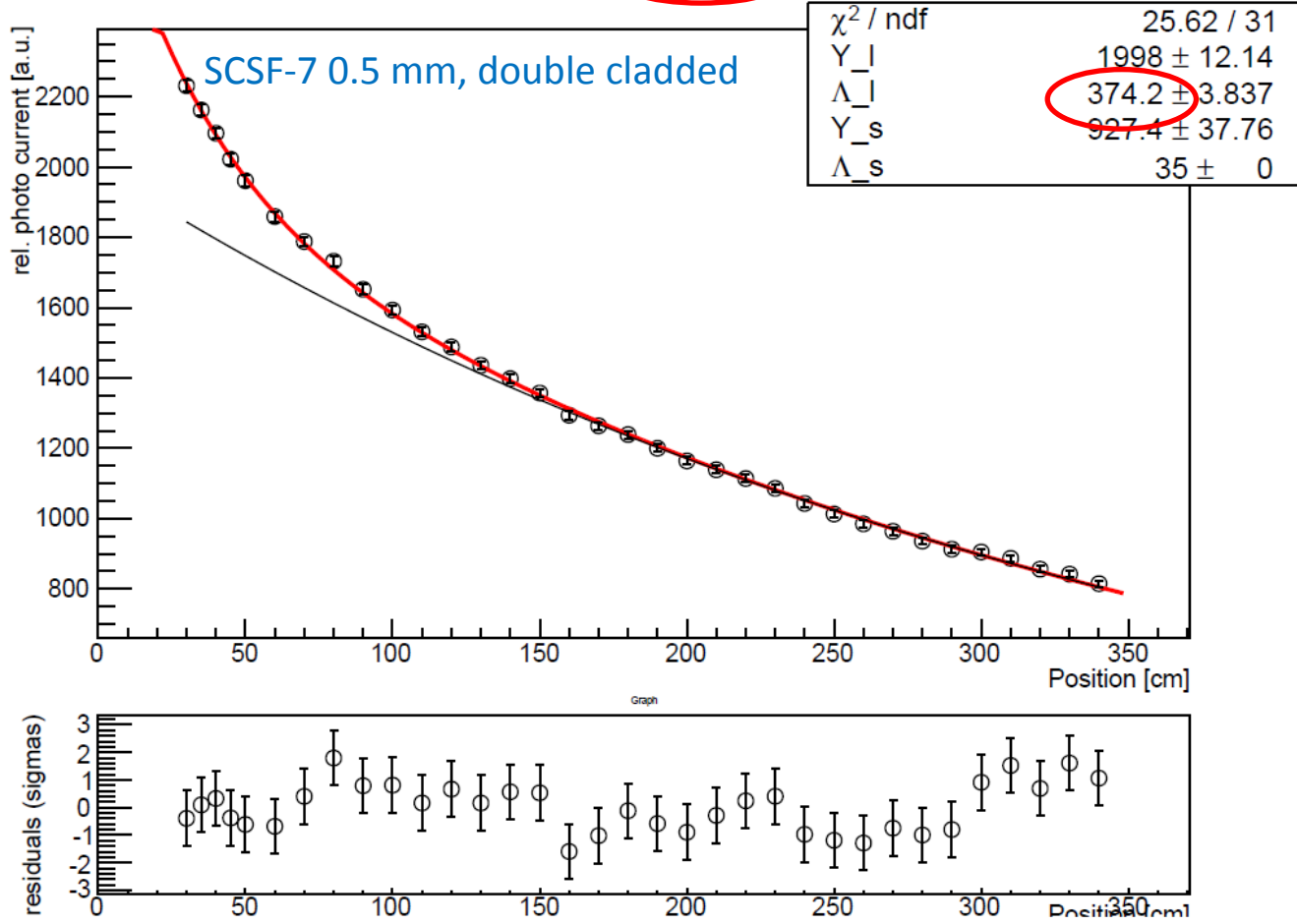

Special test fibre with single fluor formulation

Saint_Gobain_BCF9955_spool1

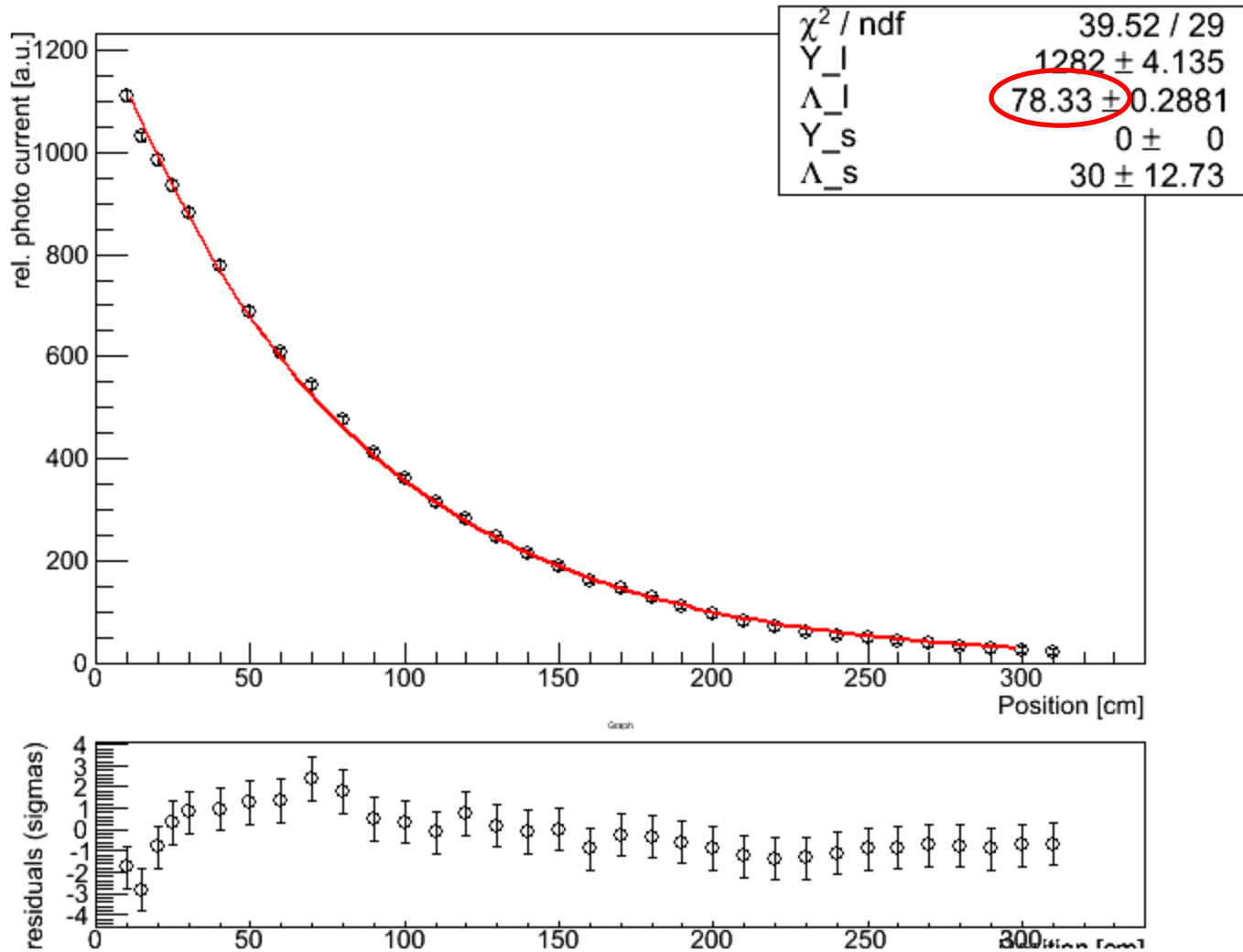

Current M.C. model of the relative photoelectron yield

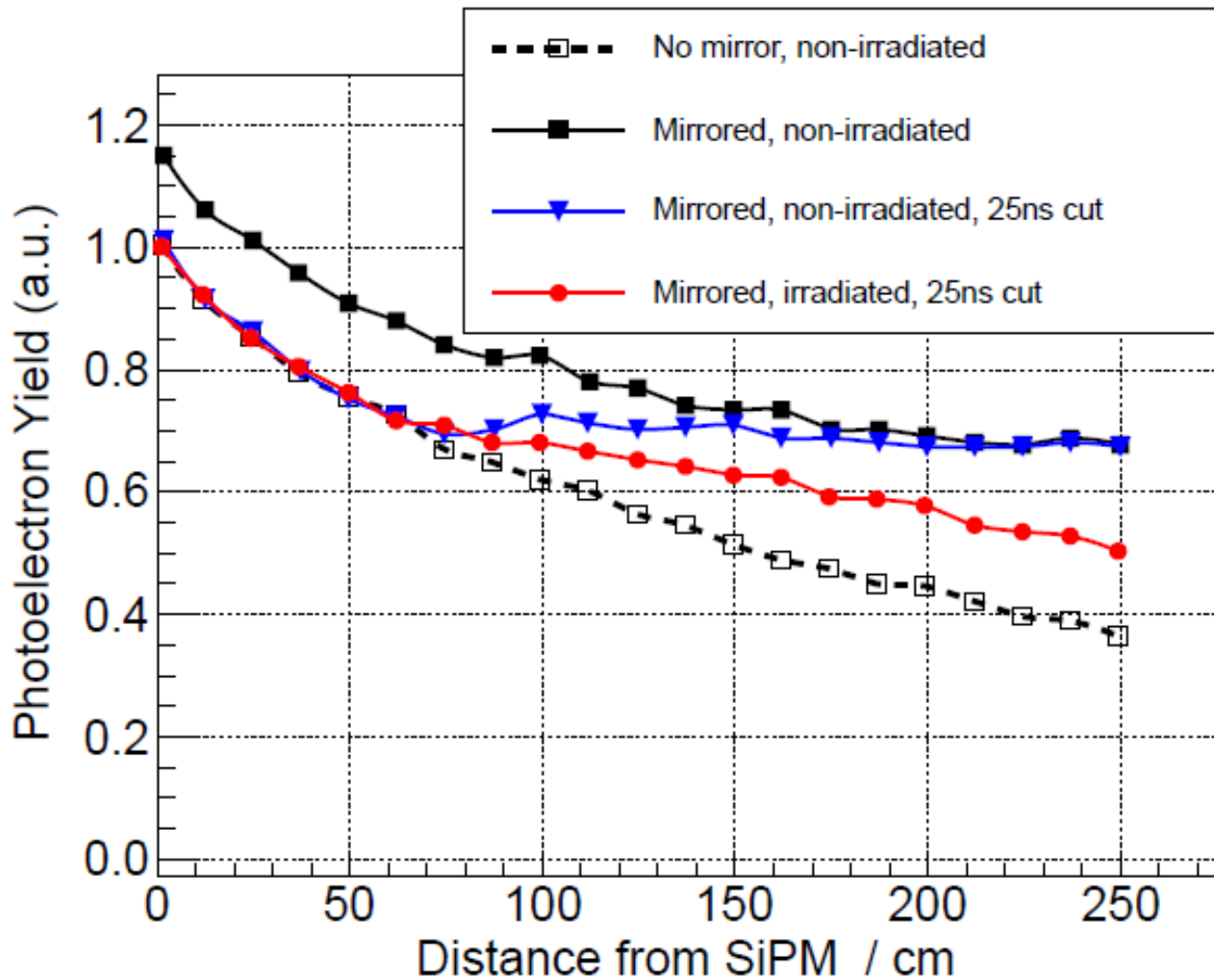

LHCb track types

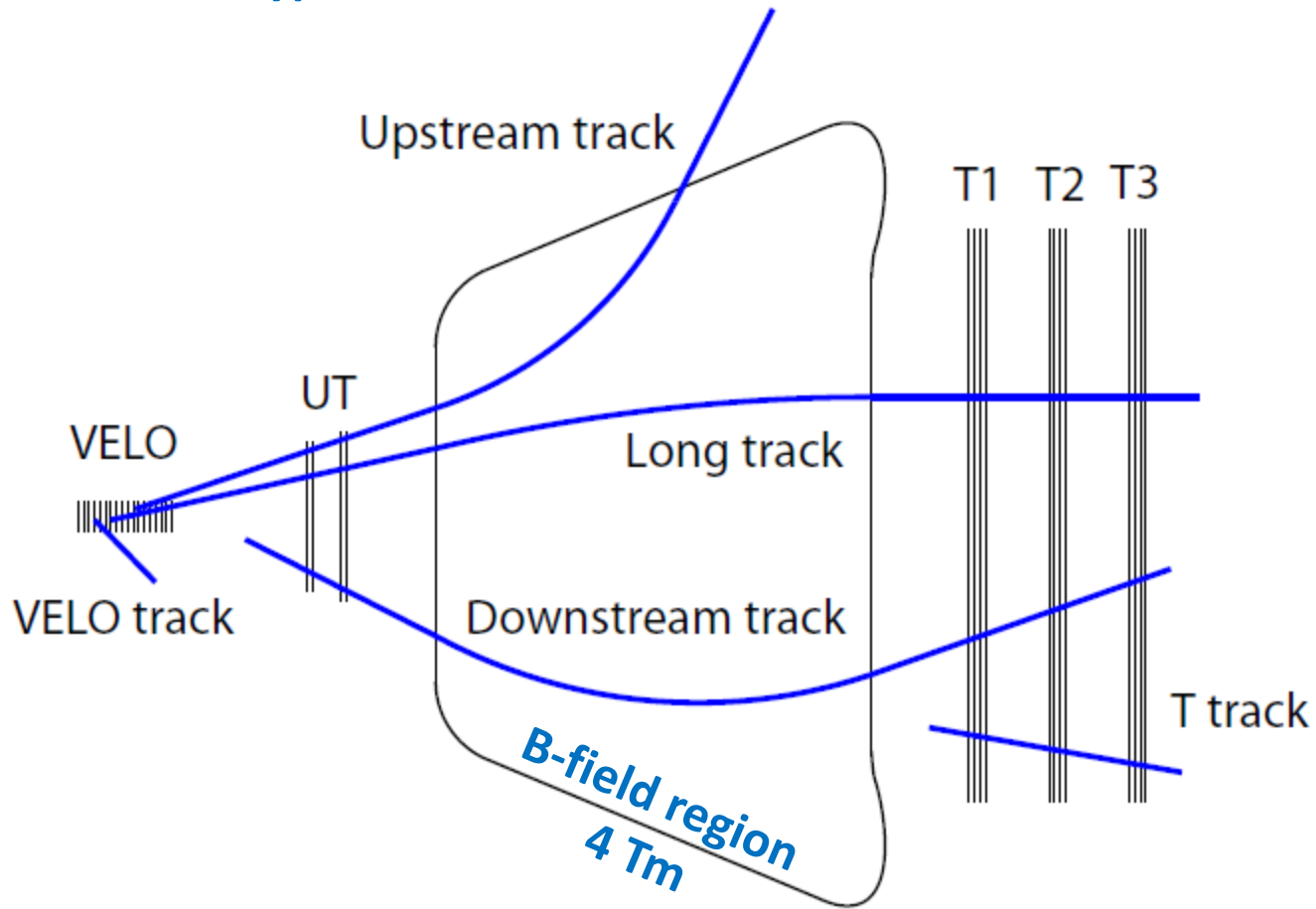

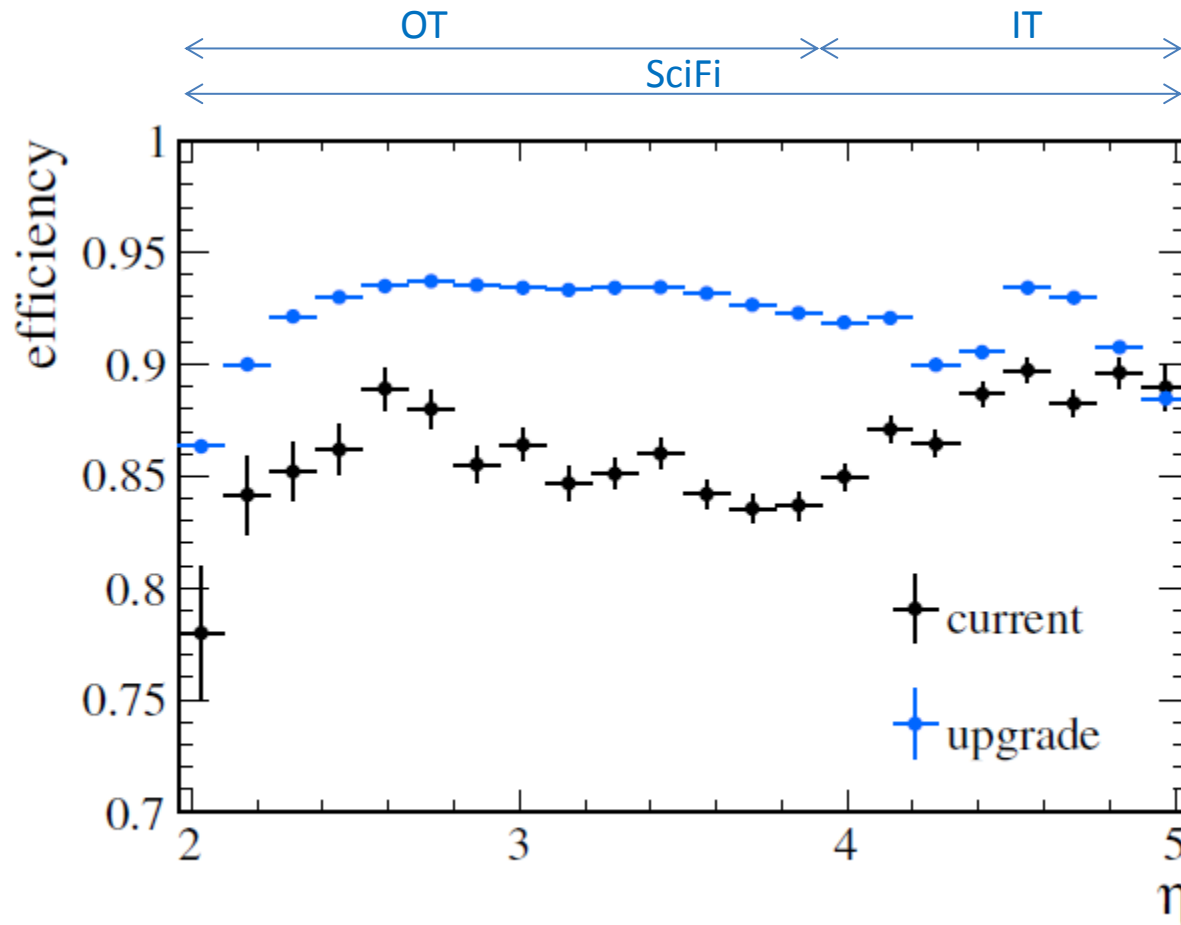

Figure 4.5: ~~Ghost rate and~~ efficiency of the Forward pattern recognition algorithm on samples of simulated $B_s \rightarrow \phi\phi$ events in upgrade running conditions at $\nu = 7.6$, for the upgrade and the current detector. For the efficiency a cut of the track momentum of $p > 5$ GeV/c is applied.